

**SISTEMI OPERATIVI** |  
PER L'ARREDO INTELLIGENTE

**ivm**  
*since 1948*

IVM esprime un'identità sempre più focalizzata nel contesto del PROGETTO proiettandosi, attraverso le sue scelte, in prima linea negli scenari contemporanei e futuri dell'arredamento per l'ufficio. Un design elegante in accordo con minimalismo estetico e forte valenza tecnologica.

Design e concretezza quindi, in una proposta di catalogo completa. Quella che fa di IVM "un'Azienda di progetto".

Questo volume è dedicato ai SISTEMI OPERATIVI INTELLIGENTI.

IVM embraces an identity that is making a real mark as a strong player in the PROJECTS area, launching itself into the forefront of contemporary and future office furniture settings through its choices. Tasteful design united with visual minimalism and bold technological appeal.

Design and substance, therefore, to provide complete solutions. The concept that makes IVM a "project-based Company".

This publication focuses on the SMART DESKING SYSTEMS.

IVM exprime une identité toujours plus forte dans le cadre de la CONCEPTION offerts également sur le marché en se projetant, à travers ses choix, sur le devant de la scène actuelle et future du mobilier de bureau. Un design élégant en accord avec le minimalisme esthétique et la forte valeur technologique.

Le design s'allie au concret et offre des solutions complètes. C'est ce qui fait d'IVM « une entreprise spécialisée dans la conception ».

Ce volume est consacré aux SYSTÈMES OPÉRATIONNELS INTELLIGENTS.

6	IL PROGETTO IVM
7	360° DI SCELTE INTELLIGENTI
8	QUALITÀ
9	MOOD BOARD
10	PROGETTUALITÀ
11	TECNOLOGIA&DESIGN
12	GREEN PHILOSOPHY
15	L'UFFICIO INTELLIGENTE DIVENTA REALTÀ
16	APPROFONDIAMO IL MONDO IOT
20	SISTEMI OPERATIVI PER L'ARREDO INTELLIGENTE

# SISTEMI OPERATIVI

PER L'ARREDO INTELLIGENTE



[ivmoffice.com](http://ivmoffice.com)

## il PROGETTO IVM

IVM propone un approccio in cui il prodotto è la massima espressione per interpretare un PROGETTO. Non basta "riconoscersi" nel prodotto - che è certamente fondamentale - ma è necessario anche affiancare il Cliente nella completa comprensione e soddisfazione dei suoi bisogni che abbracciano tematiche funzionali, ma anche quelle del benessere, della produttività, dell'ambientazione, dello stile e del design.

In the IVM approach, the product is the perfect expression to interpret a PROJECT. It's not enough to just identify with the project - although that is essential - it is also necessary to support Customers so they can be fully aware of their needs and how we can meet them. These needs encompass functions but also wellbeing, productivity, environment, style and design.

IVM propose une approche où le produit est la meilleure expression pour interpréter un PROJET. Il ne suffit pas de « se reconnaître » dans le produit. C'est bien sûr fondamental, mais il faut également accompagner le client tout au long de la compréhension et de la satisfaction de ses exigences. Celles-ci concernent non seulement les aspects fonctionnels, mais aussi ceux du bien-être, de la productivité, de l'environnement, du style et du design.

### QUALITÀ QUALITY - QUALITE



Made in Italy



Materiali  
Materials  
Matériaux



Green Philosophy

### PROGETTUALITÀ PLANNING CONCEPT - CONCEPTION



Consulenza  
Advice  
Conseils



Innovazione  
Innovation



Servizio  
Service

### MOOD BOARD



Global Office



Finiture esclusive  
Exclusive finishes  
Finitions exclusives



Comfort

### TECNOLOGIA®DESIGN TECHNOLOGY®DESIGN - TECHNOLOGY®DESIGN



Designers



Eccellenza tecnologica  
Technological excellence  
Excellence technologique



Identità  
Identity  
Identité

# 360° DI SCELTE INTELLIGENTI

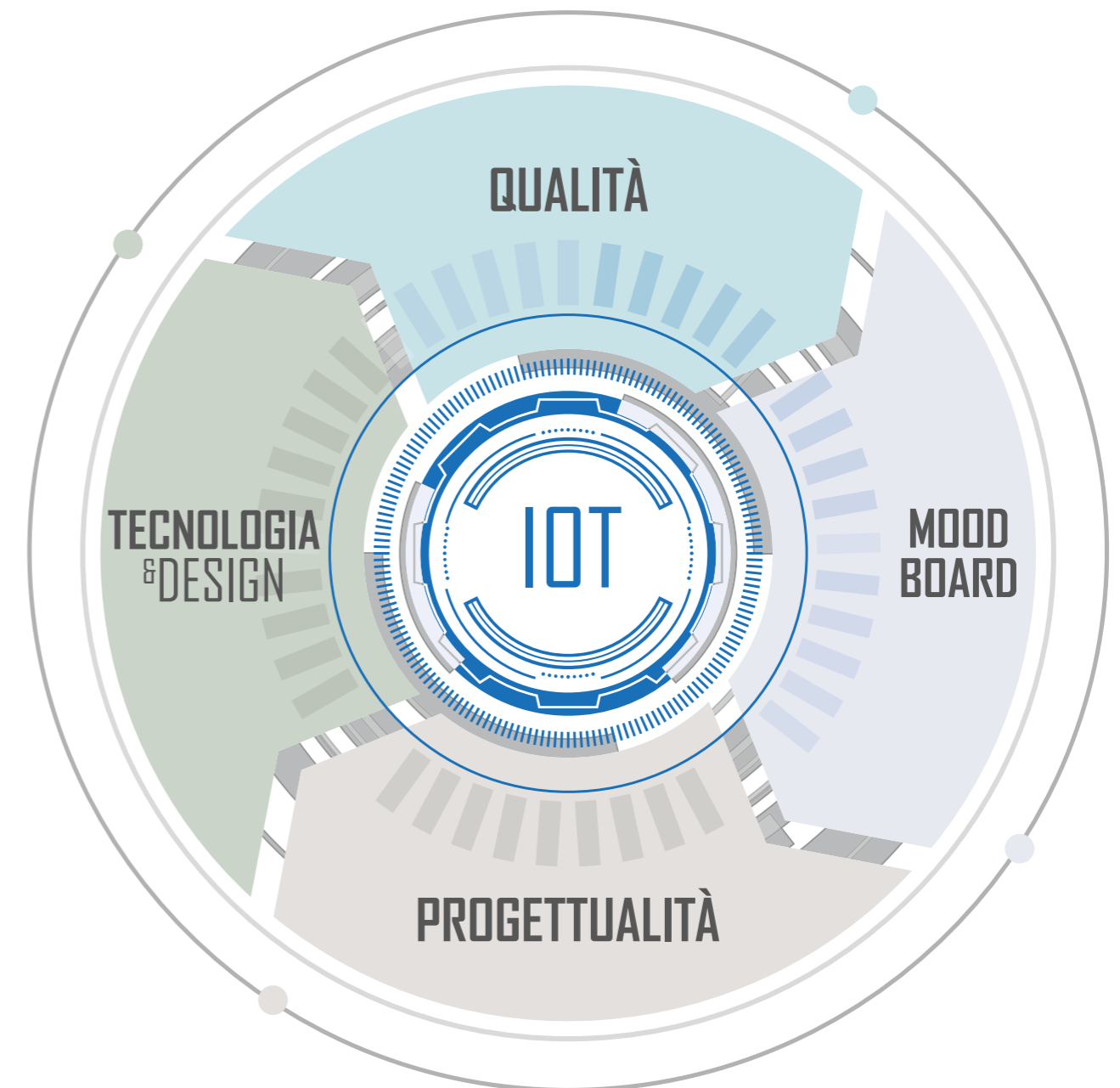

A FULL CIRCLE OF SMART CHOICES  
DES CHOIX INTELLIGENTS TOUS AZIMUTS



## QUALITÀ

PER REALIZZARE UN ARREDO DI QUALITÀ IVM RITIENE FONDAMENTALE UTILIZZARE PANNELLI PRODOTTI CON LEGNO VERGINE DI PROVENIENZA CERTIFICATA.

TO PRODUCE QUALITY FURNITURE, IVM BELIEVES IT IS FUNDAMENTAL TO USE PANELS MADE FROM VIRGIN WOOD AND OF CERTIFIED ORIGIN.

POUR RÉALISER DES MEUBLES DE QUALITÉ, IVM ESTIME DEVOIR UTILISER DES PANNEAUX PRODUITS AVEC DE LA LAINE VIERGE DE PROVENANCE CERTIFIÉE.



SEZIONE PANNELLO CARB2

IVM utilizza per il 100% della sua produzione pannelli rispondenti alla normativa **CARB P2 TSCA Title VI compliant** per la bassa emissione di formaldeide, pannelli cioè adatti ad ambiti di applicazione con severi standard in fatto di emissioni. Ciò significa che si riducono sensibilmente i rischi derivanti da questo fattore: un grande passo per la TUTELA DELLA SALUTE.

IVM uses **CARB ATCM Phase 2 and TSCA Title VI compliant** panels for 100% of its production due to their low formaldehyde emission, making them suitable for use in areas with stringent emission standards. This significantly reduces the risks arising from this factor: a big step towards PROTECTING HEALTH.

IVM utilise pour l'ensemble de sa production des panneaux conformes aux normes **CARB P2 et TSCA Title VI** sur les faibles émissions de formaldéhyde, c'est-à-dire des panneaux adaptés à des domaines d'application prévoyant des critères très sévères en matière d'émissions. Cela signifie que les risques découlant de ce facteur sont considérablement réduits : un grand pas en avant pour la PROTECTION DE LA SANTÉ.

La tutela della salute è il primo\_ma non l'unico\_motivo per cui IVM utilizza questi pannelli. Questa scelta significa anche:

- maggiore tenuta di viti, cerniere, giunti
- maggiore resistenza al peso e agli urti
- maggiore resistenza all'usura del tempo

IVM utilizza per il rivestimento dei pannelli una carta di 120g/m<sup>2</sup>. Il doppio rispetto a quella utilizzata per rivestire un pannello standard. Questa scelta significa anche:

- una sensazione tattile di grande naturalezza
- una maggiore resistenza all'usura
- una 'evidente' qualità estetica

IVM uses these panels first and foremost to protect health but that's not the only reason.

This choice means:

- better grip for screws, hinges, joints
- greater resistance to weight and impact
- greater resistance to wear and tear

IVM uses paper weighing 120 g/m<sup>2</sup> to cover its panels. Double compared with a standard panel. This choice also means:

- an extremely natural feel
- greater resistance to wear and tear
- clear aesthetic quality

La protection de la santé est la première – mais pas la seule – raison pour laquelle IVM utilise ces panneaux. Ce choix comporte:

- une meilleure tenue des vis, des charnières et des joints
- une meilleure résistance au poids et aux chocs
- une meilleure résistance à l'usure du temps

Pour le revêtement des panneaux, IVM utilise du papier de 120 g/m<sup>2</sup>, le double de celui qui est utilisé pour revêtir les panneaux standards. Cette mesure garantit :

- une sensation tactile d'un grand naturel
- une meilleure résistance à l'usure
- une qualité esthétique « manifeste »

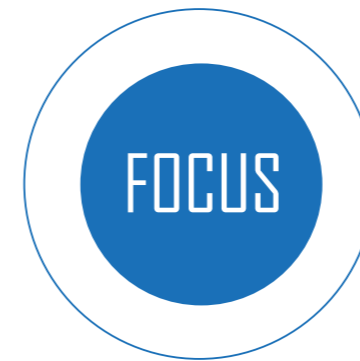

## MOOD BOARD

GESTI SAPIENTI CHE TRACCIANO SULLA CARTA I CONTORNI DI NUOVE IDEE, NUOVI PROGETTI, NUOVE SOLUZIONI.

Suggerzioni che raccontano la capacità, la volontà di andare oltre il prodotto per rappresentare una vision d'ufficio nella sua complessità e interezza; ambienti che riescono a coniugare momenti di condivisione e riservatezza, funzionalità, armonia e stile.

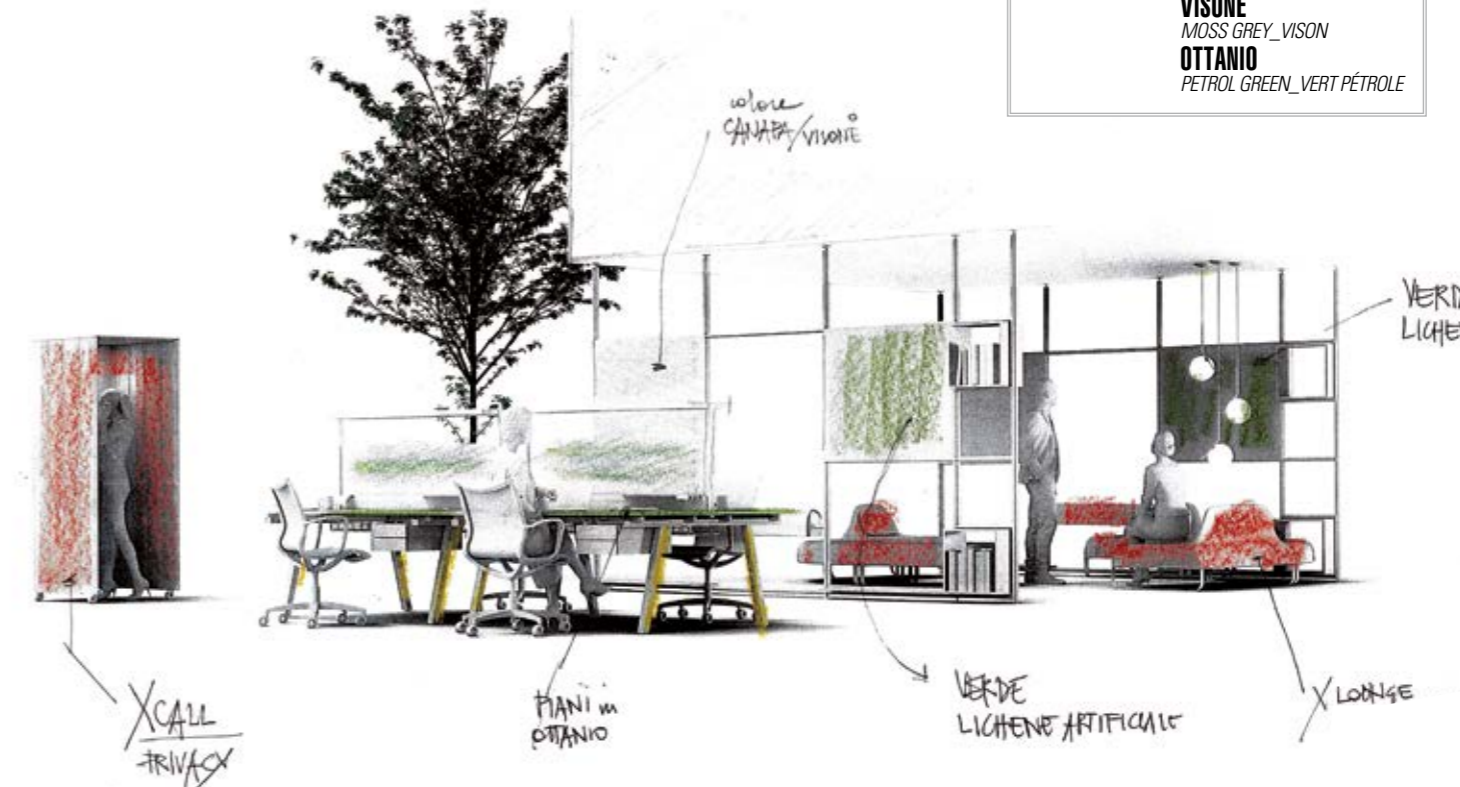

ARTFUL STROKES ON PAPER SHAPING THE LINES OF NEW IDEAS, NEW PROJECTS, AND NEW SOLUTIONS.

Sketches that convey the capacity and determination to transcend the product and express a vision of the office in all its complexity and entirety ; spaces that successfully bring together opportunities for sharing and privacy, plus functionality, harmony and style.

DES GESTES HABILES QUI TRACENT SUR LE PAPIER LES CONTOURS DE NOUVELLES IDÉES, DE NOUVEAUX PROJETS, DE NOUVELLES SOLUTIONS.

Des suggestions qui racontent la capacité, la volonté d'aller au-delà du produit pour représenter une vision du bureau dans sa complexité et son intégralité ; des environnements qui combinent des moments de partage et de confidentialité, de fonctionnalité, d'harmonie et de style.



## PROGETTUALITÀ

LA PROGETTAZIONE DELL'UFFICIO:  
UN ASPETTO DA NON SOTTOVALUTARE NELLA STRATEGIA AZIENDALE.  
ANZI, DA PIANIFICARE CON CURA.

IVM esprime un'identità sempre più focalizzata nel contesto del PROGETTO proiettandosi, attraverso le sue scelte, in prima linea negli scenari contemporanei e futuri dell'arredamento per l'ufficio.

**ORGANIZZARE - SUDDIVIDERE - ISOLARE - ACCOGLIERE - AGGREGARE - COMUNICARE:** sono solo alcuni degli aspetti da considerare nella progettazione di un ambiente ufficio che vanno ad integrarsi con specifiche normative internazionali e con gli standard di qualità più severi, per garantire spazi operativi in cui si possa lavorare e vivere bene.



OFFICE DESIGN IS AN IMPORTANT ASPECT OF THE COMPANY'S STRATEGY. ACTUALLY, IT REQUIRES CAREFUL PLANNING.  
The IVM identity is focused increasingly on the context of DESIGN, and its decisions have propelled it to the forefront of the contemporary and future world of office furniture.

**ORGANISE - DIVIDE - ISOLATE - WELCOME - UNITE - COMMUNICATE:** these are just some of the aspects to take into consideration when planning and configuring office environments. They complement specific international regulations and the strictest standards of quality to assure work spaces for a positive experience and thriving workplace.

LA CONCESSION DU BUREAU EST L'UN DES ASPECTS QU'IL NE FAUT PAS SOUS-ÉVALUER DANS LA STRATÉGIE DE L'ENTREPRISE.  
AU CONTRAIRE, IL FAUT LA PLANIFIER AVEC SOIN.

IVM esprime un'identità de plus en plus concentrée sur le PROJET en se projetant, à travers ses choix, en première ligne dans le monde du mobilier de bureau d'aujourd'hui et de demain.

**ORGANISER - SUBDIVISER - ISOLER - ACCUEILLIR - RÉUNIR - COMMUNIQUER :** ce sont quelques-uns des aspects à prendre en compte dans la conception d'un espace destiné au bureau, qui s'ajoutent à des réglementations internationales spécifiques et aux normes de qualité les plus sévères, pour garantir des espaces où il est possible de bien travailler et de bien vivre.



## TECNOLOGIA & DESIGN

IL DESIGN ESSENZIALE SI CONIUGA ALLO SPIRITO DI SISTEMI OPERATIVI RICCHI DI  
TECNOLOGIE AL SERVIZIO DELLA PERSONA.

Scrivanie regolabili in altezza, piani sliding, accessori e pannelli fonoassorbenti per creare un ambiente di lavoro pratico ed ergonomico.



THE ESSENTIAL DESIGN MATCHES THE SPIRIT OF TECHNOLOGY-BASED DESKING SYSTEMS AT THE SERVICE OF PEOPLE.  
Height-adjustable desks, sliding tops, accessories and sound-absorbent panels to create a practical, ergonomic work environment.

LE DESIGN ESSENTIEL S'ALLIE À L'ESPRIT DE SYSTÈMES OPÉRATIONNELS TRUFFÉS DE TECHNOLOGIE AU SERVICE DES PERSONNES.  
Des bureaux réglables en hauteur, des plateaux coulissants Sliding, des accessoires et des panneaux acoustiques pour créer un environnement de travail pratique et ergonomique.



## GREEN PHILOSOPHY

Essere Green per IVM significa non dimenticare mai che tutto quello che facciamo trae origine da una delle materie prime più nobili e importanti: il legno.

Ogni nostro pannello nasconde una qualità che non si vede ma che rende onore a questo dono straordinario che riceviamo dalla natura.

Lo facciamo con rispetto e attenzione, con materie prime certificate, processi sostenibili e la riduzione totale di qualsiasi elemento tossico o nocivo.

Cerchiamo di dare il nostro contributo per un mondo migliore. Perché questo mondo è la casa di tutti.

Quando un'azienda produce chiede qualcosa al Pianeta, per questo deve trovare il modo migliore per restituire quello che ha avuto. Bisogna sempre ricordarsi che tutto ciò che facciamo non riguarda solo noi stessi: se ci accorgiamo che una nostra scelta può danneggiare il pianeta abbiamo il dovere di trovare una strada diversa, fatta di rispetto e amore per ciò che ci circonda.

Ci immaginiamo un futuro dove l'innovazione, le nuove tecnologie e una filosofia di vita più consapevole possano gettare le basi per una vita migliore su questo pianeta.

Un futuro dove le risorse vengano utilizzate al meglio per realizzare prodotti e soluzioni di nuova generazione, più sostenibili, più utili, più preziose.

Il mondo di domani si costruisce oggi e noi stiamo facendo del nostro meglio per progettare il nostro futuro, senza dimenticare mai quello che siamo stati.



For IVM, being "Green" means never forgetting that everything we do originates from one of the noblest and most important raw materials in the world: wood.

Each panel conceals a quality that cannot be seen, but that honours this extraordinary gift given to us by nature.

We treat it with respect and care, making sure to use certified raw materials and sustainable processes, while reducing any toxic or harmful elements.



We try to make our contribution to a better world. Because this world is everyone's home. When a company produces, it asks the Planet for something, so we must find the best way to give back what we took.

We must never forget that everything we do is not only about us: if we realise that one of our choices can harm or damage the planet, then we must find another way of doing it, one that loves and respects everything that surrounds us.



We imagine a future where innovation, new technologies and a more mindful philosophy of life can lay the foundations for a better future on this planet.

A future where resources are used in the best way possible to create cutting-edge products and solutions that are more sustainable, more useful and more precious.

The world of tomorrow is built today, and we are doing our best to plan our future, without ever forgetting where we came from.

Pour IVM, être vert, c'est ne jamais oublier que tout ce que nous faisons provient d'une des matières premières les plus nobles : le bois.

Chacun de nos panneaux recèle une qualité qui, bien qu'invisible pour les yeux, rend hommage à ce don extraordinaire que nous fait la nature.

Nous accueillons avec égard les matières premières certifiées que nous transformons avec respect, en suivant des processus durables, de manière à réduire totalement tout élément toxique ou nocif.

Nous agissons de notre mieux pour un monde meilleur. Parce que ce monde n'est autre que notre maison à tous.

Quand une entreprise produit, elle demande quelque chose à la planète. Elle doit donc trouver le meilleur moyen de lui restituer ce qu'elle a reçu. Nous nous devons de nous souvenir que tout ce que nous faisons est l'affaire de tous, dans le sens où, si nous nous apercevons que notre choix peut nuire à la planète, nous devons modifier notre stratégie pour privilégier le respect et l'amour de notre environnement.

Pour nous, demain est fait d'innovation, de nouvelles technologies et d'une philosophie de vie plus clairvoyante en mesure de jeter les bases d'une vie meilleure sur cette planète.

Un futur où les ressources sont utilisées au mieux pour réaliser des produits et des solutions de nouvelle génération, plus durables, plus utiles, plus précieuses.

Le monde de demain se construit aujourd'hui et nous sommes en train de faire le maximum pour projeter notre avenir sans jamais oublier ce que nous avons été.



## I NOSTRI 7 VALORI GREEN

1

### PASSIONE

Crediamo nel valore della nostra identità. L'identità di un'azienda italiana che racconta a tutto il mondo la sua passione per il design.

### PASSION

We believe in the value of our identity. The identity of an Italian company that for over 70 years has been telling the whole world about its passion for office furniture design.

2

### MADE IN ITALY

Siamo orgogliosi di garantire un processo produttivo totalmente Made in Italy.

### MADE IN ITALY

We are proud to guarantee a production process carried out entirely in Italy.

3

### FUTURO

Da sempre investiamo in materiali innovativi e tecnologie a basso impatto ambientale. Costruire il nostro domani significa fare le scelte giuste oggi.

### FUTURE

We have always invested in innovative materials and technologies with low environmental impact. Building our tomorrow means making the right choices today.

4

### BENESSERE

Progettiamo soluzioni e ambienti di lavoro che pongono al centro la persona e le sue esigenze.

### WELLBEING

We design solutions and work environments that focus on people and their needs.

5

### INNOVAZIONE

Investiamo costantemente nella ricerca di nuove tecnologie che offrano nuove prospettive nel campo del design per l'arredo ufficio.

### INNOVATION

We constantly invest in the research of new technologies that offer a new approach to office furniture design.

6

### ENERGIA GREEN

Dal 2011 la nostra sede produttiva genera e utilizza energia pulita grazie all'impianto fotovoltaico.

### GREEN ENERGY

Since 2011, our production site has been generating and using clean energy thanks to a photovoltaic system.

7

### IMPEGNO

La nostra filosofia Green ci impone di non accontentarci mai. Scegliamo sempre percorsi sostenibili che pongano al centro l'attenzione alla salute e la protezione dell'ambiente.

### COMMITMENT

Our "Green" philosophy is based on getting better and never resting on our laurels. We always choose sustainable paths that focus on health and environmental protection.



# IOT

Nasce "IOT- IVM Office Technology" che sfrutta le nuove tecnologie e l'Internet delle Cose per dar vita ad una nuova generazione di soluzioni per l'ufficio di domani

Il futuro non è un orizzonte lontano che ci aspetta, ma un progetto che si costruisce nel presente da protagonisti. Un futuro dove l'ufficio diventa intelligente, interattivo, connesso. Un ambiente dove le persone dialogano con gli oggetti e gli oggetti comunicano tra loro per dare una risposta nuova alle mutate esigenze d'impresa sui temi della produttività, del benessere, dei rapporti umani.

Introducing "IOT - IVM Office Technology" that leverages new technologies and the Internet of Things to create a new generation of solutions for tomorrow's offices.

Naissance du concept « IOT - IVM Office Technology » qui tire parti des nouvelles technologies et de l'Internet des objets afin de lancer une nouvelle génération de solutions pour le bureau de demain.

The future isn't just a distant horizon waiting for us, it's a project that is built in the here and now by key players. A future where offices become smart, interactive, connected. An environment where people engage with objects and objects communicate with each other to give a new response to changed business requirements in terms of productivity, wellbeing and human relations.

Le futur n'est pas un horizon lointain qui nous attend, mais un projet créé dans le présent par des protagonistes. Un futur où le bureau devient intelligent, interactif, connecté. Un monde où les personnes dialoguent avec les objets et les objets communiquent entre eux pour apporter une réponse novatrice aux exigences évolutives de l'entreprise en matière de productivité, de bien-être, de rapports humains.

## DA SOTTOLINEARE 3 ASPETTI ESCLUSIVI

IOT - IVM Office Technology non propone "scrivanie" ma organizza **SOLUZIONI D'ARREDO INTELLIGENTI**: dalle **POSTAZIONI OPERATIVE** alle **MEETING ROOM**.

IOT - IVM Office Technology è **COMPATIBILE con TUTTI I SISTEMI OPERATIVI** del catalogo **IVM**.

Le postazioni operative IOT - IVM Office Technology possono essere **"rese" IOT anche in un secondo momento**, in base alle **ESIGENZE** di SVILUPPO del Cliente. Rapidamente e con estrema semplicità di intervento.

### STRESSING THREE EXCLUSIVE ASPECTS...

IOT - IVM Office Technology doesn't offer "desks", it organises **SMART FURNITURE SOLUTIONS**: from **WORKSTATIONS** to **MEETING ROOMS**.

IOT - IVM Office Technology is **COMPATIBLE with ALL THE DESKING SYSTEMS** listed in the **IVM** catalogue.

The IOT - IVM Office Technology workstations can also be **"upgraded to" IOT after installation**, to suit the Customer's **DEVELOPMENT NEEDS**. Very quickly and extremely easily.

### 3 ASPECTS EXCLUSIFS À SOULIGNER...

IOT - IVM Office Technology ne propose pas des « bureaux » mais organise des **SOLUTIONS DE MOBILIER INTELLIGENTES** : des **POSTES DE TRAVAIL** aux **SALLES DE RÉUNION**.

IOT - IVM Office Technology est **COMPATIBLE avec TOUS LES SYSTÈMES OPÉRATIONNELS** du catalogue **IVM**.

Les postes de travail IOT - IVM Office Technology peuvent également être **« convertis » en postes IOT dans un deuxième temps**, en fonction des **EXIGENCES** de DÉVELOPPEMENT du client. Et ce, rapidement et très facilement.

Guarda il video...



Watch the video...



# L'UFFICIO INTELLIGENTE DIVENTA REALTÀ

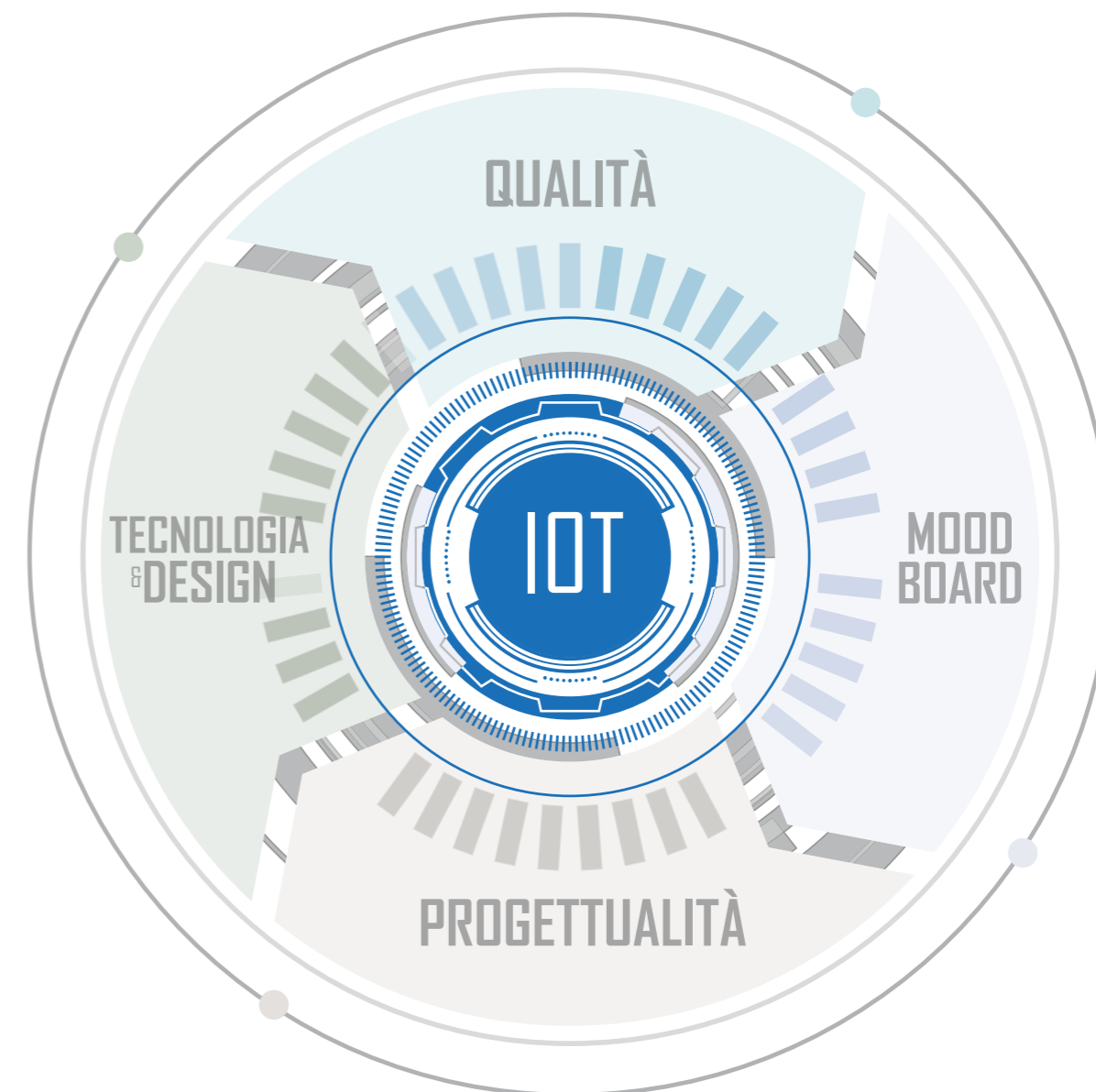

THE SMART OFFICE IS HERE  
LE BUREAU INTELLIGENT DEVIENT UNE RÉALITÉ



## APPROFONDIAMO il "mondo" IOT - IVM Office Technology

LET'S EXPLORE THE IOT - IVM OFFICE TECHNOLOGY "WORLD"  
VOYONS LE « MONDE » IOT - IVM OFFICE TECHNOLOGY D'UN PEU PLUS PRÈS

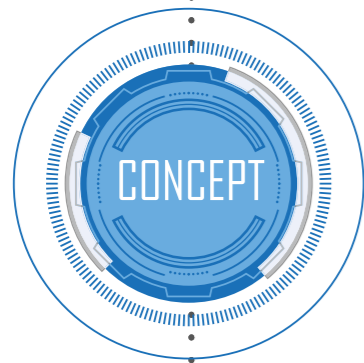

### UTILIZZO PIÙ EFFICIENTE DELLO SPAZIO

MORE EFFICIENT USE OF SPACES  
UTILISATION PLUS EFFICACE DE L'ESPACE



- PRENOTARE UNA POSTAZIONE
- INDIVIDUARE LA POSTAZIONE LIBERA
- OCCUPARE ED UTILIZZARE LA POSTAZIONE

BOOK A WORKSTATION - LOCATE THE FREE WORKSTATION  
OCCUPY AND USE THE WORKSTATION  
RÉSERVER UN POSTE DE TRAVAIL - IDENTIFIER LE POSTE LIBRE  
OCCUPER ET UTILISER LE POSTE

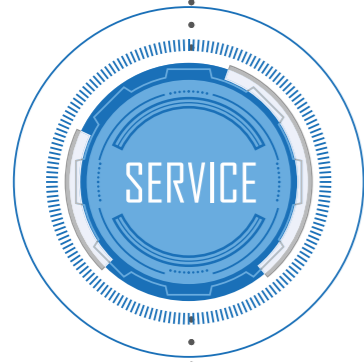

- PIANIFICAZIONE ed INSTALLAZIONE
- START UP e FORMAZIONE

PLANNING and INSTALLATION - START-UP and TRAINING

Scopri di più sull'app P4Y



Discover more about the P4Y app

En savoir plus sur l'appli P4Y



## L'UPGRADE? QUANDO VUOI TU

UPGRADE WHENEVER YOU LIKE - L'EXTENSION QUAND VOUS VOULEZ

Le soluzioni IOT possono integrarsi in qualsiasi momento nell'ambito degli arredi d'ufficio IVM. Infatti è possibile **fare anche in un secondo momento l'upgrade IOT** alle soluzioni d'arredamento tradizionali per dar vita all'ufficio intelligente in base alle tue esigenze di sviluppo.

The IOT options can be installed in IVM office furniture environments at any time. This means **you can even upgrade to IOT after installation**, adding it to traditional office furniture to give life to the smart office on the basis of your development needs.

Les solutions IOT peuvent être intégrées à tout moment au mobilier de bureau IVM. En effet, **il est possible d'étendre dans un deuxième temps l'IOT** aux solutions d'ameublement traditionnelles pour créer le bureau intelligent en fonction de vos exigences de développement.

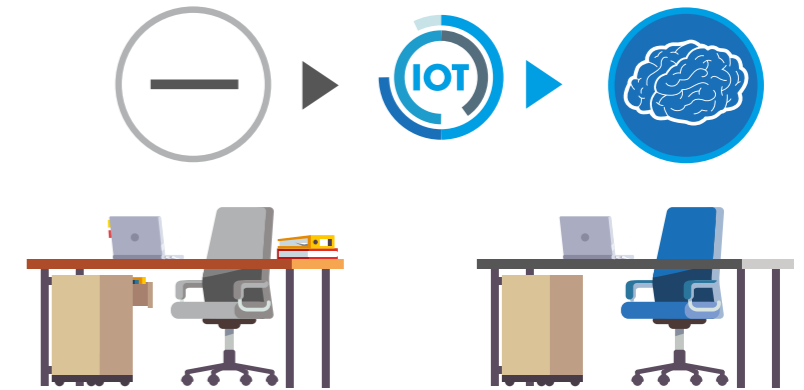

## MISSION

Ogni persona ha la possibilità di individuare da remoto attraverso l'apposita APP P4Y \_ con l'utilizzo dallo smartphone o da PC \_ una postazione o una meeting room libera, nel giorno e nell'ora definiti. Con P4Y IVM porta intelligenza e connessione nel mondo dell'ufficio, rendendo gli spazi facilmente fruibili e controllabili, migliorando l'ottimizzazione dei flussi, favorendo una migliore distribuzione delle risorse disponibili con conseguente riduzione dei costi di gestione del building.

Everyone can use the dedicated P4Y app from their smartphone or PC to find a free workstation or meeting room on the day and at the time entered remotely. With P4Y, IVM makes offices smart and connected. It's easy to use and control spaces, streamlining the flow of people for a better spread of available resources, in turn keeping down the running costs of the building.

Chaque personne a la possibilité de choisir à distance un poste de travail ou une salle de réunion libre, à la date et à l'heure souhaitées, grâce à l'appli P4Y, en utilisant un smartphone ou un PC. Avec P4Y, IVM porte l'intelligence et la connexion dans le monde du bureau, en rendant les espaces facilement utilisables et contrôlables, en améliorant l'optimisation des flux, en encourageant une meilleure distribution des ressources disponibles et en réduisant les coûts de gestion des bâtiments.

## COME FUNZIONA L'APP P4Y PLACE 4 YOU?

Per prenotare una postazione o una meeting room consultare quindi l'**APP P4Y** che proporrà l'intero layout degli uffici, visualizzando tutte le postazioni o le meeting room disponibili. La piattaforma è progettata per visualizzare in tempo reale l'occupazione degli spazi, consentendo agli utenti di verificare con immediatezza ed estrema semplicità quali postazioni sono libere e quali sono già occupate.

## HOW THE P4Y PLACE4YOU APP WORKS?

To book a workstation or meeting room, you just need to consult **P4Y**, which will bring up the entire layout of the offices, displaying all the available workstations and meeting rooms. **P4Y** is designed for real time display of space occupation so users can immediately and very simply verify which workstations are free and which ones are already occupied.

## COMMENT FONCTIONNE L'APPLI P4Y PLACE4YOU?

Pour réserver un poste de travail ou une salle de réunion, il suffit de consulter l'**appli P4Y** qui proposera toute la disposition des bureaux, en affichant tous les postes de travail et les salles de réunion disponibles. L'**appli P4Y** est conçue pour afficher en temps réel l'occupation des espaces, pour que les utilisateurs puissent vérifier immédiatement et facilement quels postes sont libres et ceux qui sont déjà occupés.

## CUSTOMER SERVICE

La partnership di IVM con Dgroove riveste un ruolo fondamentale nella gestione di ogni progetto IOT\_IVM Office Technology. Il Cliente sarà quindi seguito in ogni fase da un team di consulenti del settore IT costantemente aggiornato sulle tecnologie più innovative richieste dal mercato.

The IVM partnership with Dgroove plays a fundamental role in managing every IOT - IVM Office Technology project. So, Customers are assisted by a team of IT consultants who remain constantly abreast of the most innovative technologies demanded by the market.

Le partenariat d'IVM avec Dgroove joue un rôle fondamental dans la gestion de chaque projet IOT - IVM Office Technology. Le client sera ensuite suivi dans chaque phase par une équipe de consultants du secteur IT se tenant constamment à jour sur les technologies les plus innovantes requises par le marché.

# IOT. IVM OFFICE TECHNOLOGY

## SISTEMI PER L'ARREDO INTELLIGENTE

Tecnologia  
emozionale...

SMART FURNITURE SYSTEMS  
Motivating technology...

SYSTÈMES POUR MOBILIER  
INTELLIGENT  
Technologie émotionnelle...

1

da PC  
TABLET  
SMARTPHONE

accedendo alla APP  
Place4You  
puoi velocemente  
PRENOTARE da REMOTO  
la SCRIVANIA  
o la MEETING ROOM  
che vorrai utilizzare

2



SCRIVANIE e MEETING ROOM  
SONO DOTATE DI QR CODE  
posizionato sul  
PIANO SCRIVANIA o  
VISIBILE SU MONITOR DEL TABLET  
DELLA MEETING ROOM

3

TRAMITE L'APP P4Y  
INQUADRANDO IL QR CODE  
potrai effettuare il CHECK IN  
\_se hai prenotato da remoto\_  
oppure procedere direttamente  
alla prenotazione



4

L'APP P4Y è INTEGRABILE con  
OFFICE 365 GSUITE



Questo ti permette di gestire  
le PRENOTAZIONI anche  
DIRETTAMENTE dal CALENDARIO  
AZIENDALE CONDIVISO

5

Place4You

L'APP P4Y è  
PROGETTATA PER VERIFICARE  
\_in tempo reale\_  
L'OCCUPAZIONE DEGLI SPAZI  
ATTRAVERSO LA  
VISUALIZZAZIONE  
DELL'INTERO LAYOUT

6

al contempo il  
FACILITY MANAGER  
POTRÀ VERIFICARE QUALI SPAZI SONO  
STATI PRENOTATI e  
REALMENTE OCCUPATI



1 - Access the P4Y APP from your PC, TABLET OR SMARTPHONE to quickly and REMOTELY BOOK the DESK or MEETING ROOM you want to use.

À partir d'un ORDINATEUR, D'UNE TABLETTE OU D'UN SMARTPHONE, en accédant à l'APPLI P4Y vous pouvez RÉSERVER RAPIDEMENT À DISTANCE le BUREAU ou la SALLE DE RÉUNION que vous voulez utiliser.

4 - THE P4Y APP can be INTEGRATED with OFFICE 365 and GSUITE. This allows you to manage your BOOKINGS DIRECTLY from your SHARED CORPORATE CALENDAR.

L'APPLI P4Y est INTÉGRABLE avec OFFICE 365 et G SUITE. Cela vous permet de gérer les RÉSERVATIONS DIRECTEMENT depuis le CALENDRIER D'ENTREPRISE PARTAGÉ.

2 - DESKS and MEETING ROOMS ARE EQUIPPED WITH A QR CODE positioned on the DESKTOP or VISIBLE ON THE MEETING ROOM TABLET SCREEN.

Les BUREAUX et les SALLES DE RÉUNION SONT MUNIS DE QR CODE positionné sur le PLATEAU DU BUREAU ou VISIBLE SUR L'ÉCRAN DE LA TABLETTE DE LA SALLE DE RÉUNION.

5 - The P4Y APP is DESIGNED TO CHECK OCCUPANCY OF SPACES in real time BY DISPLAYING THE ENTIRE LAYOUT.

L'APPLI P4Y est CONÇUE POUR VÉRIFIER - en temps réel - L'OCCUPATION DES ESPACES À TRAVERS L'AFFICHAGE DE TOUTE LA DISPOSITION.

3 - USING THE P4Y APP, BY SCANNING THE QR CODE you can CHECK IN - if you have booked remotely - or proceed directly to the booking.

AVEC L'APPLI P4Y, EN ENCADRANT LE QR CODE, vous pourrez effectuer le CHECK IN - si vous avez réservé à distance - ou procéder directement à la réservation.

6 - At the same time, THE FACILITY MANAGER WILL BE ABLE TO CHECK WHICH SPACES HAVE BEEN BOOKED and ACTUALLY OCCUPIED.

Parallèlement, le FACILITY MANAGER POURRA VÉRIFIER QUELS ESPACES ONT ÉTÉ RÉSERVÉS ET SONT RÉELLEMENT OCCUPÉS.

Place4You

Scopri di più sull'app P4Y



Discover more about the P4Y app

En savoir plus sur l'appli P4Y

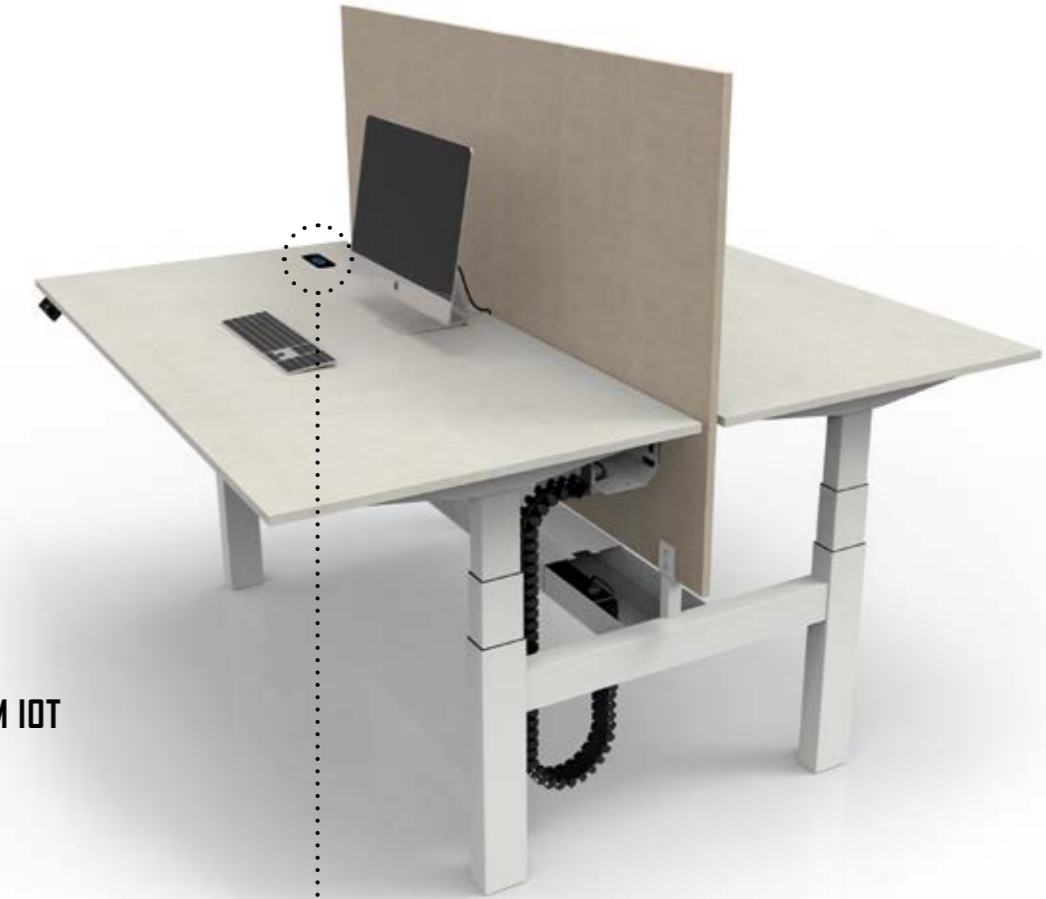

I VANTAGGI che porta con sé un PROGETTO IVM IOT  
The ADVANTAGES of an IVM IOT PROJECT  
Les AVANTAGES du PROJET IVM IOT

### PRENOTAZIONE SEMPLICE e RAPIDA

di postazioni operative o di meeting room tramite APP P4Y \_ da PC, TABLET E SMARTPHONE sia con sistema ANDROID che IOS.

QUICK and EASY BOOKING of workstations or meeting rooms via P4Y APP \_ from PCs, TABLETS AND SMARTPHONES with both ANDROID and iOS systems.

RÉSERVATION SIMPLE et RAPIDE de postes de travail ou de salles de réunion par le biais de l'APPLI P4Y \_ installée sur un ORDINATEUR, UNE TABLETTE ET UN SMARTPHONE, compatible avec les systèmes d'exploitation ANDROID et iOS.

### OTTIMIZZAZIONE DELLO SPAZIO

Riducendo il numero delle stazioni di lavoro fisse, è possibile sfruttare al meglio lo spazio disponibile, riducendo i costi di gestione del building.

OPTIMISING THE SPACE

By reducing the number of fixed workstations, you can make the best use of the available space, thereby reducing building management costs.

OPTIMISATION DE L'ESPACE

La réduction du nombre de postes de travail fixes permet de tirer parti au mieux de l'espace disponible, en réduisant des frais de gestion du bâtiment.

### ANALISI UTENTI E GESTIONE DEI DATI RACCOLTI

Rapporti dettagliati e completi aiutano a prendere decisioni di pianificazione migliori perché consentono di monitorare l'utilizzo degli spazi di lavoro.

REVIEWING USER BREAKDOWN AND MANAGING COLLECTED DATA

Detailed and comprehensive reports help you make better planning decisions because they allow you to monitor the use of the workspaces.

ANALYSE DE L'UTILISATION et GESTION DES DONNÉES COLLECTÉES

Des rapports détaillés et complets qui améliorent la prise de décision en termes de planification puisqu'ils contrôlent l'utilisation des espaces de travail.



22	STILO
80	TABULA
134	LUCERNA SISTEMA DI ILLUMINAZIONE
148	T.REGOLO
166	FUNNY SAT
188	I_BENCH
210	SISTEMI INTEGRATI
	212 SISTEMA PONTE
	232 ARKO
	244 KOSMOS
	256 KS.LIGHT
	280 CANALIZZAZIONE COMPLEMENTI
	288 LE FINITURE
300	LOCKERS & CONTENITORI

# SISTEMI OPERATIVI

PER L'ARREDO INTELLIGENTE

# STILO

DESIGN by PERIN&PARTNERS

STILO traccia il profilo del nuovo ufficio, fra idee per l'innovazione, proposte per lo smart office e una profonda rivoluzione culturale. Un approccio multidisciplinare finalizzato a ottenere il meglio dall'integrazione di tecnologie ed elementi di arredo.

Perché l'ufficio è vivo, vitale, in trasformazione.

STILO charts the profile of the new office, based on ideas for innovation, proposals for a smart office and a sweeping cultural revolution. A multidisciplinary approach aimed at making the most of integrated technologies and furniture.

Because the office is alive, buzzing and progressive.

STILO esquisse le profil du nouveau bureau en proposant des idées en matière d'innovation et de « smart office », alliées à une véritable révolution culturelle. Une approche multidisciplinaire visant à tirer le meilleur de l'intégration entre technologies et éléments de mobilier.

Parce que le bureau est un espace vital, vivant, en pleine mutation.



## NEW FINISHES

**PIANI**  
TOP  
PLATEAUX

**GRAFITE**  
GRAPHITE  
**CANAPA**  
WARM GREY\_CHANVRE  
**VISONE**  
MOSS GREY\_VISON  
**OTTANIO**  
PETROL GREEN\_VERT PÉTROLE

**STILO WOOD**  
**GAMBE**  
LEGS\_PIEDS

**ROVERE**  
**VERNICIATO NATURALE**  
NATURAL VARNISHED OAK  
CHÊNE VERNIS NATUREL



STILO

A staged platform of solutions  
that turn the workplace  
into a **"NICE PLACE TO BE"**.

Une palette de solutions  
qui transforment le lieu de travail  
en un endroit **AGRÉABLE**.

ivm introduces **STiLO**

Un palcoscenico di soluzioni  
che trasformano il luogo di lavoro  
in un **"NICE PLACE TO BE"**.





NICE PLACE TO BE

THE PROJECT HEART

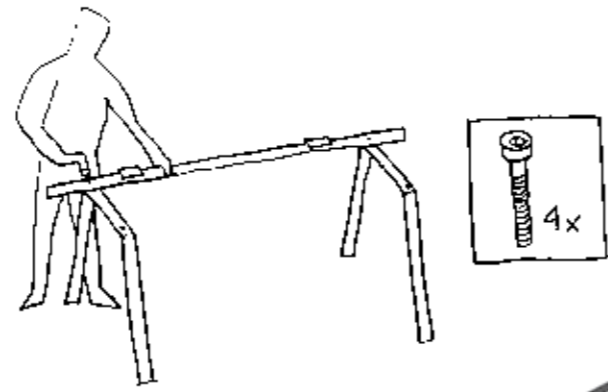

QUICK FIX

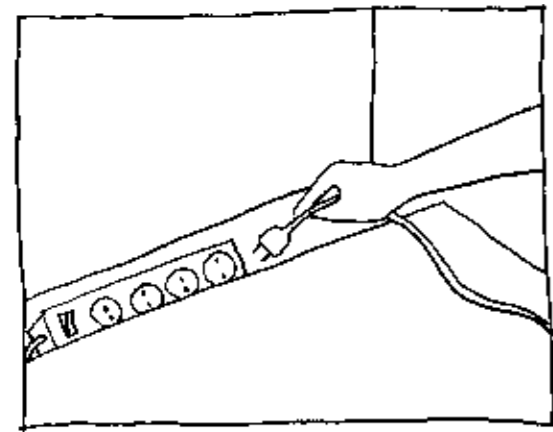
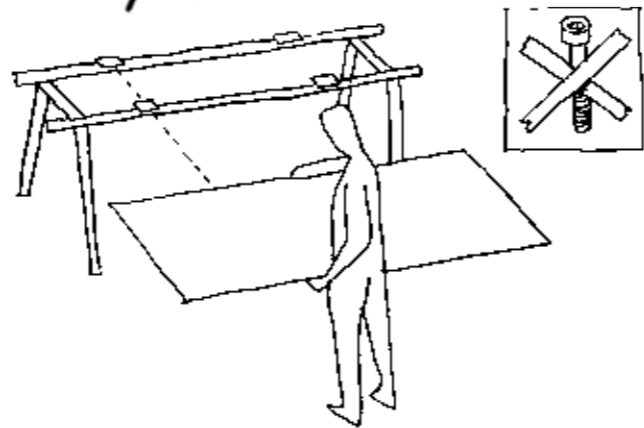

HEIGHT ADJUSTABLE TABLE

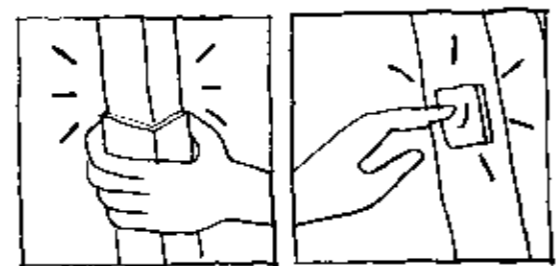
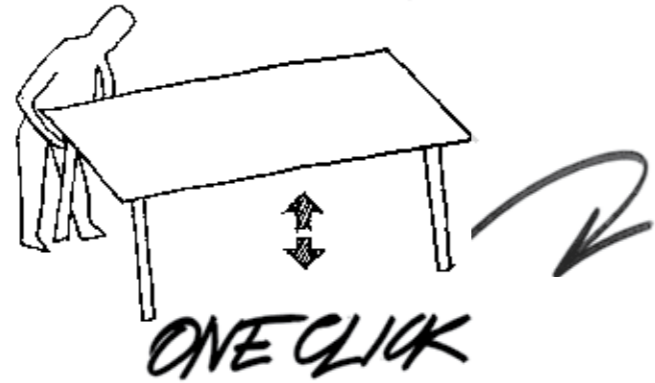

PRIVACY

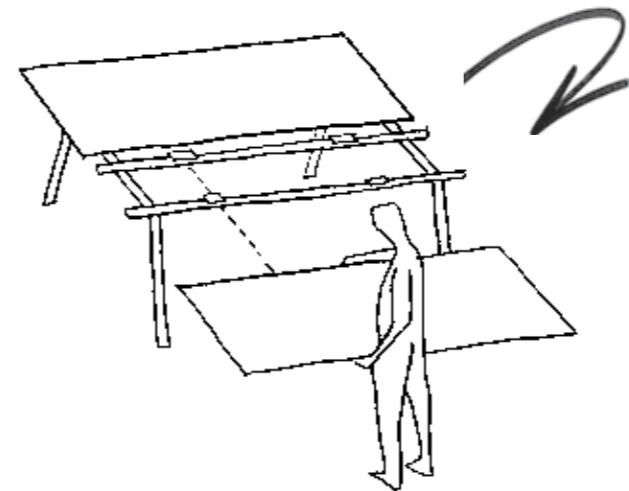
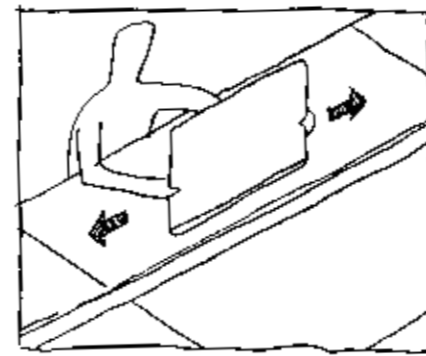

PSYCHOLOGICAL IMPACT  
CIRCADIAN RHYTHM



HUMAN CENTRIC LIGHTING

CREATES HARMONY WITH THE WORKING ENVIRONMENT

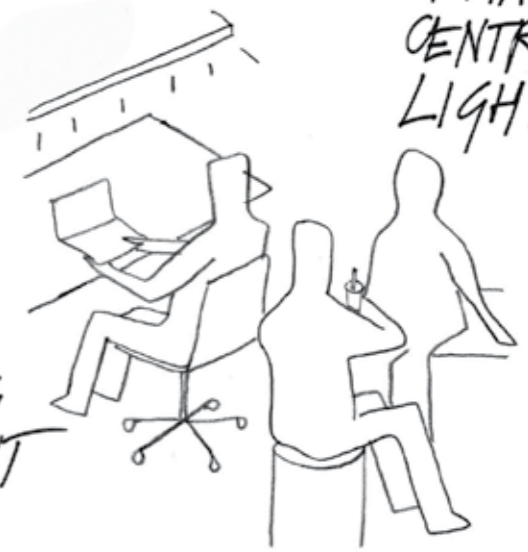

THE PROJECT HEART

# THE PROJECT HEART

La STRUTTURA viene assemblata comodamente e in rapidità dall'alto - in piedi - con 4 viti. Il PIANO viene montato con la tecnologia **QUICK FIX** senza l'utilizzo di ferramenta e attrezzi.

The FRAMEWORK is quick and easy to assemble from a standing position - with just four screws. The TOP is attached using **QUICK FIX** technology without the need for hardware and tools.

La STRUCTURE est assemblée facilement et rapidement par le haut, debout, à l'aide de 4 vis. Le PLATEAU est monté grâce à la technologie **QUICK FIX** sans l'emploi de quincaillerie ni d'outils.

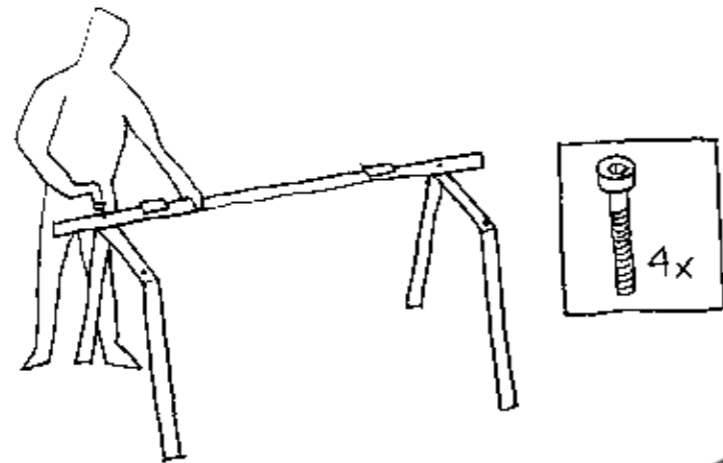

## QUICK FIX

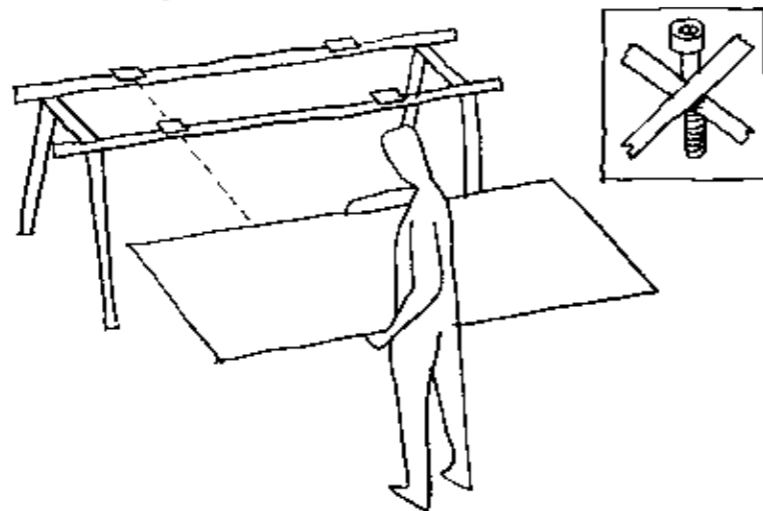





Flessibilità  
Multidisciplinarietà  
Interazione



# THE PROJECT HEART

Il PIANO di lavoro è predisposto per lo scorrimento **SLIDING TOP** facilitando così l'accesso alle prese senza l'installazione di botole passacavi.

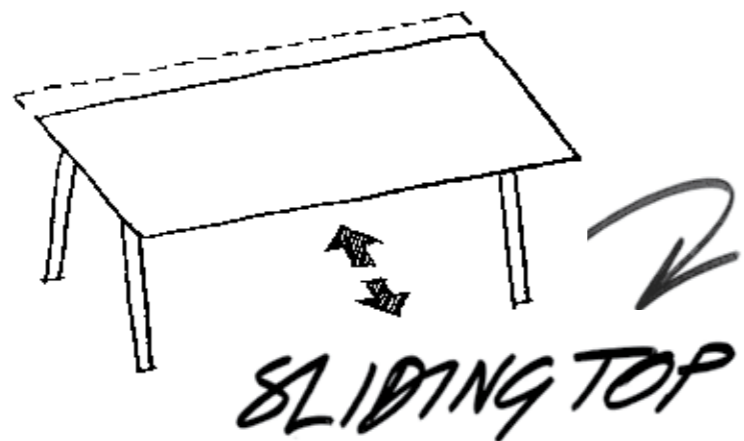

The **SLIDING TOP** makes it easy to access power and data without installing desk grommets.

Le plan de travail est disponible dans la version coulissante (**SLIDING**), ce qui facilite l'accès à la connectique sans l'installation de passe-câbles ronds.

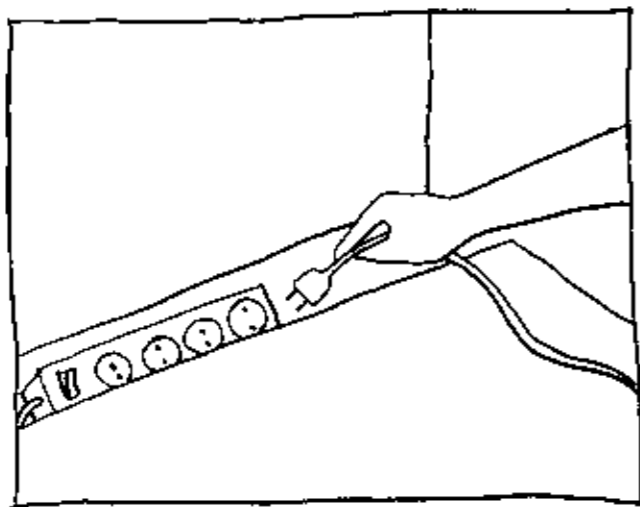

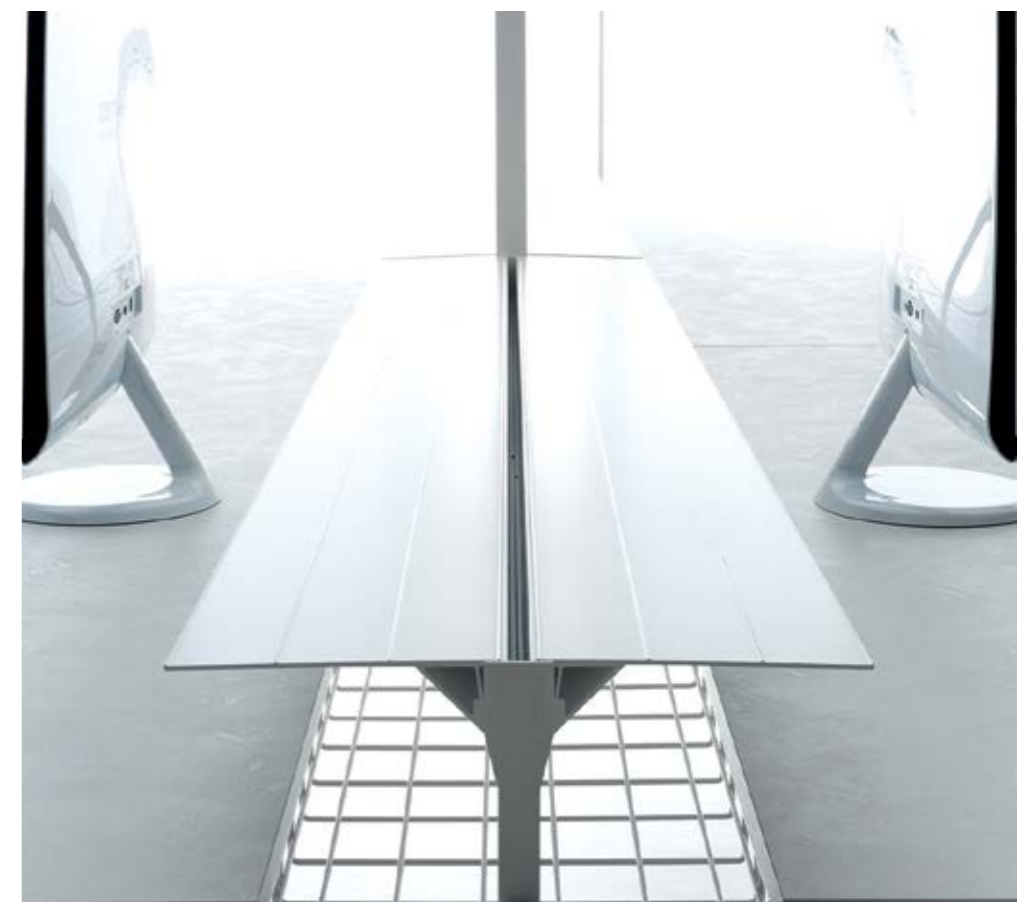
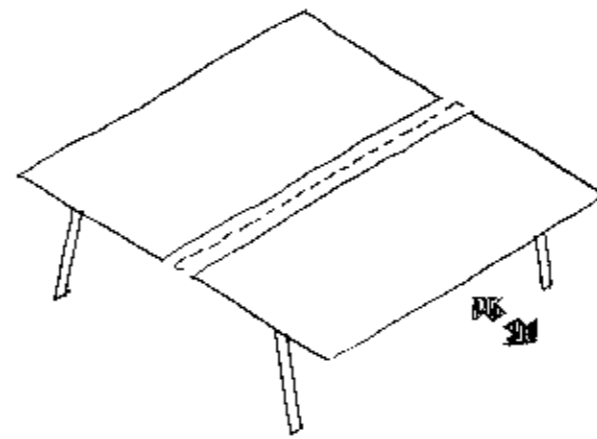
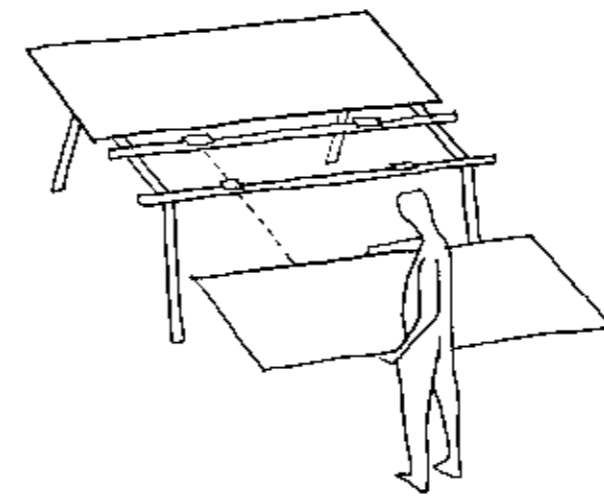

STILO mantiene tutte le peculiarità del sistema QUICKFIX anche con i piani SLIDING.

STILO retains all the features of the QUICKFIX system even with the SLIDING tops.

STILO préserve toutes les particularités du système QUICKFIX, même en présence de plateaux coulissants SLIDING.

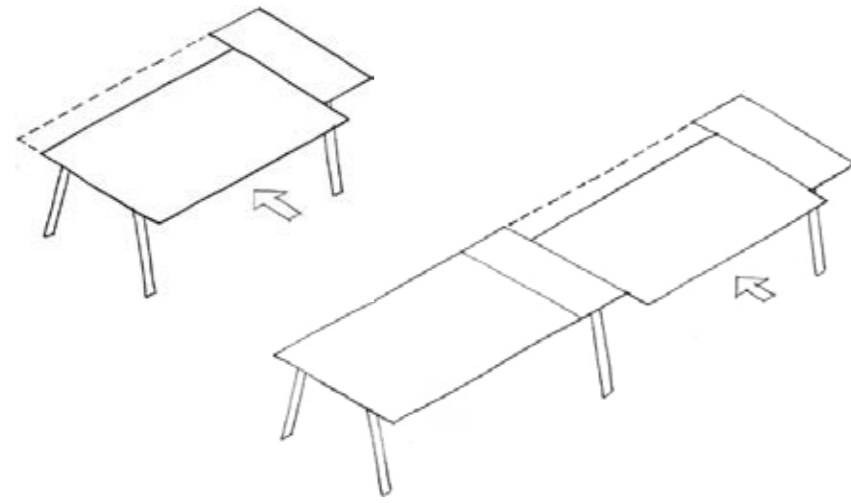

Si può avere una scrivania con un piano scorrevole e uno fisso su un'unica struttura... anche con più postazioni in linea.

You can have a desk with one sliding top and one fixed top all on the same framework... as well as with a number of side-by-side workstations.

Vous pouvez disposer d'un bureau doté d'un plateau coulissant et d'un autre fixe sur une seule structure... même en présence de plusieurs postes de travail en rangée.



## Flessibilità di sistema

Il sistema SLIDING funziona anche con postazioni in linea con gamba condivisa.

The SLIDING system also functions with side-by-side workstations that share legs.

Le système SLIDING fonctionne également avec des postes de travail en rangée avec piètement partagé.

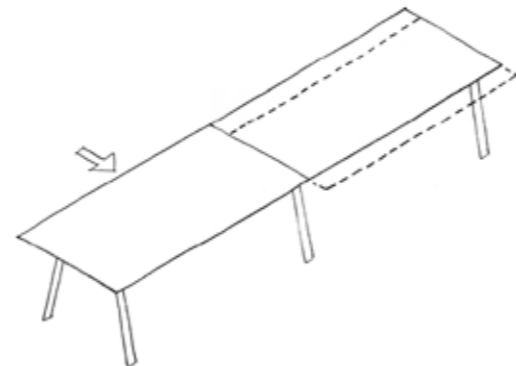

# THE PROJECT HEART

La regolazione in altezza della scrivania è fondamentale per la salute della persona. Il particolare sistema a scatti ONE CLICK permette di determinare l'altezza del piano in modo autonomo tra i 65 cm e gli 85 cm.

A height-adjustable desk is essential to the health of people. The special ONE CLICK system makes it possible to independently set the height of the worktop at between 65 cm and 85 cm.

Le réglage en hauteur du bureau est fondamental pour la santé. Le système particulier à crans ONE CLICK permet de régler individuellement la hauteur du plateau entre 65 cm et 85 cm.

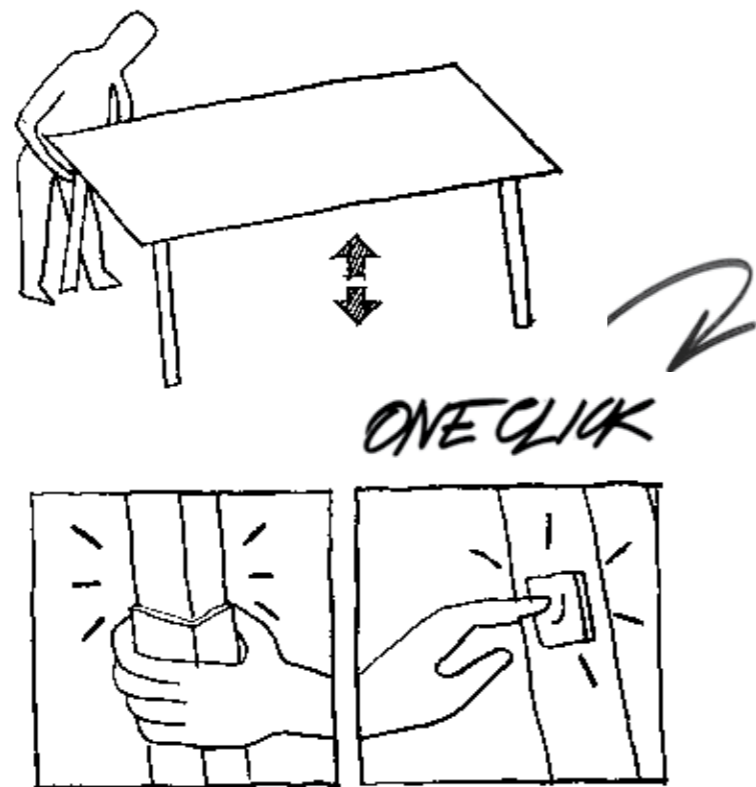



SCRIVANIE  
REGOLABILI IN  
ALTEZZA

# ONE CLICK H 65\_85



HEIGHT  
ADJUSTABLE  
TABLE

BUREAUX  
RÉGLABLES EN  
HAUTEUR

# THE PROJECT HEART

La struttura permette di ottenere superfici di grandi dimensioni, ideali per configurazioni BENCHING. Il "concetto" di PRIVACY è risolto con alloggiamento di screen sia frontali, che laterali. Gli screen laterali sono disponibili con morsetti di ancoraggio al piano oppure con basamento.

The framework can be set up to obtain large surface areas, perfect for BENCHING SYSTEMS. The concept of PRIVACY is solved by inserting front and side screens. Side screens can be fixed to the top using clamps, or they can be supplied with their own base.

La structure permet d'obtenir des surfaces de grandes dimensions, idéales pour bureaux BENCH (partagés). Le « concept » de CONFIDENTIALITÉ est préservé grâce à des écrans privatifs frontaux et latéraux. Les écrans latéraux peuvent être équipés de pinces de fixation au plateau ou d'un socle.

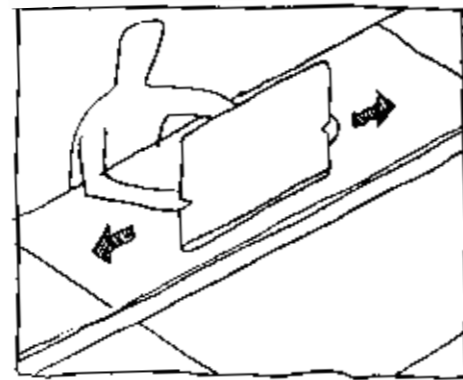
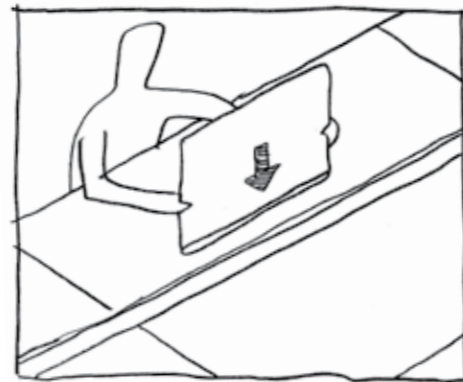

PRIVACY





**NEW**  
**STiLO**  
**WOOD**



THE  
PROJECT  
HEART



Flessibilità di progetto



I COMPLEMENTI  
ELEMENTI PENSILI



ELEMENTO A 1 CASSETTO  
ONE-DRAWER UNIT  
ELEMENT A 1 TIROIR

ELEMENTO A 1 CASSETTO+VANO  
ONE-DRAWER UNIT + COMPARTMENT  
ELEMENT A 1 TIROIR + NICHE



ELEMENTO A 2 CASSETTI  
TWO-DRAWER UNIT  
ELEMENT A 2 TIROIRS

ELEMENTO A 2 CASSETTI+VANO  
TWO-DRAWER UNIT + COMPARTMENT  
ELEMENT A 2 TIROIRS + NICHE





A staged platform  
of solutions that turn  
the workplace into a  
"NICE PLACE TO BE"



La struttura permette di ottenere superfici di grandi dimensioni, ideali per configurazioni workstation, hoteling e conferencing.

The framework can be set up to obtain large surface areas, perfect for workstation, hoteling and conference configurations.

La structure permet d'obtenir des surfaces de grandes dimensions, idéales pour les configurations de postes de travail, bureaux flexibles et tables de réunion

## LA TECNOLOGIA



VASSOIO ACCUMULO CAVI  
IN FILO DI METALLO  
per scrivanie doppie

WIRE CABLE BASKET  
for double desks

CHEMIN DE CÂBLES  
EN FIL MÉTALLIQUE  
pour bureaux doubles

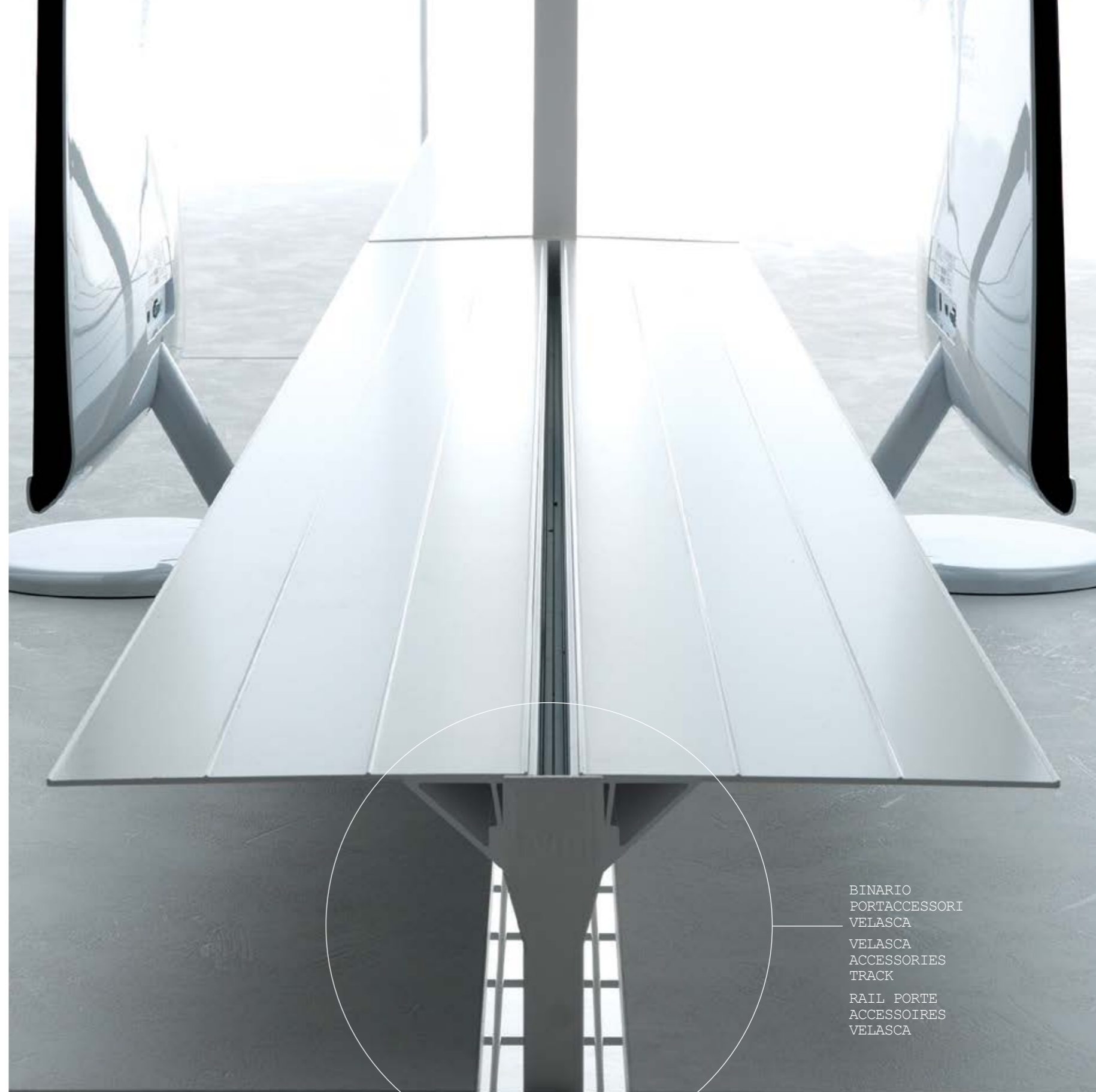

BINARIO  
PORTACCESSORI  
VELASCA  
VELASCA  
ACCESSORIES  
TRACK  
RAIL PORTE  
ACCESSOIRES  
VELASCA



VERTEBRA PER PASSAGGIO CAVI  
modello STANDARD  
in policarbonato trasparente

CABLE MANAGEMENT VERTEBRAE  
STANDARD model  
transparent polycarbonate

VERTÈBRE PASSE-CABLE  
modèle STANDARD  
polycarbonate transparent



VASSOIO ACCUMULO CAVI  
IN LAMIERA PRESSOPIEGATA  
per scrivanie singole

SHEET STEEL CABLE  
MANAGEMENT TRAY  
for single desks

CHEMIN DE CÂBLES  
EN TÔLE PLIÉE  
pour bureaux simples



MULTIPRESA  
"CUSTOM"  
Completa di STAFFA di AGGAN-  
CIO per PIANI

MULTI-SOCKET  
MULTIPRISE  
"CUSTOM"



MULTIPRESA  
"BASE"  
Completa di STAFFA  
di AGGAN-  
CIO per PIANI

MULTI-SOCKET  
MULTIPRISE  
"BASE"



MULTIPRESA  
"COMBI"

MULTI-SOCKET  
MULTIPRISE  
"COMBI"



LIVELLI DI ATTREZZABILITÀ DEI PIANI

PIANO FIXED PIANO SLIDING



FIXED TOP  
PLATEAU FIXED



SLIDING TOP  
PLATEAU SLIDING



Le scrivanie SINGOLE e DOPPIE del sistema STILO possono essere completate dal BINARIO PORTACCESSORI VELASCA.

The SINGLE and DOUBLE desks of the STILO system can be completed with the VELASCA ACCESSORIES TRACK.

Les bureaux SIMPLES OU DOUBLES du système STILO peuvent être complétés par le RAIL PORTE-ACCESSOIRES VELASCA.

BINARIO VELASCA



VELASCA TRACK  
RAIL VELASCA

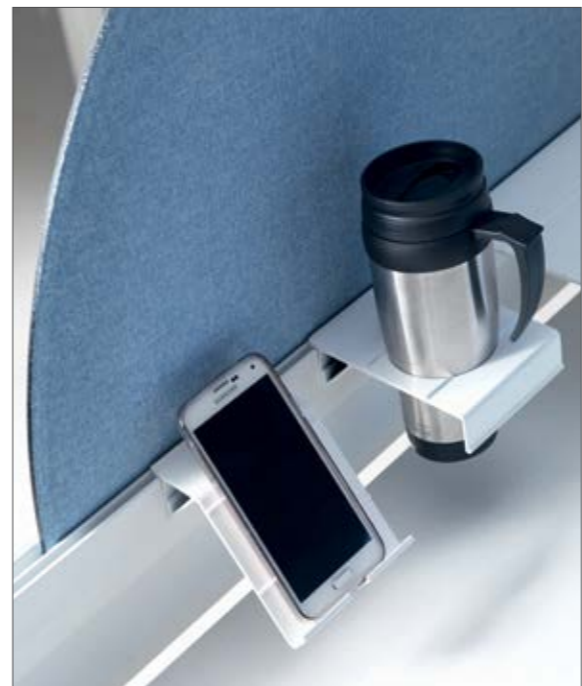

ACCESSORI VELASCA

ACCESSORI #STILO

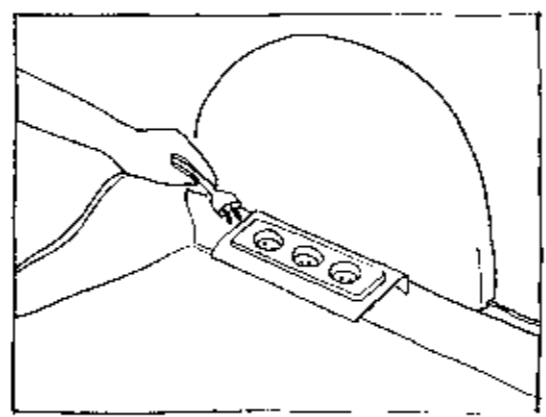

PORTAMONITOR



PORTA CPU



MODELLO A "CINGHIA"



MODELLO "BIG"



PORTA CPU SOSPESO adattabile alle diverse dimensioni del cpu stesso. Particolarmente efficace nella sua semplicità il sistema di "fissaggio" del CPU.

SUSPENDED CPU HOLDER  
Can be adapted to the actual size of the cpu. The CPU "locking" system is as effective as it is simple.

SUPPORT UC SUSPENDU  
Adaptable aux différentes dimensions de l'unité centrale. La simplicité du système de fixation de l'UC est particulièrement efficace.



FINITURE<sup>dei</sup> PIANI  
TOP FINISHES  
FINITIONS<sup>DES</sup> PLATEAUX

Per una corretta valutazione di tonalità e colore delle diverse finiture rappresentate a catalogo, è necessario fare riferimento ai campioni fisici.

Due to variances in printed colours, see the swatches for the actual colours and shades of the different finishes.

Pour une évaluation correcte du ton et de la couleur des différentes finitions représentées dans le catalogue, il est nécessaire de se référer aux échantillons physiques.

ANTARCITE

BIANCO RAL9016

ROVERE VERNICIATO NATURALE

Le GAMBE



LEGS  
LE PIÈTEMENT

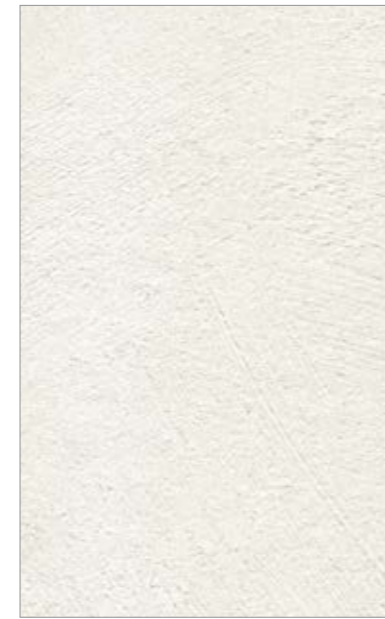

SPATOLATO CEMENTO  
CEMENT RENDER EFFECT / BÉTON TALOCHÉ



AVORIO  
IVORY / IVOIRE



GRAFITE  
GRAPHITE

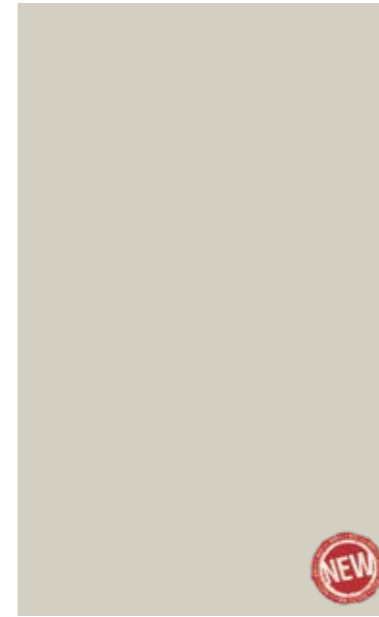

CANAPA  
WARM GREY / CHANVRE



VISONE  
MOSS GREY / VISON



OTTANIO  
PETROL GREEN / VERT PÉTROLE



VULCANO



OLMO PANNA  
ELM CREAM / ORME CRÈME



OLMO TESTA DI MORO  
ELM DARK BROWN / ORME FONCÉ



NOCE  
WALNUT / NOYER

NOBILITATO  
LAMINATE  
MELAMINÉ

LE FINITURE DEI PIANI SONO LIBERAMENTE ACCOSTABILI ALLE FINITURE PREVISTE PER LE GAMBE.

MATCH THE TOP FINISH WITH THE FINISH SELECTED FOR THE LEGS.

LES FINITIONS DES PLATEAUX SONT COMBINABLES AVEC LES FINITIONS PRÉVUES POUR LE PIÈTEMENT.

FINITURE <sup>degli</sup> SCREEN  
 SCREEN FINISHES  
 FINITIONS <sup>des</sup> ÉCRANS



ARANCIO  
ORANGE

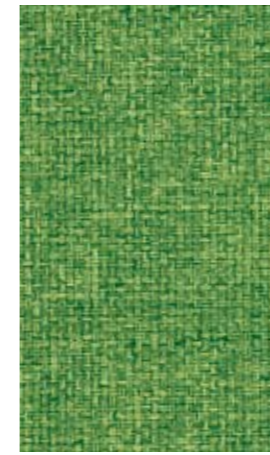

VERDE  
GREEN / VERT



AZZURRO  
BLUE / BLEU



SABBIA  
SAND / SABLE

**TESSUTO  
FONOASSORBENTE**

SOUND ABSORBING  
FABRIC

TISSU ACOUSTIQUE



GRAFITE  
GRAPHITE



CANAPA  
WARM GREY / CHANVRE



VISONE  
MOSS GREY / VISON



OTTANIO  
PETROL GREEN / VERT PÉTROLE

**NOBILITATO**

LAMINATE  
MELAMINÉ

LE FINITURE DEGLI SCREEN  
SONO LIBERAMENTE ACCOSTABILI  
ALLE FINITURE PREVISTE  
PER I PIANI.

MATCH THE SCREEN  
FINISH WITH THE FINISH  
SELECTED FOR THE TOPS.

LES FINITIONS DES ÉCRANS SONT  
COMBINABLES AVEC LES FINITIONS  
PRÉVUES POUR LE PLATEAUX.



NOCE  
WALNUT / NOYER



VULCANO



FELTRO  
FELT / FEUTRE



AVORIO  
IVORY / IVOIRE



SPATOLATO CEMENTO  
CEMENT RENDER EFFECT / BÉTON TALOCHÉ



OLMO PANNA  
ELM CREAM / ORME CRÈME



OLMO TESTA DI MORO  
ELM DARK BROWN / ORME FONCÉ



PENELOPE SABBIA  
PENELOPE SAND/SABLE



PENELOPE ARGILLA  
PENELOPE CLAY/ARGILE



ALLUMINIO  
ALUMINIUM

**CRISTALLO  
ACIDATO**

ETCHED GLASS  
VERRE ACIDÉ



SCRIVANIE LINEARI P80

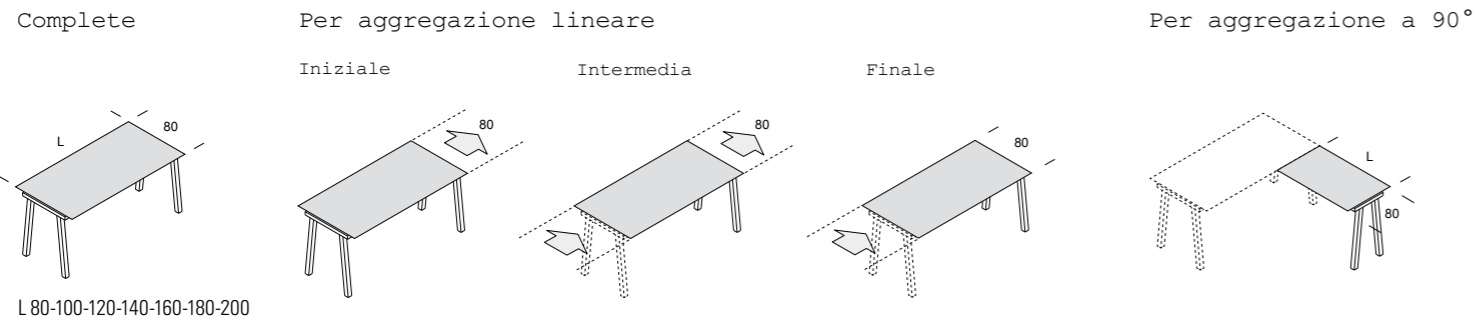

SCRIVANIE LINEARI P60

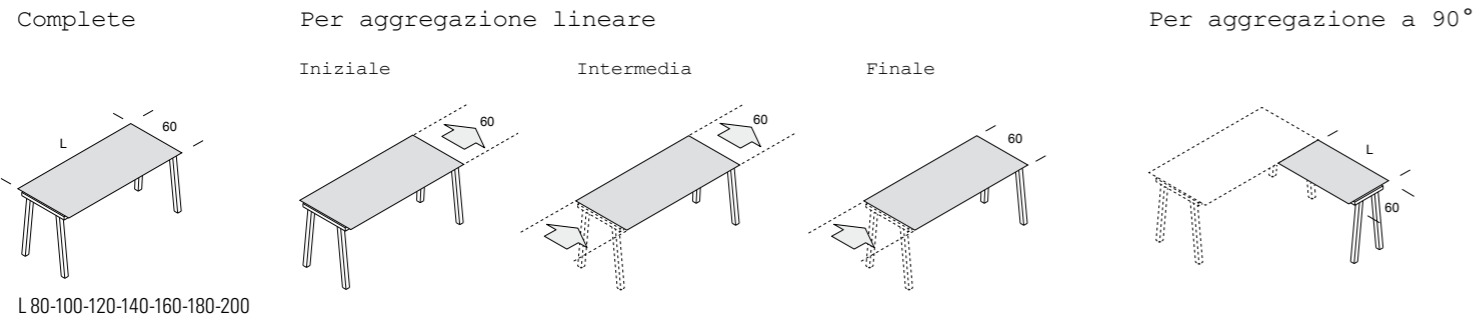

SCRIVANIE DOPPIE P165

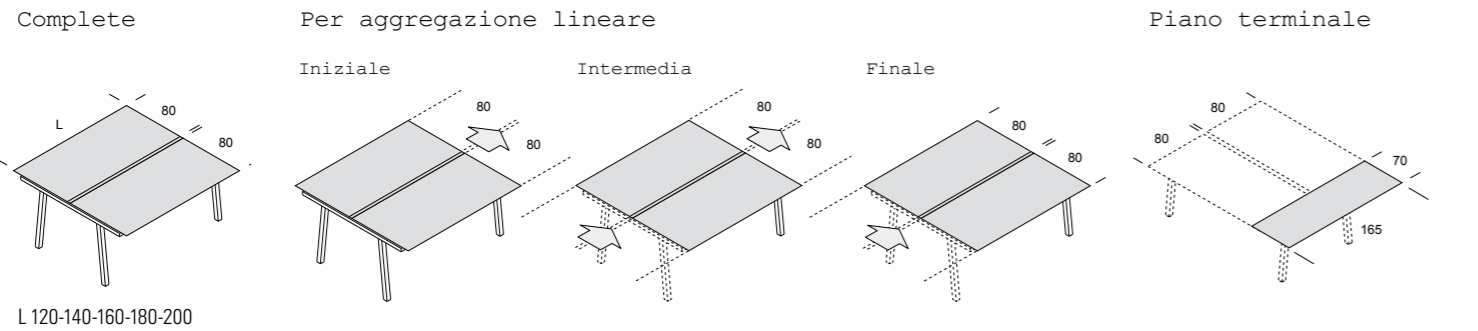

SCRIVANIE DOPPIE P125

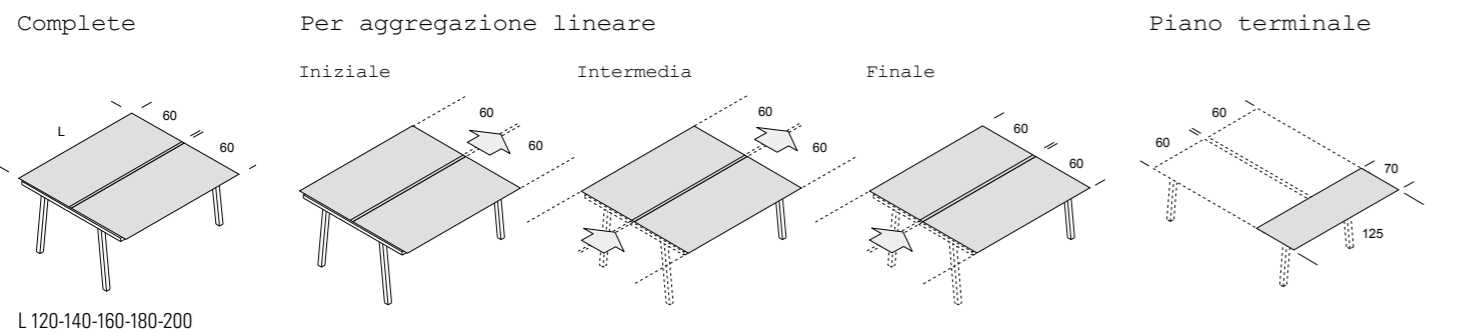

TAVOLI RIUNIONE

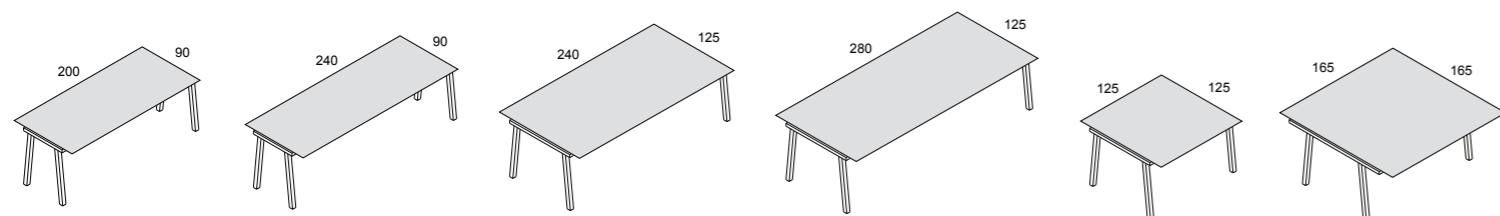

LAMPADE LUCERNA



SCREEN FRONTALI

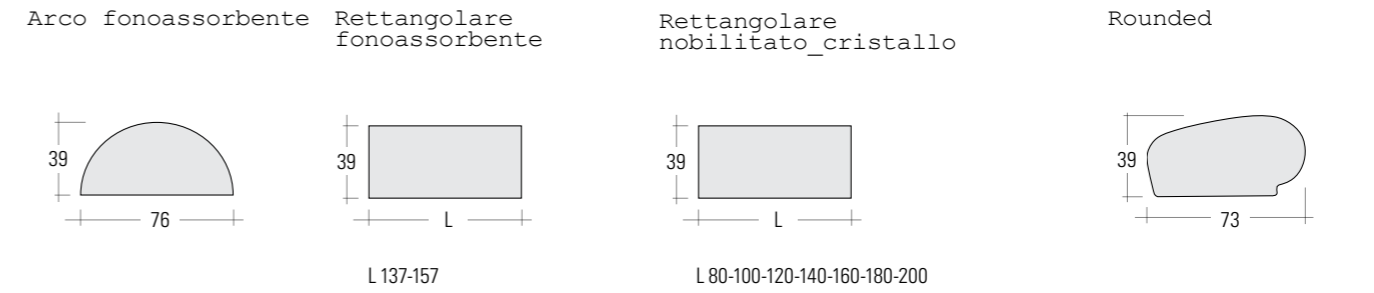

SCREEN LATERALE

MODESTY PANEL



BINARIO VELASCA



MENSOLA

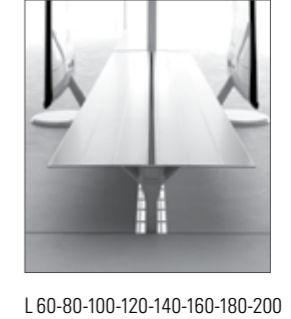

ELEMENTI PENSILI

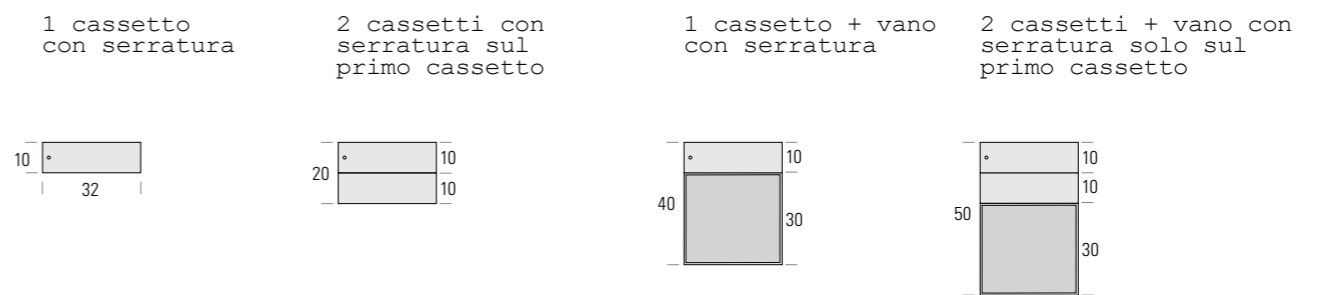

CANALIZZAZIONE



## STILO \_SPECIFICHE TECNICHE

### SCRIVANIE, TAVOLI RIUNIONE, ALLUNGHI LATERALI composti da:

#### PIANI LAVORO in NOBILITATO

Piani lavoro realizzati in conglomerato ligneo sp.18 mm, con densità di circa 650 Kg/m³, nobilitati su entrambi i lati mediante l'utilizzo di carte melaminiche a grammatura 120 gr/mq e con finitura superficiale antigraffio ed antiriflesso, nelle finiture **Avorio, Spatolato Cemento, Olmo (Testa di Moro, Panna), Noce Canaletto, Vulcano, Grafite, Canapa, Visone e Ottanio**. I pannelli presentano una buona resistenza a flessione e trazione, ottima resistenza all'invecchiamento e alle macchie. I bordi perimetrali sono costituiti da una miscela in ABS, incollati con colla poliuretanica ed arrotondati. La reazione al fuoco dei pannelli utilizzati di serie è compresa nella classe seconda.

Ogni piano viene fornito con **tecnologia QUICK FIX** (sistema che permette il posizionamento dei piani senza l'utilizzo di ferramenta) **già montata** ed \_in base alla richiesta del cliente\_ è dotato di sistema di aggancio **FIXED** o di sistema di aggancio scorrevole **SLIDING TOP**. Entrambi i sistemi sono composti da n°4 slitte e n°2 maniglie realizzate in Nylon6 FV15% in colore Alluminio.

#### GAMBE METALLICHE FISSE (Tipo C Rif. Normativa EN 527-1:2011)

Gambe metalliche a cavalletto, previste in 5 tipologie dimensionali \_prof. 60, 80, 90, 125 e 165 cm\_ composte da un traverso orizzontale in tubolare metallico a sezione rettangolare 60x40x sp. 2 mm e da due montanti verticali inclinati realizzati in tubolare metallico sezione quadrata 50x50x sp. 2 mm, entrambi collegati al traverso tramite un tubolare metallico a sezione tonda diam. 35 x sp. 2 mm che li distanzia di 10 mm. Verniciate con polveri epossidiche nei colori, Bianco opaco Ral 9016 e Antracite Micalizzato, oppure in Rovere Verniciato Naturale per la variante STILO WOOD. Sul traverso orizzontale sono premontate due o quattro selle (due per le gambe prof. 60, 80 e 90 e quattro per le gambe P.125 e 165) in Nylon6 FV20% nei colori Bianco o Antracite con funzioni di aggancio trasversi.

Le gambe sono corredate di tappi e puntali entrambi realizzati in ABS stampato nei colori Bianco o Antracite. I puntali sono dotati di piedini regolabili con escursione di 20 mm (per un perfetto livellamento al pavimento). Le gambe intermedie si ottengono mediante l'applicazione, durante le fasi di montaggio, di un particolare costampato in metallo e Nylon6 FV20% in color Alluminio inserito nelle selle presenti sul traverso orizzontale.

#### GAMBE METALLICHE CON REGOLAZIONE IN ALTEZZA A DUE STADI\_ DA 65 A 85 CM\_ CON PULSANTE \_ nome commerciale "ONE CLICK"

(Tipo B Rif. Normativa EN 527-1:2011)

Gambe metalliche a forma di cavalletto, previste in 5 tipologie dimensionali prof. 60, 80, 90, 125 e 165 cm, composte da un traverso orizzontale in tubolare metallico a sezione rettangolare 60x40x sp. 2 mm e da due montanti interni verticali inclinati realizzati in tubolare metallico sezione quadrata 40x40x sp. 2 mm.

Su entrambi i montanti sono presenti sia le tacche che la scala di regolazione altezza passo 20 mm (ricavata tramite stampo di coniatura).

La regolazione è ottenuta grazie ad una seconda coppia di montanti verticali esterni inclinati in tubolare metallico sezione quadrata 50x50x sp. 2 mm sui quali è montato il pulsante a scatto\_ in Nylon6 FV20% nei colori Bianco o Antracite \_ che ne permette la regolazione in altezza da un minimo di 65 cm ad un massimo di 85 cm con intervalli di 2 cm. Tutte le tipologie di gambe sono verniciate con polveri epossidiche nei colori, Bianco opaco Ral 9016 e Antracite Micalizzato. Sul traverso orizzontale sono premontate due o quattro selle (due per le gambe P.60, 80 e 90 e quattro per le gambe P.125 e 165) in Nylon6 FV20% nei colori Bianco o Antracite con funzioni di aggancio trasversi. Le gambe sono corredate di tappi e puntali entrambi realizzati in ABS stampato nei colori Bianco o Antracite. I puntali sono dotati di piedini regolabili con escursione di 20 mm (per un perfetto livellamento al pavimento). Le gambe intermedie si ottengono mediante l'applicazione, durante le fasi di montaggio, di un particolare costampato in metallo e Nylon6 FV20% in color Alluminio inserito nelle selle presenti sul traverso orizzontale.

#### TRAVERSI STRUTTURALI

Sono realizzati in tubolare metallico a sezione rettangolare 25x40x sp. 2 mm verniciati con polveri epossidiche nei colori, Bianco Opaco Ral 9016 e Antracite Micalizzato. Su ogni traverso sono presenti una coppia di particolari slitte in Nylon6 FV20% nei colori Bianco o Antracite per l'aggancio dei piani dotati sia di sistema ad aggancio rapido fisso FIXED che di sistema ad aggancio rapido scorrevole SLIDING TOP.

Tutti i trasversi sono corredate nelle estremità di tappi terminali realizzati in ABS colore Bianco o Antracite asportabili in caso di utilizzo con gambe intermedie. I trasversi degli allunghi sono ottenuti utilizzando i medesimi trasversi delle scrivanie con l'aggiunta di un Kit di aggancio in Nylon6 FV20% nei colori Bianco o Antracite composto da due staffe più un distanziale regolabile per le profondità del piano p.60 e p.80 mm.

### PENISOLA (Utilizzabile solo con scrivanie Altezza FISSA) composta da:

#### ELEMENTI CONTENITORI

Scocca realizzata in conglomerato ligneo sp.18 mm, placcato da entrambi i lati in nobilitato resistente all'abrasione nei colori **Avorio o Penelope Argilla**. Ante, Frontali Cassetti e Schienali abbinati realizzati in conglomerato ligneo sp.18 mm, placcato da entrambi i lati in nobilitato resistente all'abrasione nelle finiture **Avorio, Spatolato Cemento, Olmo Testa di Moro, Olmo Panna, Noce Canaletto, Vulcano, Grafite, Canapa, Visone e Ottanio**. Serratura dotata di cilindro estraibile con chiave pieghevole antinfortunio in duplice copia e impugnatura coprichiave in ABS. Maniglia in Zama disponibile nei colori Bianco opaco Ral 9016 e Antracite Micalizzato. Cassetto con cassetti interni sp.12 mm, rivestiti in PVC penelope grigio. Guide metalliche Quadro (scorrevoli su sfere) a scomparsa con rientro soft. Serratura a chiusura simultanea di tutti i cassetti.

#### SET di FINITURA

Realizzato in conglomerato ligneo sp.18 mm, placcato da entrambi i lati in nobilitato resistente all'abrasione nei colori **Avorio, Spatolato Cemento, Olmo Testa di Moro, Olmo Panna, Noce Canaletto, Vulcano, Grafite, Canapa, Visone e Ottanio**. Base dotata di piedini regolabili colore nero.

#### SUPPORTO di COLLEGAMENTO MOBILE SCRIVANIE

Il supporto, disponibile per piani profondità 80, 90, 125 e 165 cm, è composto da un traverso orizzontale in tubolare metallico a sezione rettangolare 60x40x sp. 2 mm e da due distanziali realizzati in ABS stampato nei colori Bianco o Antracite. Tutte le tipologie di supporti sono verniciati e con polveri epossidiche nei colori, Bianco opaco Ral 9016 e Antracite Micalizzato. Sul traverso sono premontate due o quattro selle (due per le gambe P.80 e 90 e quattro per le gambe P.125 e 165) in Nylon6 FV20% nei colori Bianco o Antracite con funzioni di aggancio trasversi. I supporti sono corredate di tappi realizzati in ABS stampati nei colori Bianco o Antracite.

## STILO \_SPECIFICHE TECNICHE

### VELASCA

#### PROFILO VELASCA

Composto da un profilo estruso in lega di alluminio EN AW-6060 verniciato con polveri epossidiche nei colori Bianco opaco Ral 9016 e Antracite Micalizzato. Il profilo è agganciato alla struttura tramite due staffe in Nylon6 FV20% in color Bianco o Antracite. Il profilo è corredate di tappi realizzati in ABS stampati nei colori Bianco o Antracite.

#### SCREEN FRONTALI PER VELASCA disponibili nei seguenti materiali:

- **TESSUTO** nei colori Melange Arancio, Verde, Azzurro e Sabbia, con materassino fonoassorbente a densità variabile ottenuta attraverso la termoformatura del materiale con stampo in alluminio. Questa tecnica consente di ottenere un manufatto in grado di assorbire un più ampio spettro di lunghezze d'onda. I pannelli, inseriti nella velasca mediante due mollette in ABS, sono facilmente posizionabili. Disponibili nelle configurazioni a Semicerchio (L.76 x H.39 cm) e Rettangolare (77, 117, 137 e 157 x H.39 cm)
- **NOBILITATO** realizzati in conglomerato ligneo sp.18 mm, con densità di circa 650 Kg/m³, nobilitati su entrambi i lati mediante l'utilizzo di carte melaminiche a grammatura 120 gr/mq e con finitura superficiale antigraffio ed antiriflesso, nelle finiture **Avorio, Spatolato Cemento, Olmo Testa di Moro, Olmo Panna, Noce Canaletto, Feltr, Penelope Sabbia, Penelope Argilla, Vulcano, Grafite, Canapa, Visone e Ottanio**. I pannelli presentano una buona resistenza a flessione e trazione, ottima resistenza all'invecchiamento ad alle macchie. I bordi perimetrali sono costituiti da una miscela in ABS, incollati con colla poliuretanica ed arrotondati. La reazione al fuoco dei pannelli utilizzati di serie è compresa nella classe seconda. I pannelli, inseriti nella velasca mediante due mollette in ABS, sono facilmente posizionabili. Disponibili nella configurazione RETTANGOLARE.
- **CRISTALLO** realizzati in cristallo float Acidato sp.8 mm Temperato. I pannelli, inseriti nella velasca mediante due mollette in ABS, sono facilmente posizionabili. Disponibili nella configurazione RETTANGOLARE.

#### MENSOLA VELASCA

Composta da un profilo estruso in lega di alluminio EN AW-6060 verniciato con polveri epossidiche nei colori, Bianco opaco Ral 9016 e Antracite Micalizzato. Le mensole si agganciano liberamente alla Velasca e possono essere facilmente spostate e riposizionate.

#### ACCESSORI VELASCA

Composti da un profilo estruso in lega di alluminio EN AW-6060 verniciato con polveri epossidiche nei colori, Bianco opaco Ral 9016 e Antracite Micalizzato. Gli accessori si agganciano liberamente alla Velasca e possono essere facilmente spostate e riposizionate. Disponibili nelle seguenti funzioni:

- Porta matite L.10 x P.14 cm completo di porta matite in plastica Trasparente
- Porta tazza termica L.10 x P.14 cm completo di tazza termica
- Porta cellulare L.10 x P.14 cm
- Porta prese L.25 x P.14 cm completo di multipresa con 3 prese combinate Schuko-Italia

### COMPLEMENTI

#### SCREEN FRONTALI

Agganciati alla struttura mediante due staffe in Nylon6 FV20% in color Bianco o Antracite, dotate di due morsetti a pinza in Nylon6 FV20% in color Bianco o Antracite. Disponibili nei seguenti materiali:

- **TESSUTO** nei colori Melange Arancio, Verde, Azzurro e Sabbia, con materassino fonoassorbente a densità variabile ottenuta attraverso la termoformatura del materiale con stampo in alluminio. Questa tecnica consente di ottenere un manufatto in grado di assorbire un più ampio spettro di lunghezze d'onda. Disponibili nelle configurazioni a Semicerchio (L.76 x H.39 cm) e Rettangolare (77, 117, 137 e 157 x H.39 cm).
- **NOBILITATO** realizzati in conglomerato ligneo sp.18 mm, con densità di circa 650 Kg/m³, nobilitati su entrambi i lati mediante l'utilizzo di carte melaminiche a grammatura 120 gr/mq e con finitura superficiale antigraffio ed antiriflesso, nelle finiture **Avorio, Spatolato Cemento, Olmo Testa di Moro, Olmo Panna, Noce Canaletto, Feltr, Penelope Sabbia, Penelope Argilla, Vulcano, Grafite, Canapa, Visone e Ottanio**. I pannelli presentano una buona resistenza a flessione e trazione, ottima resistenza all'invecchiamento ad alle macchie. I bordi perimetrali sono costituiti da una miscela in ABS, incollati con colla poliuretanica ed arrotondati. La reazione al fuoco dei pannelli utilizzati di serie è compresa nella classe seconda. Disponibili nella configurazione RETTANGOLARE.
- **CRISTALLO** realizzati in cristallo float Acidato sp.8 mm Temperato. Disponibili nella configurazione RETTANGOLARE.

#### SCREEN LATERALE disponibile nei seguenti materiali:

- **TESSUTO** nei colori Melange Arancio, Verde, Azzurro e Sabbia, con materassino fonoassorbente a densità variabile ottenuta attraverso la termoformatura del materiale con stampo in alluminio. Questa tecnica consente di ottenere un manufatto in grado di assorbire un più ampio spettro di lunghezze d'onda. Disponibili nelle configurazioni SAGOMATO L.73 x H.39 cm.
- **NOBILITATO** realizzati in conglomerato ligneo sp.18 mm, con densità di circa 650 Kg/m³, nobilitati su entrambi i lati mediante l'utilizzo di carte melaminiche a grammatura 120 gr/mq e con finitura superficiale antigraffio ed antiriflesso, nelle finiture **Avorio, Spatolato Cemento, Olmo Testa di Moro, Olmo Panna, Noce Canaletto, Feltr, Penelope Sabbia, Penelope Argilla, Vulcano, Grafite, Canapa, Visone e Ottanio**. I pannelli presentano una buona resistenza a flessione e trazione, ottima resistenza all'invecchiamento ad alle macchie. I bordi perimetrali sono costituiti da una miscela in ABS, incollati con colla poliuretanica ed arrotondati. La reazione al fuoco dei pannelli utilizzati di serie è compresa nella classe seconda. Disponibili nella configurazione SAGOMATO L.73 x H.39 cm.

Gli screen laterali possono essere agganciati alla piano mediante un Kit composto da una staffa di appoggio e da un morsetto metallico disponibili nei colori Bianco Ral 9016 o Antracite Micalizzato oppure appoggiati al piano mediante l'utilizzo di una piastra in metallo disponibile nei colori Bianco Ral 9016 o Antracite Micalizzato. Quest'ultima opzione rende lo screen laterale liberamente posizionabile.

#### ELEMENTI PENSILI IN METALLO

Realizzati in lamiera piegata e saldata 8/10, verniciati con polveri epossidiche nei colori Bianco opaco Ral 9016 oppure Antracite Micalizzato. Cassetti interni in Metallo completi di guide Quadro (scorrevoli su sfere) a scomparsa con rientro soft. Serratura disponibile di serie sul primo cassetto, dotata di cilindro estraibile con chiave pieghevole antinfortunio in duplice copia e impugnatura coprichiave in ABS. Maniglia laterale integrata nel frontale cassetto. Tutti gli elementi sono liberamente agganciabili alla struttura e facilmente spostabili grazie all'utilizzo di 4 clip in Nylon6 FV20% in color Bianco o Antracite montate sul top dell'elemento tramite una coppia di staffe metalliche che ne agevolano il posizionamento. Gli elementi sono disponibili nelle seguenti configurazioni:

- Un cassetto con serratura \_ L.32 x P.50 x **H.10 cm**
- Due cassetti (primo cassetto dotato di serratura) \_ L.32 x P.50 x **H.20 cm**
- Un cassetto con serratura + vano \_ L.32 x P.50 x **H.40 cm**
- Due cassetti (primo cassetto dotato di serratura) + vano \_ L.32 x P.50 x **H.40 cm**

P.S.: dimensioni Vano L.32 x P.50 x H.30 cm

#### MODESTY PANEL

Realizzati in conglomerato ligneo sp.18 mm, con densità di circa 650 Kg/m³, nobilitati su entrambi i lati mediante l'utilizzo di carte melaminiche a grammatura 120 gr/mq e con finitura superficiale antigraffio ed antiriflesso, nelle finiture **Avorio, Vulcano, Spatolato Cemento, Olmo Testa di Moro, Olmo Panna, Noce Canaletto, Vulcano, Grafite, Canapa, Visone e Ottanio**. I pannelli presentano una buona resistenza a flessione e trazione, ottima resistenza all'invecchiamento ad alle macchie. I bordi perimetrali sono costituiti da una miscela in ABS, incollati con colla poliuretanica ed arrotondati.

## STILO \_SPECIFICHE TECNICHE

La reazione al fuoco dei pannelli utilizzati di serie è compresa nella classe seconda.  
I pannelli sono agganciati alla struttura tramite una coppia di staffe metalliche sp.3 mm verniciate con polveri epossidiche nei colori, Bianco opaco Ral 9016 e Antracite Micalizzato su ogni staffa è applicata una clip in Nylon6 FV20% in color Bianco o Antracite.

### BRACCIO PORTA MONITOR

Realizzato in pressofusione di alluminio verniciato nei colori Bianco o Nero, con sistema di bilanciamento monitor a cinghia che permette l'applicazione di monitor da 0 a 9 kg. Regolazione bilanciamento tramite rotella, senza l'utilizzo di nessun utensile. Rotazione a 360° con possibilità di bloccarne la rotazione a 180° (+90°/-90°). Piastra per aggancio monitor a clip, rotazione 360° ed attacco VESA 75 & 100.

### PORTA CPU SOSPESO

- **Modello BIG** Realizzato in lamiera piegata verniciata con polveri epossidiche nel colore Bianco opaco Ral 9016. Possibilità di regolazione in Altezza da 37,7 a 53,2 cm e in Larghezza da 7,8 a 22 cm. Peso massimo CPU 15 Kg.  
- **Modello A CINGHIA** composto da un meccanismo tenditore completo di cinghia in Nylon colore nero. Sopra al tenditore è montata una piastra metallica che inserita in una seconda piastra sagomata ne permette lo scorrimento e la rotazione. Entrambe le piastre sono verniciate con polveri epossidiche nel colore Alluminio Ral 9006. Possibilità di regolazione in Altezza da 24 a 50 cm e in Larghezza da 8 a 22,5 cm. Peso massimo CPU 15Kg.  
Tutti i porta CPU sono liberamente agganciabili alla struttura e facilmente spostabili grazie all'utilizzo di 4 clip in Nylon6 FV20% in color Bianco o Antracite montate tramite una coppia di staffe metalliche che ne agevolano il posizionamento.

## CANALIZZAZIONE

### VASCONE per accumulo CAVI per SCRIVANIE DOPPIE

Realizzato in Ferrofilo diam. 4 mm verniciato con polveri epossidiche nei colori, Bianco opaco Ral 9016 e Antracite Micalizzato. L'aggancio alla struttura avviene mediante l'utilizzo di 4 clip in Nylon6 FV20% in color Bianco o Antracite montate su appositi sostegni presenti sul vascone. Disponibili nelle seguenti DIMENSIONI/tipologie:

- Per piani intermedi L.60 e 80 cm
- Per scrivanie L.140 cm
- Per scrivanie L.160 cm
- Per scrivanie L.180 e 200 cm

### VASCONE per accumulo CAVI per SCRIVANIE SINGOLE

Realizzato in lamiera piegata verniciata con polveri epossidiche nei colori, Bianco opaco Ral 9016 e Antracite Micalizzato. Dotato di tappi di chiusura laterale in Nylon6 FV10% in color Bianco o Antracite, con integrate clip fermacavi. I tappi sono agganciati a cerniere realizzate in Nylon6 FV10% in color Bianco o Antracite che ne permettono il fissaggio alla struttura e la rotazione. Disponibili nelle seguenti DIMENSIONI:

- Per scrivanie L.80, 100, 120, 140, 160, 180 e 200 cm

### VERTEBRA per PASSAGGIO CAVI STANDARD

Realizzata in Policarbonato trasparente lunghezza totale 81 cm. Base diam.16,5 cm realizzata in metallo verniciato color Alluminio.

### VERTEBRA per PASSAGGIO CAVI PLUS

Passacavi verticale a spirale realizzato in Metallo e setole in Nylon colore nero. Base ed aggancio realizzati in zama finitura Cromo Lucido.

### TOP ACCESS

Realizzati in Alluminio, con plastiche di chiusura laterale in ABS, sono disponibili in finitura Verniciato Bianco o Brill. L'apertura del coperchio è disponibile nella versione Frontale con integrato sistema di chiusura Soft oppure nella versione DOPPIA (apertura da entrambi i lati) grazie a particolari cerniere in policarbonato. Per il supporto delle multiprese possono essere utilizzate apposite vaschette portacavi (optional) oppure i vasconi per accumulo cavi (per scrivanie doppie e singole). Disponibili nelle seguenti misure: L.26,4 o 45,4 x P.12,5.

**Tutti i materiali utilizzati sono conformi alle norme UNI EN e sono certificati per il 90% CARB 2 (relativamente all'emissione di formaldeide).**

## STILO \_TECHNICAL SPECIFICATIONS

**DESKS, MEETING TABLES, DESK RETURNS** formed of:

### LAMINATE TOPS

Tops made from 18 mm-thick particleboard, with a density of about 650 kg/m<sup>3</sup>, covered on both sides by a layer of melamine-coated paper (120 g/m<sup>2</sup>), with a scratch-proof and anti-reflective surface, in the following finishes: **Ivory, Cement Render Effect, Dark Brown Elm, Cream Elm, Black Walnut, Vulcano, Graphite, Warm Grey, Moss Grey and Petrol Green.**  
The panels have high bending and tensile strength, and excellent resistance to ageing and stains. The edges are made from an ABS compound, fixed with polyurethane glue and rounded. The standard panels used are classified for reaction to fire in Class 2.

Each top is supplied with **QUICK FIX technology** (system that allows for positioning the tops without using hardware and tools) **already mounted** and - on the basis of the client's requirements - it is fitted with the **FIXED** or **SLIDING TOP** attachment system. Both systems are formed of four (4) slides and two (2) handles made from Nylon 6 +15% GF (Aluminium colour).

### FIXED METAL LEGS (Type C Reference Standard EN 527-1:2011)

Metal trestle legs, in five sizes (depth: 60, 80, 90, 125 and 165 cm), composed of a horizontal crosspiece in rectangular tubular steel (60x40xD.2 mm) and two angled vertical uprights in square tubular steel (50x50xD.2 mm), both connected to the crosspiece by a round tubular steel piece (35xD.2 mm), which separates them by 10 mm. Available in epoxy powder-coated finishes of Ral 9016 matte White and Anthracite Mica or in Natural Varnished Oak for the STILO WOOD variant. The crosspiece comes with two or four pre-mounted housing seats (two for the 60, 80 and 90 deep legs and four for the 125 and 165 deep legs) in Nylon 6 + 20% GF (colours: White or Anthracite) to fix the crosspieces in place. The legs are fitted with caps and tips, both made from moulded ABS (colours: White or Anthracite). The tips come with adjustable levellers with a range of 20 mm (for perfect levelling on floor). The middle legs are obtained during assembly by applying a special metal and Nylon 6 + 20% GF co-mould (Aluminium colour), inserted into the housing seats on the crossbeam.

### METAL LEGS WITH TWO-STEP HEIGHT ADJUSTMENT (65 - 85 CM) - WITH BUTTON (trade name "ONE CLICK")

#### (Type B Reference Standard EN 527-1:2011)

Metal trestle legs, in five sizes (depth: 60, 80, 90, 125 and 165 cm), composed of a horizontal crosspiece in rectangular tubular steel (60x40xD.2 mm) and two angled vertical uprights in square tubular steel (40x40xD.2 mm). Both the steps and the height adjustment scale with 20-mm pitch (obtained by embossing moulding) are mounted on each of the two uprights. Adjustment is obtained by means of a second pair of external angled vertical uprights in square tubular steel (50x50xD.2 mm) where the single-step button, made from Nylon 6 + 20% GF (colours: White or Anthracite) is mounted, allowing for height adjustment from a minimum of 65 cm to a maximum of 85 cm at 2 cm steps. All leg types are available in epoxy powder-coated finishes of Ral 9016 matte White and Anthracite Mica. The crosspiece comes with two or four pre-mounted housing seats (two for the 60, 80 and 90 deep legs and four for the 125 and 165 deep legs) in Nylon 6 + 20% GF (colours: White or Anthracite) to fix the crosspieces in place. The legs are fitted with caps and tips, both made from moulded ABS (colours: White or Anthracite). The tips come with adjustable levellers with a range of 20 mm (for perfect levelling on floor). The middle legs are obtained during assembly by applying a special metal and Nylon 6 + 20% GF co-mould (Aluminium colour), inserted into the housing seats on the crossbeam.

### STRUCTURAL CROSSPIECES

These are made from rectangular tubular steel (25x40xD.2 mm), available in epoxy powder-coated finishes of Ral 9016 matte White and Anthracite Mica. Each crosspiece is fitted with a pair of special slides made from Nylon 6 + 20% GF (colours: White or Anthracite) for coupling tops fitted with both the quick-fix "FIXED" system and the quick-fix "SLIDING TOP" system. The ends of all the crosspieces come with ABS end caps (colours: White or Anthracite), removable if middle legs are used. The extension crosspieces are obtained using the same crosspieces as the desks, with the addition of a coupling kit made from Nylon 6 + 20% GF (colours: White or Anthracite), composed of two brackets and an adjustable spacer for the depths of the top (60 mm and 80 mm).

**STRUCTURAL RETURN (Can only be used with FIXED height desks)** formed of:

### STORAGE UNITS

Shell made from 18 mm-thick particleboard, coated on both sides in scratch-proof laminate (colours: **Ivory** or **Penelope Clay**). Matching Door, Drawer Fronts and Backs made from 18 mm-thick particleboard, coated on both sides in scratch-proof laminate, with the following finishes: Ivory, Cement Render Effect, Dark Brown Elm, Cream Elm, Black Walnut, Vulcano, Graphite, Warm Grey, Moss Grey and Petrol Green. Complete with lock that has a removable barrel and duplicate keys with folding ABS safety key cover grip. Zamak handle available in Ral 9016 matte White and Anthracite Mica colours. Drawer unit fitted with 12 mm high inner drawers, coated in PVC ( in Penelope grey). Concealed Quadro metal runners (ball slides) with soft closing mechanism. Simultaneous locking of all drawers.

### FINISH SET

Made from 18 mm-thick particleboard, coated on both sides in scratch-proof laminate, with the following colours: Ivory, Cement Render Effect, Dark Brown Elm, Cream Elm, Black Walnut, Vulcano, Graphite, Warm Grey, Moss Grey and Petrol Green. Base fitted with black adjustable levellers.

### CONNECTION BRACKET FOR DESKS

The bracket is available for 80, 90, 125 and 165 cm deep tops, and is composed of a horizontal crosspiece in rectangular tubular steel (60x40xD.2 mm) and two spacers made from moulded ABS (colours: White or Anthracite). All bracket types are available in epoxy powder-coated finishes of Ral 9016 matte White and Anthracite Mica. The crosspiece comes with two or four pre-mounted housing seats (two for the 80 and 90 cm deep legs and four for the 125 and 165 cm deep legs) in Nylon 6 + 20% GF (colours: White or Anthracite) to fix the crosspieces in place. The brackets are fitted with caps made from moulded ABS (colours: White or Anthracite).

## STILO \_TECHNICAL SPECIFICATIONS

### VELASCA

#### VELASCA PROFILE

Composed of extruded profile in aluminium alloy (EN AW-6060), with epoxy powder-coated finishes of Ral 9016 matte White and Anthracite Mica. The profile is coupled to the structure by means of two brackets made from Nylon 6 + 20% GF (colours: White or Anthracite). The Profile is fitted with caps made from moulded ABS (colours: White or Anthracite).

**FRONT SCREENS FOR VELASCA** available in the following materials:

- **FABRIC** (colours: Orange Melange, Green, Sky Blue and Sand, with variable density sound-absorbent mat obtained by thermoforming the material with aluminium mould. This technique makes it possible to obtain an item that can absorb a larger spectrum of wavelengths. The panels are inserted into the Velasca track by two ABS clips and are easy to position.

Available in Semi-circle (L.76 x H.39 cm) and Rectangle (77, 117, 137 and 157 x H.39 cm) configurations.

- **LAMINATE** made from 18 mm-thick particleboard, with a density of about 650 kg/m<sup>3</sup>, covered on both sides by a layer of melamine-coated paper (120 g/m<sup>2</sup>), with a scratch-proof and anti-reflective surface, in the following finishes: Ivory, Cement Render Effect, Dark Brown Elm, Cream Elm, Black Walnut, Felt, Penelope Sand, Penelope Sable, Vulcano, Graphite, Warm Grey, Moss Grey and Petrol Green.

The panels have high bending and tensile strength, and excellent resistance to ageing and stains.

The edges are made from an ABS compound, fixed with polyurethane glue and rounded.

The standard panels used are classified for reaction to fire in Class 2.

The panels are inserted into the Velasca track by two ABS clips and are easy to position. Available in the RECTANGLE configuration

- **GLASS** made from 8-mm thick etched and tempered float glass. The panels are inserted into the Velasca track by two ABS clips and are easy to position. Available in the RECTANGLE configuration.

#### VELASCA SHELF

Composed of extruded profile in aluminium alloy (EN AW-6060), with epoxy powder-coated finishes of Ral 9016 matte White and Anthracite Mica. The shelves can be freely attached to the Velasca track and are easy to move and reposition.

#### VELASCA ACCESSORIES

Composed of extruded profile in aluminium alloy (EN AW-6060), with epoxy powder-coated finishes of Ral 9016 matte White and Anthracite Mica. The accessories can be freely attached to the Velasca track and are easy to move and reposition.

Available as follows:

Pen holder mounting rack (L.10 x D.14 cm), complete with clear plastic pen holder

Thermal mug holder (L.10 x D.14 cm), complete with thermal mug

Mobile phone holder (L.10 x D.14 cm)

Power socket holder (L.25 x D.14 cm) complete with power strip with three combined Schuko-Italy sockets

### ACCESSORIES

#### FRONT SCREENS

Coupled to the structure by means of two brackets made from Nylon 6 + 20% GF (colours: White or Anthracite), complete with two clips made from Nylon 6 + 20% GF (colours: White or Anthracite).

Available in the following materials:

- **FABRIC** (colours: Orange Melange, Green, Sky Blue and Sand, with variable density sound-absorbent mat obtained by thermoforming the material with aluminium mould. This technique makes it possible to obtain an item that can absorb a larger spectrum of wavelengths.

Available in Semi-circle (L.76 x H.39 cm) and Rectangle (77, 117, 137 and 157 x H.39 cm) configurations.

- **LAMINATE** made from 18 mm-thick particleboard, with a density of about 650 kg/m<sup>3</sup>, covered on both sides by a layer of melamine-coated paper (120 g/m<sup>2</sup>), with a scratch-proof and anti-reflective surface, in the following finishes: Ivory, Cement Render Effect, Dark Brown Elm, Cream Elm, Black Walnut, Felt, Penelope Sand, Penelope Sable, Vulcano, Graphite, Warm Grey, Moss Grey and Petrol Green.

The panels have high bending and tensile strength, and excellent resistance to ageing and stains.

The edges are made from an ABS compound, fixed with polyurethane glue and rounded.

The standard panels used are classified for reaction to fire in Class 2.

Available in the RECTANGLE configuration

- **GLASS** made from 8-mm thick etched and tempered float glass. Available in the RECTANGLE configuration

#### SIDE SCREEN

available in the following materials:  
- **FABRIC** (colours: Orange Melange, Green, Sky Blue and Sand, with variable density sound-absorbent mat obtained by thermoforming the material with aluminium mould. This technique makes it possible to obtain an item that can absorb a larger spectrum of wavelengths.

Available in the SHAPED configuration (L.73 x H.39 cm)

- **LAMINATE** made from 18 mm-thick particleboard, with a density of about 650 kg/m<sup>3</sup>, covered on both sides by a layer of melamine-coated paper (120 g/m<sup>2</sup>), with a scratch-proof and anti-reflective surface, in the following finishes: Ivory, Cement Render Effect, Dark Brown Elm, Cream Elm, Black Walnut, Felt, Penelope Sand, Penelope Sable, Vulcano, Graphite, Warm Grey, Moss Grey and Petrol Green.

The panels have high bending and tensile strength, and excellent resistance to ageing and stains.

The edges are made from an ABS compound, fixed with polyurethane glue and rounded.

The standard panels used are classified for reaction to fire in Class 2.

Available in the SHAPED configuration (L.73 x H.39 cm).

The side screens can be attached to the top using a kit composed of a holding bracket and a metal clip (available colours: Ral 9016 matte White and Anthracite Mica) or by resting it on the top by means of a metal plate (available colours: Ral 9016 matte White and Anthracite Mica).

The second option means the side screen can be freely positioned.

#### METAL SUSPENDED STORAGE UNITS

Made from bent and welded sheet metal (8/10), available with epoxy powder-coated finishes of Ral 9016 matte White and Anthracite Mica. Inner Metal drawers mounted on concealed Quadro metal runners (ball slides) with soft closing mechanism. Lock supplied standard on top drawer, complete with removable barrel and duplicate keys with folding ABS safety key cover grip. Side handled integrated into drawer front.

All units can be attached to the structure and are easy to move thanks to four clips in Nylon 6 + 20% GF (colours: White or Anthracite) mounted on the top of the unit by a pair of metal brackets to facilitate positioning.

The units are available in the following configurations:

• Single drawer with lock - L.32 x D.50 x **H.10 cm**

• Two drawers (top drawer with lock) - L.32 x D.50 x **H.20 cm**

• Single drawer with lock + compartment - L.32 x D.50 x **H.40 cm**

• Two drawers (top drawer with lock) + compartment - L.32 x D.50 x **H.40 cm**

P.S.: Compartment size - L.32 x D.50 x H.30 cm

## STILO \_TECHNICAL SPECIFICATIONS

### MODESTY PANEL

Made from 18 mm-thick particleboard, with a density of about 650 kg/m<sup>3</sup>, covered on both sides by a layer of melamine-coated paper (120 g/m<sup>2</sup>), with a scratch-proof and anti-reflective surface, in the following finishes: Ivory, Vulcano, Cement Render Effect, Dark Brown Elm, Cream Elm, Black Walnut, Vulcano, Graphite, Warm Grey, Moss Grey and Petrol Green.

The panels have high bending and tensile strength, and excellent resistance to ageing and stains.

The edges are made from an ABS compound, fixed with polyurethane glue and rounded.

The standard panels used are classified for reaction to fire in Class 2.

The panels can be attached to the structure using a pair of metal brackets (3 mm thick), available in epoxy powder-coated finishes of Ral 9016 matte White and Anthracite Mica. A clip in Nylon 6 + 20% GF (colours: White or Anthracite) is mounted on each bracket.

### DESK MOUNT MONITOR ARM

Made from die-cast aluminium painted White or Black, with strap-on monitor balancing that supports monitors of 0 to 9 kg.

Wheel balance adjustment without the use of tools. 360° rotation lockable at 180° (+90°/-90°). Clip-on monitor attachment plate, 360° rotation and VESA mount 75 & 100.

### SUSPENDED CPU HOLDER

- **BIG model** Made from sheet metal, with epoxy powder-coated finish in Ral 9016 matte White. Height adjustment from 37.7 to 53.2 cm.

Width adjustment from 7.8 to 22 cm. Maximum CPU weight - 15 Kg.

- **STRAP-ON model** composed of a tensioning mechanism complete with black Nylon strap.

A metal plate is mounted above the tensioning mechanism. This is inserted into a second, shaped plate for sliding and rotation.

Both plates have an epoxy powder-coated finish in Ral 9006 Aluminium. Height adjustment from 24 to 50 cm. Width adjustment from 8 to 22.5 cm. Maximum CPU weight - 15 Kg.

All CPU holders can be attached to the structure and are easy to move thanks to four clips in Nylon 6 + 20% GF (colours: White or Anthracite) mounted by a pair of metal brackets to facilitate positioning.

### CABLE DUCTING

#### CABLE management TRAY for BACK TO BACK DESKS

Made from wire (diameter 4 mm) in epoxy powder-coated finishes of Ral 9016 matte White and Anthracite Mica.

Four clips in Nylon 6 + 20% GF (colours: White or Anthracite) mounted on the brackets of the tray are used for attachment to structure.

Available in the following SIZES/types:

- For middle tops: L.60 and 80 cm
- For desks: L.140 cm
- For desks: L.160 cm
- For desks: L.180 and 200 cm

#### CABLE management TRAY for SINGLE DESKS

Made from bent sheet metal in epoxy powder-coated finishes of Ral 9016 matte White and Anthracite Mica.

Fitted with end caps in Nylon 6 + 10% GF (colours: White or Anthracite), with integrated cable clips.

The caps are attached by hinges made from Nylon 6 + 10% GF (colours: White or Anthracite) so they can be fixed to the structure and can be rotated.

Available in the following SIZES:

- For desks: L.80, 100, 120, 140, 160, 180 and 200 cm

#### STANDARD VERTEBRAE for CABLE MANAGEMENT

Made from clear Polycarbonate with total length of 81 cm.

Diameter of base 16.5 cm, made from Aluminium coated metal.

#### PLUS VERTEBRAE for CABLE MANAGEMENT

Vertical spine cable management system made from Metal and Nylon bristles (black).

Base and attachment made from Zamak with Polished Chrome finish.

#### TOP ACCESS

Made from Aluminium, they come in White or Brill finish. The lid opening comes in the Front version, with integrated soft-closing mechanism, or in the DOUBLE version (can be opened from either side), thanks to special polycarbonate hinges.

The power strips can be stored in specific cable management trays (optional) or in the cable management trays (for back to back and single desks).

Available in the following sizes: L.26.4 or 45.4 x D.12.5.

All materials used comply with UNI EN standards, and 90% of its production is certified to CARB 2 (formaldehyde emissions).

## STILO \_SPÉCIFICATIONS TECHNIQUES

**BUREAUX, TABLES DE RÉUNION, EXTENSIONS LATÉRALES** composés de :

### PLANS DE TRAVAIL en MÉLAMINÉ

Plans de travail réalisés en bois aggloméré de 18 mm d'épaisseur, avec une densité d'environ 650 kg/m<sup>3</sup> ; revêtement en mélaminé sur les deux côtés (grammage papier : 120 g/m<sup>2</sup>) ; traitement anti-rayures et antireflet.  
Finitions disponibles : **Ivoire, Béton Taloché, Orme Foncé, Orme Crème, Noyer Noir, Vulcano, Graphite, Chanvre, Vison et Vert Pétrôle.**  
Les panneaux ont une bonne résistance à la flexion et à la traction et une excellente résistance au vieillissement et aux taches. Les chants sur le pourtour sont en ABS, collés avec de la colle polyuréthane et arrondis. Les panneaux de série sont classés en catégorie 2 pour ce qui concerne la réaction au feu.

Chaque plateau est muni de la **Technologie QUICK FIX** (système qui permet le positionnement des plateaux sans l'utilisation d'éléments de quincaillerie) déjà montée et - selon les exigences du client - est équipé du système d'accrochage **FIXED** ou du système d'accrochage coulissant **SLIDING TOP**.  
Les deux systèmes sont composés de 4 glissières et de 2 poignées réalisées en Nylon 6 renforcé fibre de verre (15 %) de couleur aluminium.

### PIEDS MÉTALLIQUES À HAUTEUR FIXE (Type C, Réf. Norme EN 527-1:2011)

Pieds tréteaux métalliques déclinés en 5 dimensions (prof. 60, 80, 90, 125 et 165 cm) composés d'une traverse horizontale en tube de métal de section rectangulaire 60x40xép.2 mm et de 2 montants verticaux inclinés réalisés en tube de métal de section carrée 50x50x ép.2 mm, tous deux reliés à la traverse à l'aide d'un tube de métal de section ronde diam. 35xép.2 mm qui les tient à 10 mm de distance.  
Tous les types de pieds sont peints avec des poudres époxy de couleur Blanc mat RAL9016 et Anthracite Micacé.  
La traverse horizontale compte deux ou quatre logements préinstallés (deux pour les pieds de prof. 60, 80 et 90 et quatre pour les pieds de prof. 125 et 165) en Nylon 6 renforcé fibre de verre (20 %) de couleur Blanc ou Anthracite servant pour l'accrochage aux traverses.  
Les pieds sont munis de bouchons et embouts réalisés en ABS moulé de couleur Blanc ou Anthracite.  
Les embouts sont munis de vérins réglables de 20 mm (pour une mise à niveau parfaite).  
Les pieds intermédiaires sont obtenus en appliquant, lors du montage, un élément co-moulé en métal et Nylon 6 renforcé fibre de verre (20 %) de couleur aluminium inséré dans les logements présents sur la traverse horizontale.

### PIEDS MÉTALLIQUES AVEC RÉGLAGE EN HAUTEUR À DEUX ÉTAGES, DE 65 À 85 CM, AVEC BOUTON - nom commercial « ONE CLICK » (Type B, Réf. Norme EN 527-1:2011).

Pieds tréteaux métalliques prévus en 5 dimensions (prof. 60, 80, 90, 125 et 165 cm), composés d'une traverse horizontale en métal tubulaire de section rectangulaire 60x40xép.2 mm et de deux montants internes verticaux inclinés en métal tubulaire de section carrée 40x40x ép.2 mm.  
Ces deux montants sont munis des crans et d'échelle de réglage de la hauteur avec pas de 20 mm (obtenue par embossage).  
Le réglage est obtenu par une deuxième paire de montants verticaux externes inclinés en métal tubulaire de section carrée 50x50xép.2 mm sur lequel est monté le bouton - en Nylon 6 renforcé fibre de verre (20 %) de couleur Blanc ou Anthracite - qui permet le réglage en hauteur par crans d'un minimum de 65 cm à un maximum de 85 cm par pas de 2 cm. Sont peints avec des poudres époxy de couleur Blanc mat RAL9016 et Anthracite Micacé ou en Chêne Blanchi Naturel pour la variante STILO WOOD. La traverse horizontale compte deux ou quatre logements préinstallés (deux pour les pieds de prof. 60, 80 et 90 et quatre pour les pieds de prof. 125 et 165) en Nylon 6 renforcé fibre de verre (20 %) de couleur Blanc ou Anthracite servant pour l'accrochage aux traverses. Les pieds sont munis de bouchons et embouts réalisés en ABS moulé de couleur Blanc ou Anthracite.  
Les embouts sont munis de vérins réglables de 20 mm (pour une mise à niveau parfaite). Les pieds intermédiaires sont obtenus en appliquant, lors du montage, un élément co-moulé en métal et Nylon 6 renforcé fibre de verre (20 %) de couleur aluminium inséré dans les logements présents sur la traverse horizontale.

### TRAVERSES STRUCTURELLES

Réalisées en métal tubulaire de section rectangulaire 25x40xép.2 mm peintes avec des poudres époxy de couleur Blanc Mat RAL9016 et Anthracite Micacé. Chaque traverse est munie d'une paire de glissières spéciales en Nylon 6 renforcé fibre de verre (20 %) de couleur Blanc ou Anthracite pour la fixation des plateaux munis de système d'accrochage rapide fixe « FIXED » ou de système d'accrochage rapide coulissant « SLIDING TOP ». Toutes les traverses sont munies de bouchons d'extrémité en ABS Blanc ou Anthracite amovibles en cas d'utilisation avec les pieds intermédiaires. Les traverses des extensions sont obtenues en utilisant les mêmes traverses des bureaux plus un Kif de fixation en Nylon 6 renforcé fibre de verre (20 %) de couleur Blanc ou Anthracite composé de deux brides plus une entretoise réglable pour les profondeurs du plateau de 60 et 80 mm.

**RETOUR PORTEUR (utilisable uniquement avec les bureaux à hauteur FIXE)** composée de :

### RANGEMENTS

Structure en bois aggloméré de 18 mm d'épaisseur ; revêtement en mélaminé sur les deux côtés résistant à l'abrasion dans les couleurs **Ivoire** ou **Penelope Argile**. Portes, façades des tiroirs et dos combinés réalisés en bois aggloméré de 18 mm d'épaisseur ; revêtement en mélaminé sur les deux côtés résistant à l'abrasion. Finitions disponibles : **Ivoire, Béton Taloché, Orme Foncé, Orme Crème, Noyer Noir, Vulcano, Graphite, Chanvre, Vison et Vert Pétrôle.**  
Serrure avec cylindre amovible et deux clés avec couvre-clé de protection pliant en ABS. Poignée en Zamak disponible dans les couleurs Blanc mat RAL9016 et Anthracite Micacé. Caisson à tiroirs internes de 12 mm d'épaisseur, avec revêtement en PVC, finition Penelope gris.  
Coulisses à billes métalliques Quadro invisibles à fermeture amortie. Verrouillage centralisé.

### SET de FINITION

Réalisé en bois aggloméré de 18 mm d'épaisseur ; revêtement en mélaminé sur les deux côtés résistant à l'abrasion dans les couleurs **Ivoire, Béton Taloché, Orme Foncé, Orme Crème, Chêne Blanchi, Noyer Noir, Vulcano, Graphite, Chanvre, Vison et Vert Pétrôle.**  
Socle avec vérins de réglage de couleur noir.

### SUPPORT de RACCORDEMENT POUR BUREAUX

Le support, disponible pour les plateaux de prof. 80, 90, 125 et 165 cm, se compose d'une traverse horizontale en métal tubulaire de section rectangulaire 60x40xép.2 mm et de deux entretoises en ABS moulé de couleur Blanc ou Anthracite. Tous les types de supports sont peints avec des poudres époxy de couleur Blanc mat RAL9016 et Anthracite Micacé. La traverse compte deux ou quatre logements préinstallés (deux pour les pieds de prof. 80 et 90 et quatre pour les pieds de prof. 125 et 165) en Nylon 6 renforcé fibre de verre (20 %) de couleur Blanc ou Anthracite servant pour l'accrochage aux traverses. Les supports sont fournis avec des bouchons en ABS moulé de couleur Blanc ou Anthracite.

## STILO \_SPÉCIFICATIONS TECHNIQUES

**VELASCA**

### PROFIL VELASCA

Composé d'un profil extrudé en alliage d'aluminium EN AW-6060 peint avec des poudres époxy de couleur Blanc mat RAL9016 et Anthracite Micacé. Le profil est fixé à la structure au moyen de deux brides en Nylon 6 renforcé fibre de verre (20 %) de couleur Blanc ou Anthracite.  
Le profil est équipé de bouchons en ABS moulé de couleur Blanc ou Anthracite.

**ÉCRANS PRIVATIFS FRONTAUX POUR VELASCA** disponibles dans les matériaux suivants :

- **TISSU** dans les couleurs Mélange Orange, Vert, Bleu et Sable, avec du matériau acoustique à densité variable obtenu par le thermoformage avec un moule en aluminium. Cette technique permet d'obtenir un produit capable d'absorber un plus large spectre de longueurs d'onde. Les panneaux se positionnent facilement dans le profil Velasca à l'aide de deux clips en ABS.  
Disponibles dans les versions Demi-cercle (L.76xH.39 cm) et Rectangulaire (77, 117, 137 et 157xH.39 cm)  
- **MÉLAMINÉ** ; réalisés en bois aggloméré de 18 mm d'épaisseur, avec une densité d'environ 650 kg/m<sup>3</sup> ; revêtement en mélaminé sur les deux côtés (grammage papier : 120 g/m<sup>2</sup>) ; traitement anti-rayures et antireflet. Finitions disponibles : **Ivoire, Béton Taloché, Orme Foncé, Orme Crème, Noyer Noir, Feutre , Penelope Clay, Penelope Argile, Vulcano, Graphite, Chanvre, Vison et Vert Pétrôle.**  
Les panneaux ont une bonne résistance à la flexion et à la traction et une excellente résistance au vieillissement et aux taches. Les chants sur le pourtour sont en ABS, collés avec de la colle polyuréthane et arrondis. Les panneaux de série sont classés en catégorie 2 pour ce qui concerne la réaction au feu. Les panneaux se positionnent facilement dans le profil Velasca à l'aide de deux clips en ABS. Disponibles dans la version RECTANGULAIRE.  
- **VERRE** ; réalisés en verre float acidé et trempé de 8 mm d'épaisseur.  
Les panneaux se positionnent facilement dans le profil Velasca à l'aide de deux clips en ABS. Disponibles dans la version RECTANGULAIRE.

### ÉTAGÈRE VELASCA

Composée d'un profil extrudé en alliage d'aluminium EN AW-6060 peint avec des poudres époxy de couleur Blanc mat RAL9016 et Anthracite Micacé. Les étagères se fixent librement au rail Velasca et sont faciles à déplacer et à repositionner.

### ACCESSOIRES VELASCA

Composés d'un profil extrudé en alliage d'aluminium EN AW-6060 peint avec des poudres époxy de couleur Blanc mat RAL9016 et Anthracite Micacé. Les accessoires se fixent librement au rail Velasca et sont faciles à déplacer et à repositionner.  
Les accessoires disponibles sont les suivants :  
Porte-crayons L.10xP.14 cm avec pot en plastique transparent  
Porte-tasse isotherme L.10xP.14 cm avec tasse isotherme  
Support pour téléphone portable L.10 xP.14 cm  
Support L.25xP.14 cm doté de bloc multiprise avec 3 prises combinées type Schuko/type L (Italie)

### ACCESSOIRES

#### ÉCRANS PRIVATIFS FRONTAUX

Fixés à la structure au moyen de deux brides en Nylon 6 renforcé fibre de verre (20 %) de couleur Blanc ou Anthracite, avec deux pinces en Nylon 6 renforcé fibre de verre (20 %) de couleur Blanc ou Anthracite.  
Disponibles dans les matériaux suivants :  
- **TISSU** dans les couleurs Mélange Orange, Vert, Bleu et Sable, avec du matériau acoustique à densité variable obtenu par le thermoformage avec un moule en aluminium. Cette technique permet d'obtenir un produit capable d'absorber un plus large spectre de longueurs d'onde. Disponibles dans les versions Demi-cercle (L.76xH.39 cm) et Rectangulaire (77, 117, 137 et 157xH.39 cm)  
- **MÉLAMINÉ** ; réalisés en bois aggloméré de 18 mm d'épaisseur, avec une densité d'environ 650 kg/m<sup>3</sup> ; revêtement en mélaminé sur les deux côtés (grammage papier : 120 g/m<sup>2</sup>) ; traitement anti-rayures et antireflet. Finitions disponibles : **Ivoire, Béton Taloché, Orme Foncé, Orme Crème, Noyer Noir, Feutre , Penelope Clay, Penelope Argile, Vulcano, Graphite, Chanvre, Vison et Vert Pétrôle.**  
Les panneaux ont une bonne résistance à la flexion et à la traction et une excellente résistance au vieillissement et aux taches. Les chants sur le pourtour sont en ABS, collés avec de la colle polyuréthane et arrondis.  
Les panneaux de série sont classés en catégorie 2 pour ce qui concerne la réaction au feu. Disponibles dans la version RECTANGULAIRE.  
- **VERRE** ; réalisés en verre float acidé et trempé de 8 mm d'épaisseur. Disponibles dans la version RECTANGULAIRE.

#### ÉCRAN PRIVATIF LATÉRAL disponibles dans les matériaux suivants

- **TISSU** dans les couleurs Mélange Orange, Vert, Bleu et Sable, avec du matériau acoustique à densité variable obtenu par le thermoformage avec un moule en aluminium. Cette technique permet d'obtenir un produit capable d'absorber un plus large spectre de longueurs d'onde.  
Disponible dans la version GALBÉ L.73xH.39 cm  
- **MÉLAMINÉ** ; réalisé en bois aggloméré de 18 mm d'épaisseur, avec une densité d'environ 650 kg/m<sup>3</sup> ; revêtement en mélaminé sur les deux côtés (grammage papier : 120 g/m<sup>2</sup>) ; traitement anti-rayures et antireflet. Finitions disponibles : **Ivoire, Béton Taloché, Orme Foncé, Orme Crème, Noyer Noir, Feutre , Penelope Clay, Penelope Argile, Vulcano, Graphite, Chanvre, Vison et Vert Pétrôle.**  
Les panneaux ont une bonne résistance à la flexion et à la traction et une excellente résistance au vieillissement et aux taches. Les chants sur le pourtour sont en ABS, collés avec de la colle polyuréthane et arrondis. Les panneaux de série sont classés en catégorie 2 pour ce qui concerne la réaction au feu. Disponible dans la version GALBÉ L.73xH.39 cm.

Les écrans privatifs latéraux peuvent être fixés au plateau à l'aide d'un kit composé d'un socle et d'une pince métallique disponibles en Blanc RAL9016 ou Anthracite Micacé ou bien fixés au plateau à l'aide d'une plaque de métal disponible en Blanc RAL9016 ou Anthracite Micacé.  
Cette dernière option permet de positionner librement l'écran privatif latéral.

#### ÉLÉMENTS MÉTALLIQUES SUSPENDUS

Réalisés en tôle 8/10 pliée et soudée, peints avec des poudres époxy dans les couleurs Blanc mat RAL9016 ou Anthracite Micacé. Tiroirs internes en métal avec coulisses à billes Quadro invisibles à fermeture amortie. Serrure fournie de série sur le premier tiroir, avec cylindre amovible et deux clés avec couvre-clé de protection pliant en ABS. Poignée latérale intégrée dans la façade du tiroir.  
Tous les éléments peuvent être fixés librement à la structure et sont faciles à déplacer grâce aux 4 clips en Nylon 6 renforcé fibre de verre (20 %) de couleur Blanc ou Anthracite fixés sur le top de l'élément à l'aide d'une paire de brides métalliques qui en facilitent le positionnement.  
Les éléments sont disponibles dans les configurations suivantes :  
• Un tiroir avec serrure L.32xP.50xH.10 cm  
• Deux tiroirs (tiroir du haut avec serrure) L.32xP.50xH.20 cm  
• Un tiroir avec serrure + niche L.32xP.50xH.40 cm  
• Deux tiroirs (tiroir du haut avec serrure) + niche L.32xP.50xH.40 cm  
P.S. : dimensions niche L.32xP.50xH.30 cm.

#### VOILE DE FOND

Réalisé en bois aggloméré de 18 mm d'épaisseur, avec une densité d'environ 650 kg/m<sup>3</sup> ; revêtement en mélaminé sur les deux côtés (grammage papier : 120 g/m<sup>2</sup>) ; traitement anti-rayures et antireflet.  
Finitions disponibles : **Ivoire, Béton Taloché, Orme Foncé, Orme Crème, Noyer Noir, Vulcano, Graphite, Chanvre, Vison et Vert Pétrôle.**  
Les panneaux ont une bonne résistance à la flexion et à la traction et une excellente résistance au vieillissement et aux taches. Les chants sur le pourtour sont en ABS, collés avec de la colle polyuréthane et arrondis.

## STILO \_SPÉCIFICATIONS TECHNIQUES

Les panneaux de série sont classés en catégorie 2 pour ce qui concerne la réaction au feu.  
Les panneaux sont fixés à la structure par une paire de brides métalliques de 3 mm d'épaisseur peintes avec des poudres époxy de couleur Blanc mat RAL9016 et Anthracite Micacé chaque support est muni d'un clip en Nylon 6 renforcé fibre de verre (20 %) de couleur Blanc ou Anthracite.

### BRAS PORTE-ÉCRAN

Réalisé en aluminium moulé sous pression et peint de couleur Blanc ou Noir, avec système d'équilibrage de l'écran à courroie qui permet l'application d'écrans de 0 à 9 kg. Réglage de l'équilibrage avec la molette, sans utilisation d'aucun outil. Rotation à 360° avec possibilité de bloquer la rotation à 180° (+90°/-90°). Plaque de fixation de l'écran à clip, rotation à 360° et fixation VESA 75 et 100.

### SUPPORT UC SUSPENDU

- **Modèle BIG** réalisé en tôle pliée peinte avec des poudres époxy de couleur Blanc mat RAL9016. Possibilité de réglage en hauteur de 37,7 à 53,2 cm et en largeur de 7,8 à 22 cm. Poids maximum UC : 15 kg.  
- **Modèle À SANGLE** composé d'un mécanisme tendeur avec sangle en nylon noir. La plaque métallique installée au-dessus du tendeur, lorsqu'elle est insérée dans une deuxième plaque galbée, en permet le coulissement et la rotation. Les deux plaques sont peintes avec des poudres époxy de couleur Aluminium RAL9006. Possibilité de réglage en hauteur de 24 à 50 cm et en largeur de 8 à 22,5 cm. Poids maximum UC : 15 kg.  
Tous les supports UC peuvent être fixés librement à la structure et sont faciles à déplacer grâce aux 4 clips en Nylon 6 renforcé fibre de verre (20 %) de couleur Blanc ou Anthracite fixés à l'aide d'une paire de brides métalliques qui en facilitent le positionnement.

### CANALISATION

#### CHEMIN DE CÂBLES pour BUREAUX DOUBLES

Réalisé en fil de fer diam. 4 mm peint avec des poudres époxy, couleur Blanc mat RAL9016 et Anthracite Micacé.  
Fixation à la structure à l'aide de 4 clips en Nylon 6 renforcé fibre de verre (20 %) de couleur Blanc ou Anthracite montés sur des supports spéciaux sur le chemin de câbles.  
Disponible dans les DIMENSIONS/versions suivantes :

- Pour plateaux intermédiaires L.60 et 80 cm
- Pour bureaux L.140 cm
- Pour bureaux L.160 cm
- Pour bureaux L.180 et 200 cm

#### CHEMIN DE CÂBLES pour BUREAUX SIMPLES

Réalisé en tôle d'acier pliée et peint avec des poudres époxy, couleur Blanc mat RAL9016 et Anthracite Micacé.  
Fourni avec bouchons de fermeture latéraux en Nylon 6 renforcé fibre de verre (10 %) de couleur Blanc ou Anthracite, avec clips serre-câbles intégrés. Les bouchons sont fixés à des charnières réalisées en Nylon 6 renforcé fibre de verre (10 %) de couleur Blanc ou Anthracite qui permettent la fixation à la structure et la rotation.  
Disponibles dans les DIMENSIONS suivantes :

- Pour bureaux L.80, 100, 120, 140, 160, 180 et 200 cm

#### VERTÈBRE PASSE-CÂBLES, MODÈLE STANDARD

Réalisée en polycarbonate transparent, longueur totale 81 cm.  
Base de 16,5 cm de diamètre réalisée en métal peint Aluminium.

#### VERTÈBRE PASSE-CÂBLES, MODÈLE PLUS

Passe-câbles vertical en spirale en métal et poils en nylon noir. Base et élément de fixation réalisés en zamak, finition Chrome Brillant.

#### TOP ACCESS

Réalisés en aluminium ; disponibles dans la finition peint Blanc ou Brill. L'ouverture du couvercle est disponible dans la version Frontale avec système de fermeture Soft-Close intégré ou dans la version DOUBLE (ouverture des deux côtés) grâce à des charnières spéciales en polycarbonate.  
Pour le support des multiprises, il est possible d'utiliser des boîtes à câbles appropriées (en option) ou les chemins de câbles (pour bureaux simples et doubles). Disponibles dans les dimensions suivantes : L.26,4 ou 45,4xP.12,5.

Tous les matériaux employés sont conformes aux normes UNI EN et sont certifiés CARB 2 (concernant l'émission de formaldéhyde) pour 90 % de la production.



# TABULA

DESIGN by PERIN&PARTNERS

Il design essenziale di TABULA si coniuga allo spirito di un sistema operativo ricco di tecnologie al servizio della persona.

Scrivanie regolabili in altezza sia meccanicamente che elettricamente, piani sliding, accessori e pannelli fonoassorbenti per creare un ambiente di lavoro pratico ed ergonomico.

The essential design of TABULA matches the spirit of a technology-based desk system at the service of people.

Mechanical and electrical height-adjustable desks, sliding tops, accessories and sound-absorbent panels to create a practical, ergonomic work environment.

Le design essentiel de TABULA s'allie à l'esprit d'un bureau opérationnel truffé de technologie au service de la personne.

Des bureaux réglables en hauteur à l'aide de systèmes mécaniques et électriques, des plateaux coulissants sliding, des accessoires et des panneaux acoustiques pour créer un environnement de travail pratique et ergonomique.



# TABULA **DESK** SCRIVANIE PROF. 80 / 60

# TABULA **BENCH** SCRIVANIE DOPPIE

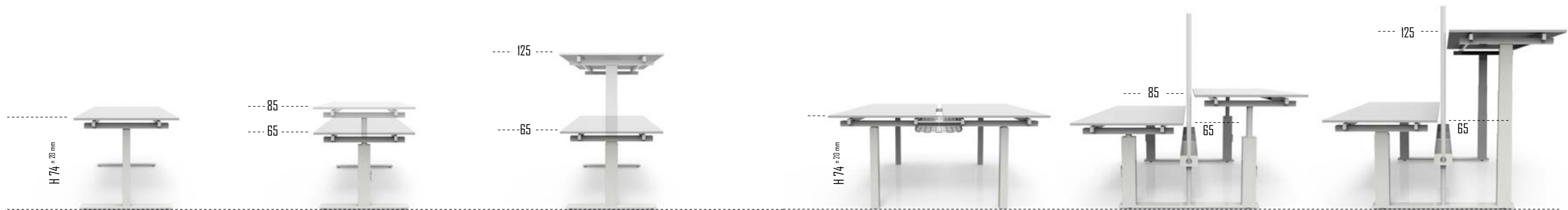

**FISSA**  
H 74 ± 20 mm

**ONE CLICK**  
H 65 ÷ 85

REGOLAZIONE  
A SCATTO MANUALE \_step 2 cm

**ELETTRICA**  
H 65 ÷ 125

REGOLAZIONE  
CONTINUA MOTORIZZATA

**FISSA**  
H 74 ± 20 mm

**ONE CLICK**  
H 65 ÷ 85

REGOLAZIONE  
A SCATTO MANUALE \_step 2 cm

**ELETTRICA**  
H 65 ÷ 125

REGOLAZIONE  
CONTINUA MOTORIZZATA

## HIGHLIGHTS

### QUICK FIX

La STRUTTURA viene assemblata comodamente e in rapidità dall'alto in piedi con 4 viti. Il PIANO viene montato con la tecnologia **QUICK FIX** senza l'utilizzo di ferramenta e attrezzi.

The framework is quick and easy to assemble from a standing position - with just four screws. The top is attached using **QUICK FIX** technology without the need for hardware and tools.

La structure est assemblée facilement et rapidement par le haut, debout, à l'aide de 4 vis. Le plateau est monté grâce à la technologie **QUICK FIX** sans l'emploi de quincaillerie ni d'outils.

### SLIDING TOP

Il PIANO di lavoro è predisposto per lo scorrimento **SLIDING TOP**, facilitando così l'accesso alle prese senza l'installazione di botole passacavi.

The **SLIDING TOP** makes it easy to access power and data without installing desk grommets.

Le plan de travail est disponible dans la version coulissante (**SLIDING**), ce qui facilite l'accès à la connectique sans l'installation d'obturateurs passe-câbles.

FISSA H 74  $\pm 20$  mm



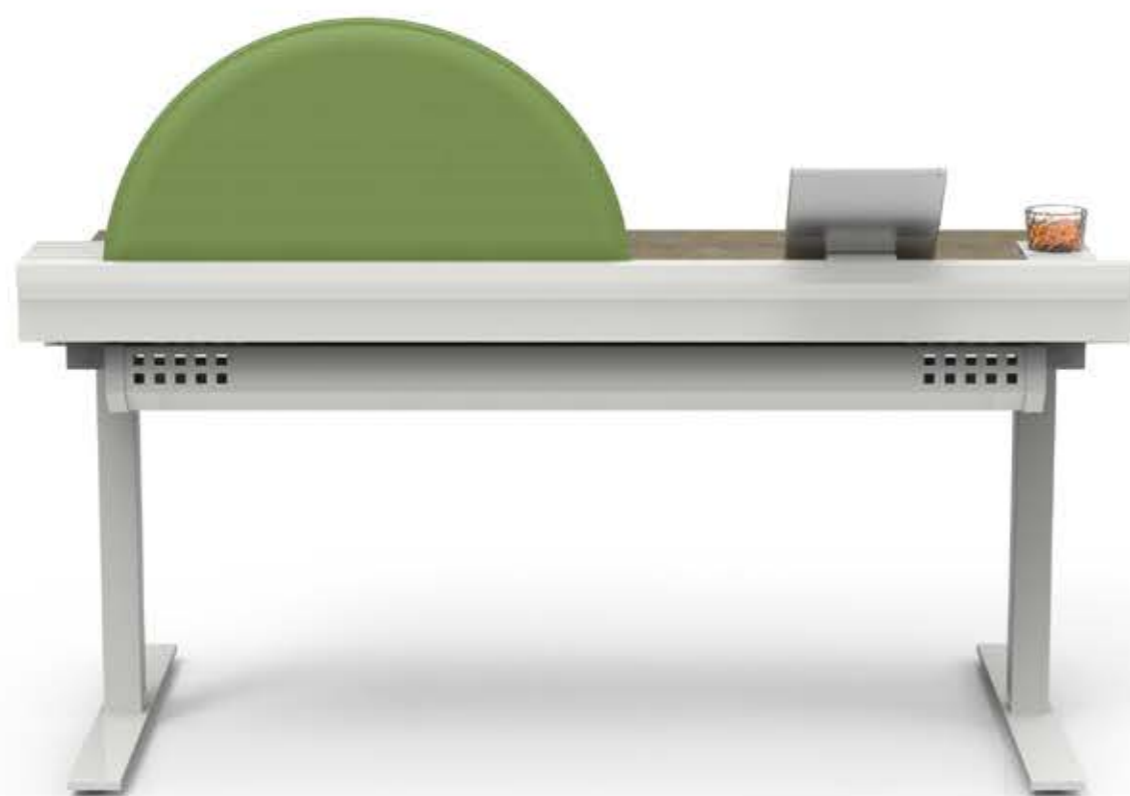

FISSA  
H 74 ± 20 mm

ONE CLICK  
H 65 ÷ 85

REGOLAZIONE  
A SCATTO MANUALE \_step 2cm

MANUAL ADJUSTMENT AT 2 CM STEPS  
RÉGLAGE MANUEL PAR CRANS DE 2 CM

85  
65





La REGOLAZIONE in altezza della scrivania è fondamentale per la salute della persona. Il particolare sistema a scatti ONE CLICK permette di determinare l'altezza del piano in modo autonomo tra i 65cm e gli 85cm.



A height-adjustment desk is essential to personal health. The special one click system makes it possible to independently set the height of the desktop at between 65 cm and 85 cm.

Le réglage en hauteur du bureau est fondamental pour la santé. Le système particulier à crans One Click permet de régler individuellement la hauteur du plateau entre 65 cm et 85 cm.



**ONE CLICK**  
H 65 ÷ 85

# ELETTRICA H 65 ÷ 125

REGOLAZIONE  
CONTINUA MOTORIZZATA

CONTINUOUS MOTORISED  
ELECTRICAL ADJUSTMENT  
ÉLECTRIQUE RÉGLAGE  
CONTINU MOTORISÉ





ELETTRICA  
H 65 ÷ 125



TABULA **BENCH** SCRIVANIE DOPPIE

FISSA H 74 ± 20 mm



## Flessibilità di sistema

Il sistema SLIDING funziona anche con postazioni in linea con gamba condivisa.

The sliding system also functions with side-by-side workstations that share legs.

Le système Sliding fonctionne également avec des postes de travail en rangée avec piètement partagé.



Il "concetto" di PRIVACY è risolto con alloggiamento di screen sia frontali, che laterali.

The concept of privacy is solved by inserting front and side screens.

Le « concept » de confidentialité est préservé grâce à des écrans privatifs frontaux et latéraux.



**FISSA**  
H 74 ± 20 mm



ONE CLICK  
H 65 ÷ 85

REGOLAZIONE  
A SCATTO MANUALE \_step 2cm

MANUAL ADJUSTMENT AT 2 CM STEPS  
RÉGLAGE MANUEL PAR CRANS DE 2 CM

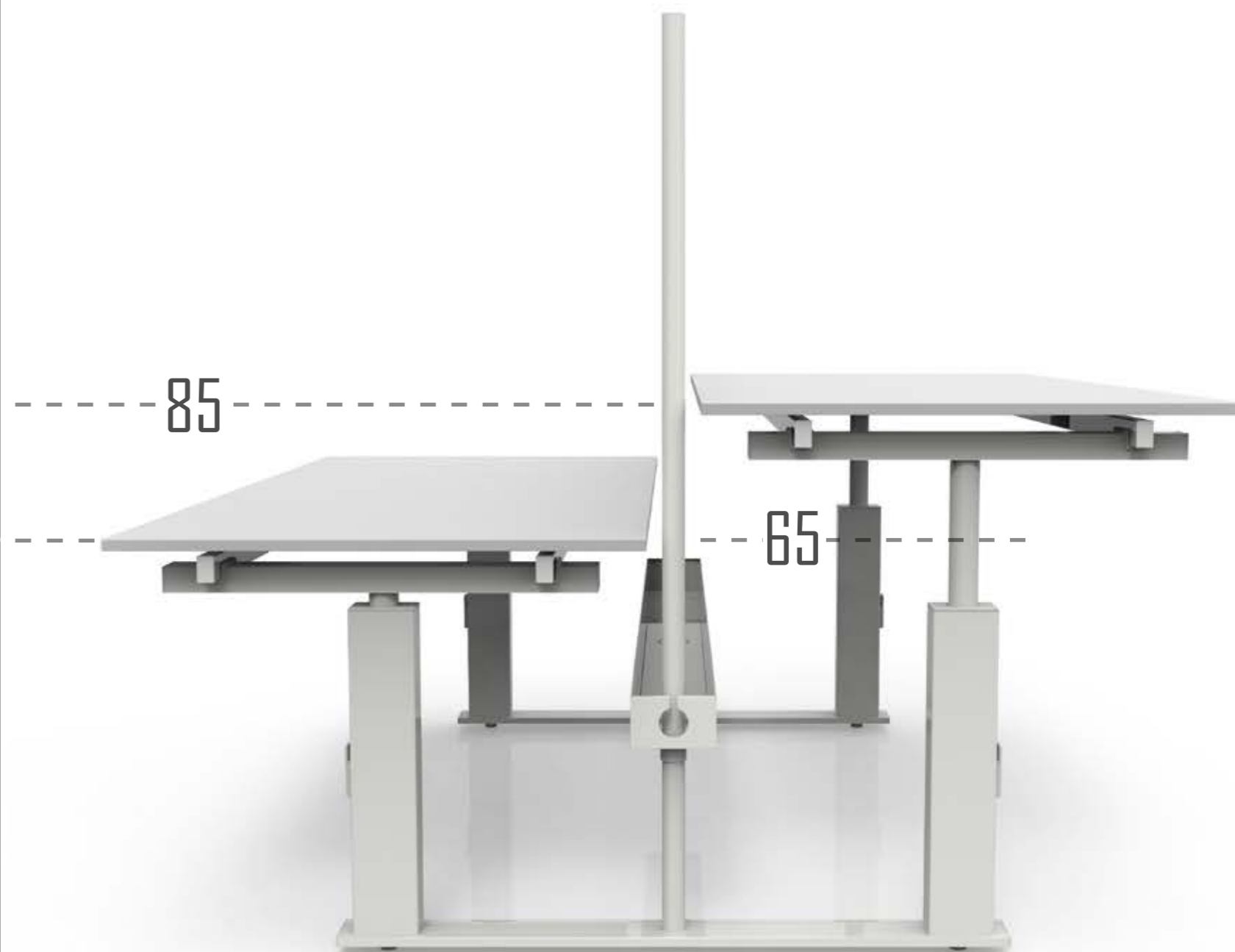



ONE CLICK  
H 65 ÷ 85

ELETTRICA  
H 65 ÷ 125

REGOLAZIONE  
CONTINUA MOTORIZZATA

CONTINUOUS MOTORISED  
ELECTRICAL ADJUSTMENT  
ÉLECTRIQUE RÉGLAGE  
CONTINU MOTORISÉ

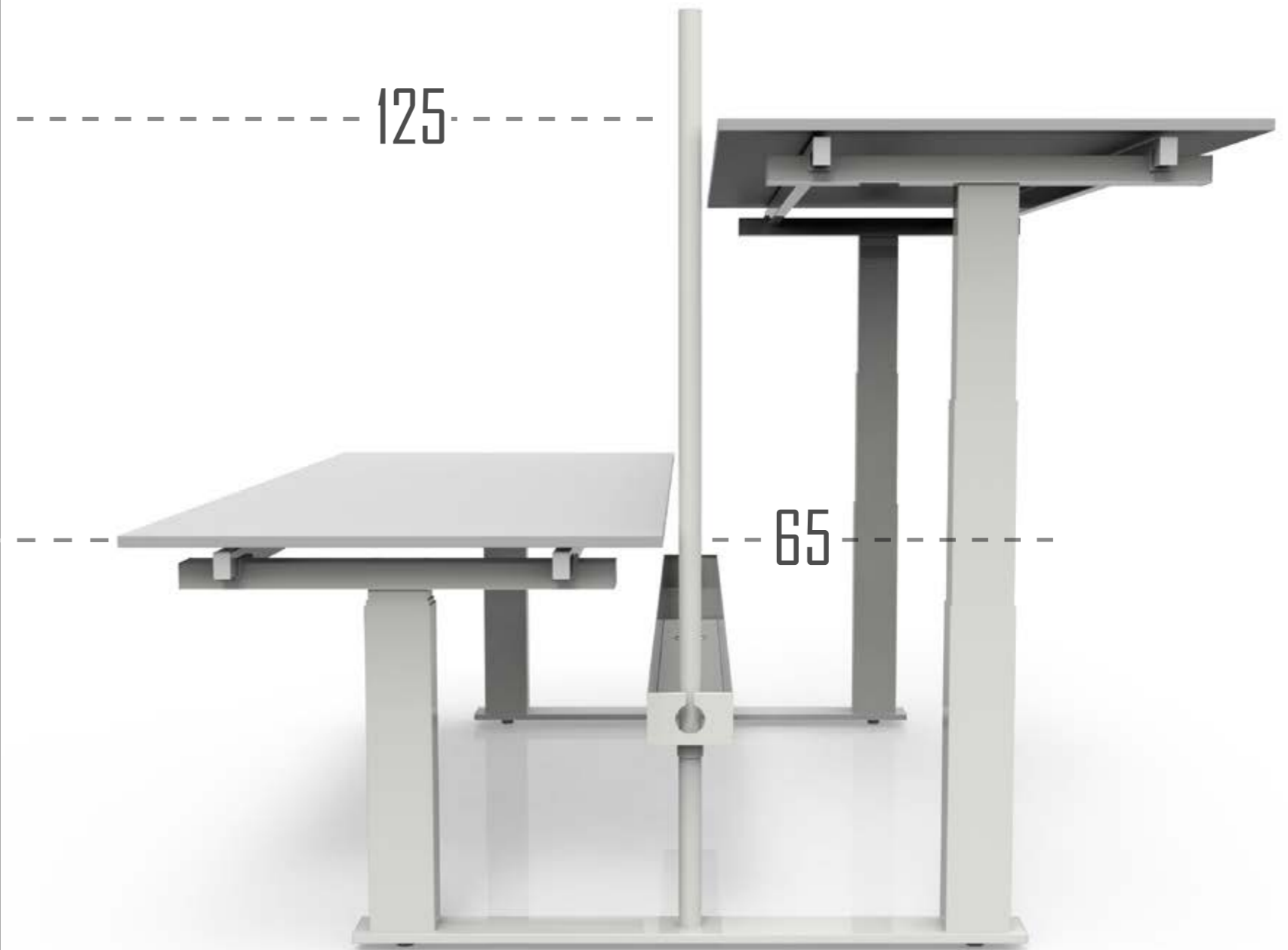



ELETTRICA  
H 65 ÷ 125





La struttura permette di ottenere superfici di grandi dimensioni, ideali per configurazioni workstation, hoteling e conferencing.

The framework can be set up to obtain large surface areas, perfect for workstation, hoteling and conference configurations.

La structure permet d'obtenir des surfaces de grandes dimensions, idéales pour les configurations de postes de travail, bureaux flexibles et tables de réunion.

## LA TECNOLOGIA



VASSOIO ACCUMULO CAVI IN FILO DI METALLO per scrivanie doppie ad altezza FISSA.

WIRE CABLE BASKET for double desks.

CHEMIN DE CÂBLES EN FIL MÉTALLIQUE pour bureaux doubles.

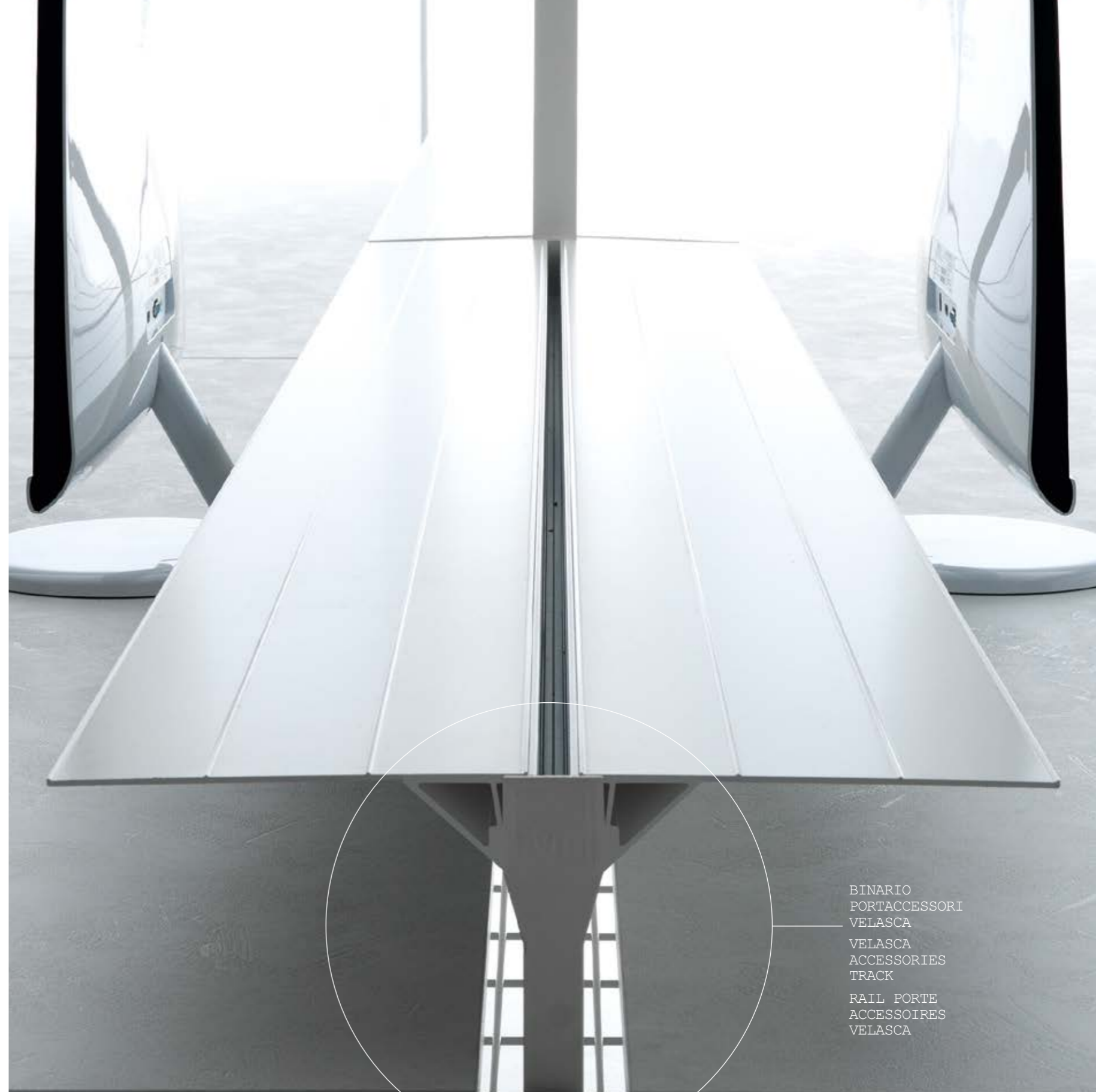

BINARIO PORTACCESSORI VELASCA  
VELASCA ACCESSORIES TRACK  
RAIL PORTE ACCESSOIRES VELASCA





VASSOIO ACCUMULO CAVI  
IN LAMIERA PRESSOPIEGATA  
per scrivanie singole (DESK)  
e per scrivanie doppie (BENCH)  
ad altezza REGOLABILE.

SHEET STEEL CABLE  
MANAGEMENT TRAY  
for single desks (DESK)  
and for HEIGHT-ADJUSTABLE  
BACK TO BACK DESKS (BENCH).

CHEMIN DE CÂBLES  
EN TÔLE PLIÉE  
pour bureaux simples (DESKS)  
et pour BUREAUX DOUBLES (BENCH)  
à HAUTEUR RÉGLABLE.



MULTIPRESA  
"COMBI"

MULTI-SOCKET  
MULTIPRISE  
"COMBI"



MULTIPRESA  
"BASE"  
Completa di STAFFA  
di AGGANCIO per PIANI

MULTI-SOCKET  
MULTIPRISE  
"BASE"



MULTIPRESA  
"CUSTOM"  
Completa di STAFFA di AGGANCIO  
per PIANI

MULTI-SOCKET  
MULTIPRISE  
"CUSTOM"



VERTEBRA PER PASSAGGIO CAVI  
modello STANDARD  
in policarbonato trasparente

CABLE MANAGEMENT VERTEBRAE  
STANDARD model  
transparent polycarbonate

VERTÈBRE PASSE-CABLE  
modèle STANDARD  
polycarbonate transparent



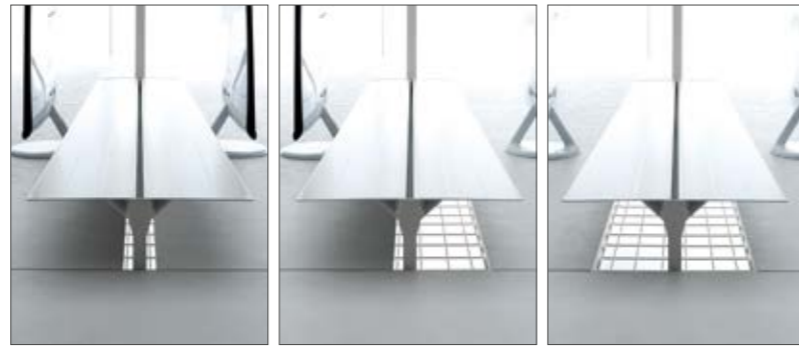

LIVELLI DI ATTREZZABILITÀ DEI PIANI

PIANO FIXED PIANO SLIDING



FIXED TOP  
PLATEAU FIXED

SLIDING TOP  
PLATEAU SLIDING

BINARIO VELASCA

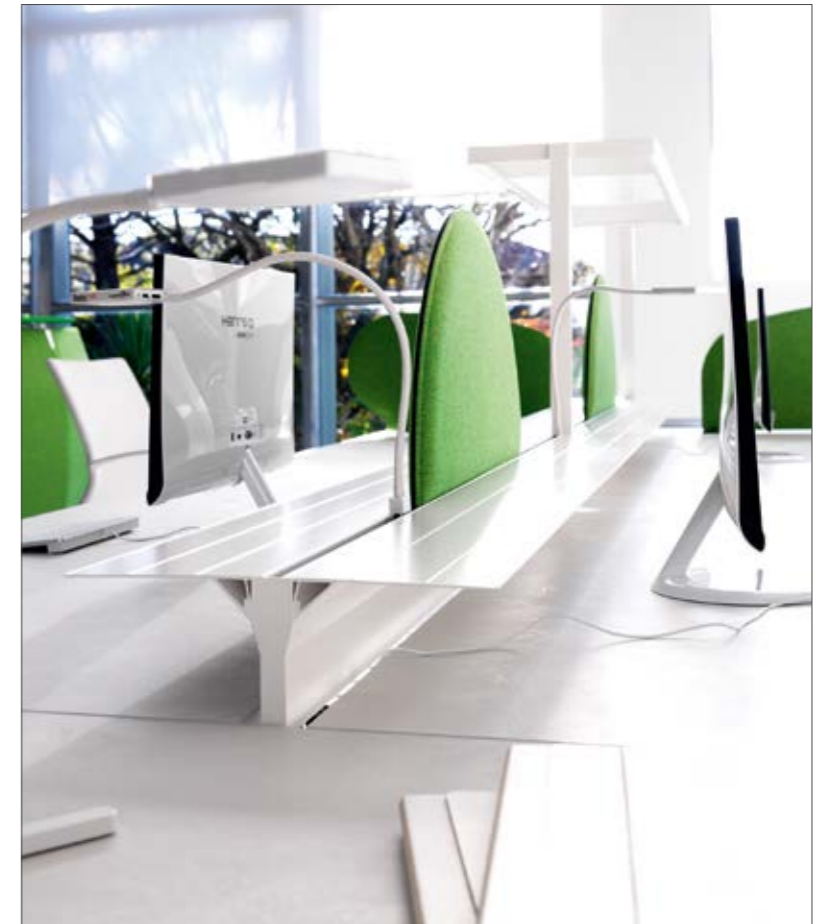

VELASCA TRACK  
RAIL VELASCA

Tutte le scrivanie SINGOLE e le scrivanie DOPPIE ad ALTEZZA FISSA del sistema TABULA possono essere completate dal BINARIO PORTACCESSORI VELASCA.

The SINGLE and DOUBLE desks of the TABULA system can be completed with the VELASCA ACCESSORIES TRACK.

Les bureaux SIMPLES OU DOUBLES du système TABULA peuvent être complétés par le RAIL PORTE-ACCESSOIRES VELASCA.

FITTING OPTIONS FOR TOPS  
NIVEAUX D'ÉQUIPEMENT DES PLATEAUX

BINARIO VELASCA \_ gli ACCESSORI



FINITURE<sup>dei</sup> PIANI  
TOP FINISHES  
FINITIONS<sup>DES</sup> PLATEAUX

Per una corretta valutazione di tonalità e colore delle diverse finiture rappresentate a catalogo, è necessario fare riferimento ai campioni fisici.

Due to variances in printed colours, see the swatches for the actual colours and shades of the different finishes.

Pour une évaluation correcte du ton et de la couleur des différentes finitions représentées dans le catalogue, il est nécessaire de se référer aux échantillons physiques.

ANTARCTITE

BIANCO PAL9016

Le GAMBE

LEGS  
LE PIÈTEMENT

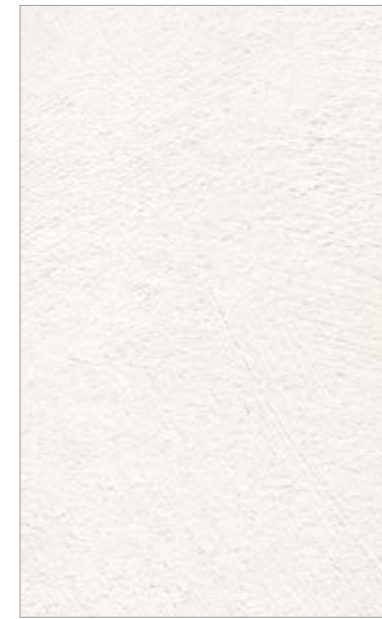

SPATOLATO CEMENTO  
CEMENT RENDER EFFECT / BÉTON TALOCHÉ



AVORIO  
IVORY / IVOIRE



GRAFITE  
GRAPHITE

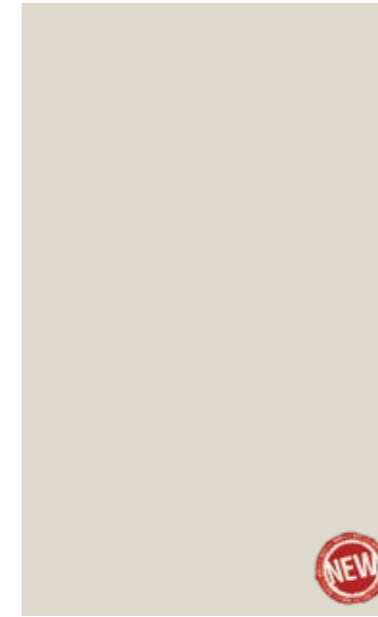

CANAPA  
WARM GREY / CHANVRE



VISONE  
MOSS GREY / VISON



OTTANIO  
PETROL GREEN / VERT PÉTROLE



VULCANO



OLMO PANNA  
ELM CREAM / ORME CRÈME



OLMO TESTA DI MORO  
ELM DARK BROWN / ORME FONCÉ



NOCE  
WALNUT / NOYER

NOBILITATO  
LAMINATE  
MELAMINÉ

LE FINITURE DEI PIANI SONO LIBERAMENTE ACCOSTABILI ALLE FINITURE PREVISTE PER LE GAMBE.

MATCH THE TOP FINISH WITH THE FINISH SELECTED FOR THE LEGS.

LES FINITIONS DES PLATEAUX SONT COMBINABLES AVEC LES FINITIONS PRÉVUES POUR LE PIÈTEMENT.

FINITURE <sup>degli</sup> SCREEN  
 SCREEN FINISHES  
 FINITIONS <sup>des</sup> ÉCRANS

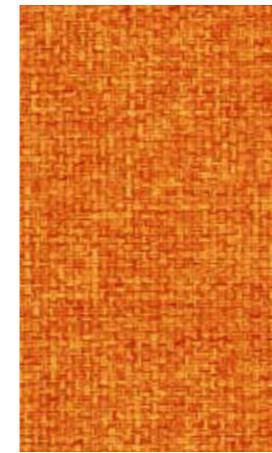

ARANCIO  
ORANGE

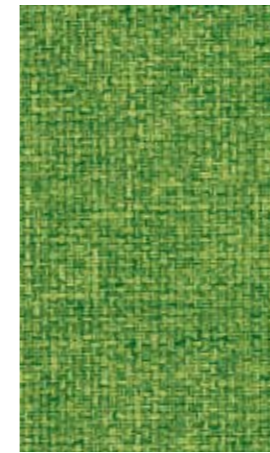

VERDE  
GREEN / VERT



AZZURRO  
BLUE / BLEU



SABBIA  
SAND / SABLE

**TESSUTO  
FONOASSORBENTE**

SOUND ABSORBING  
FABRIC

TISSU ACOUSTIQUE



GRAFITE  
GRAPHITE

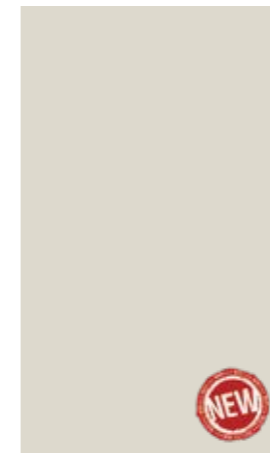

CANAPA  
WARM GREY / CHANVRE



VISONE  
MOSS GREY / VISON



OTTANIO  
PETROL GREEN / VERT PÉTROLE

**NOBILITATO**

LAMINATE  
MELAMINÉ

LE FINITURE DEGLI SCREEN  
SONO LIBERAMENTE ACCOSTABILI  
ALLE FINITURE PREVISTE  
PER I PIANI.

MATCH THE SCREEN  
FINISH WITH THE FINISH  
SELECTED FOR THE TOPS.

LES FINITIONS DES ÉCRANS SONT  
COMBINABLES AVEC LES FINITIONS  
PRÉVUES POUR LE PLATEAUX.



NOCE  
WALNUT / NOYER



VULCANO

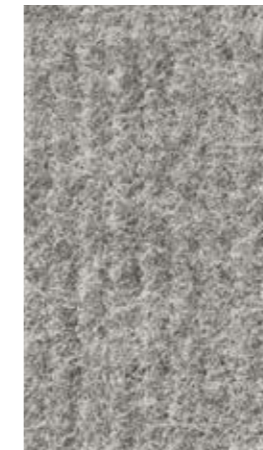

FELTRO  
FELT / FEUTRE



AVORIO  
IVORY / IVOIRE



SPATOLATO CEMENTO  
CEMENT RENDER EFFECT / BÉTON TALOCHÉ



OLMO PANNA  
ELM CREAM / ORME CRÈME



OLMO TESTA DI MORO  
ELM DARK BROWN / ORME FONCÉ



PENELOPE SABBIA  
PENELOPE SAND/SABLE



PENELOPE ARGILLA  
PENELOPE CLAY/ARGILE



ALLUMINIO  
ALUMINIUM

**CRISTALLO  
ACIDATO**

ETCHED GLASS  
VERRE ACIDÉ



## TABULA \_SPECIFICHE TECNICHE

SCRIVANIE, TAVOLI RIUNIONE, ALLUNGHI LATERALI composti da:

### PIANI LAVORO in NOBILITATO

Piani lavoro realizzati in conglomerato ligneo sp.18 mm, con densità di circa 650 Kg/m<sup>3</sup>, nobilitati su entrambi i lati mediante l'utilizzo di carte melaminiche a grammatura 120 gr/mq e con finitura superficiale antigraffio ed antiriflesso, nelle finiture **Avorio**, **Spatolato Cemento**, **Olmo Testa di Moro**, **Olmo Panna**, **Noce Canaletto**, **Vulcano**, **Grafite**, **Canapa**, **Visone** e **Ottanio**. I pannelli presentano una buona resistenza a flessione e trazione, ottima resistenza all'invecchiamento ed alle macchie. I bordi perimetrali sono costituiti da una miscela in ABS, incollati con colla poliuretanica ed arrotondati. La reazione al fuoco dei pannelli utilizzati di serie è compresa nella classe seconda.

Ogni piano viene fornito con **tecnologia QUICK FIX** (sistema che permette il posizionamento dei piani senza l'utilizzo di ferramenta) **già montata** ed \_in base alla richiesta del cliente\_ è dotato di sistema di aggancio **FIXED** o di sistema di aggancio scorrevole **SLIDING TOP**. Entrambi i sistemi sono composti da n° 4 slitte e n° 2 maniglie realizzate in Nylon6 FV15% in colore Alluminio.

### GAMBE METALLICHE FISSE

(Tipo C Rif. Normativa EN 527-1:2011)

Gambe metalliche previste in 5 tipologie dimensionali prof. 60, 80, 90, 125 e 165 cm. Le gambe prof. 60, 80 e 90 sono composte da un traverso superiore orizzontale in tubolare metallico a sezione rettangolare 60x40x sp. 2 mm, da un montante verticale realizzato in tubolare metallico sezione quadrata 60x60x sp. 2 mm collegato al traverso tramite un tubolare metallico a sezione tonda diam. 45x sp. 2 mm che lo distanza di 10 mm e da un piede in Tubolare metallico a sezione rettangolare 80x15x sp. 2 mm. Sia i piedi che i puntali sono dotati di piedini regolabili con escursione di 20 mm (per un perfetto livellamento al pavimento).

Le gambe prof. 125 e 165 cm sono composte da un traverso superiore orizzontale in tubolare metallico a sezione rettangolare 60x40x sp. 2 mm e da due montanti verticali realizzati in tubolare metallico sezione quadrata 60x60x sp. 2 mm collegati al traverso tramite un tubolare metallico a sezione tonda diam. 45x sp. 2 mm che li distanza di 10 mm.

Tutte le tipologie di gambe sono verniciate con polveri epossidiche nei colori, Bianco opaco Ral 9016 e Antracite Micalizzato. Sul traverso orizzontale sono premontate due o quattro selle (due per le gambe prof. 60, 80 e 90 e quattro per le gambe prof. 125 e 165) in Nylon6 FV20% nei colori Bianco o Antracite con funzioni di aggancio traversi. Le gambe sono corredate di tappi e puntali entrambi realizzati in ABS stampato nei colori Bianco o Antracite. Sia i piedi che i puntali sono dotati di piedini regolabili con escursione di 20 mm (per un perfetto livellamento al pavimento). Le gambe intermedie si ottengono mediante l'applicazione, durante le fasi di montaggio, di un particolare costampato in metallo e Nylon6 FV20% in color Alluminio inserito nelle selle presenti sul traverso orizzontale.

### GAMBE METALLICHE CON REGOLAZIONE IN ALTEZZA A DUE STADI\_ DA 65 A 85 CM\_ CON PULSANTE \_ nome commerciale "ONE CLICK"

(Tipo B Rif. Normativa EN 527-1:2011)

Gambe metalliche previste in 5 tipologie dimensionali prof. 60, 80, 90, 125 e 165 cm. Le gambe prof. 60, 80 e 90 sono composte da un traverso orizzontale in tubolare metallico a sezione rettangolare 60x40x sp. 2 mm e da un montante interno verticale realizzato in tubolare metallico sezione Tonda diam. 45x sp. 2 mm. Sul montante sono presenti sia le tacche che la scala di regolazione passo 20 mm (ricavata tramite stampo di coniatura). La regolazione è ottenuta grazie ad un secondo montante verticale esterno in tubolare metallico sezione rettangolare 100x60x sp. 2 mm sul quale è montato il pulsante a scatto in Nylon6 FV20% nei colori Bianco o Antracite che ne permette la regolazione da un minimo di 65 cm ad un massimo di 85 cm con intervalli di 2 cm. Il montante esterno è dotato di un piede realizzato in tubolare di metallo a sezione rettangolare 80x15x sp. 2 mm. Le gambe prof. 125 e 165 cm sono composte da due traversi orizzontali in tubolare metallico a sezione rettangolare 60x40x sp. 2 mm e da due montanti interni verticali realizzati in tubolare metallico sezione tonda diam. 45x sp. 2 mm. Sui montanti sono presenti sia le tacche che la scala di regolazione passo 20 mm (ricavata tramite stampo di coniatura). La regolazione è ottenuta grazie ad un seconda coppia di montanti verticali esterni in tubolare metallico sezione rettangolare 100x60x sp. 2 mm sui quali è montato il pulsante a scatto in Nylon6 FV20% nei colori Bianco o Antracite che ne permette la regolazione da un minimo di 65 cm ad un massimo di 85 cm con intervalli di 2 cm. I due montanti esterni sono collegati tramite un piede realizzato in tubolare di metallo a sezione rettangolare 80x15x sp. 2 mm. Questa soluzione permette la possibilità di regolare le altezze dei piani contrapposti in maniera indipendente. Tutte le tipologie di gambe sono verniciate con polveri epossidiche nei colori Bianco opaco Ral 9016 o Antracite Micalizzato. Sul traverso orizzontale sono premontate due o quattro selle (due per le gambe P. 600, 800 e 900 e quattro per le gambe P. 1250 e 1650) in Nylon6 FV20% nei colori Bianco o Antracite con funzioni di aggancio traversi. Le gambe sono corredate di tappi e puntali entrambi realizzati in ABS stampato nei colori Bianco o Antracite. I piedi sono dotati di piedini regolabili con escursione di 20 mm (per un perfetto livellamento al pavimento). Le gambe intermedie si ottengono mediante l'applicazione, durante le fasi di montaggio, di un particolare costampato in metallo e Nylon6 FV20% in color Alluminio inserito nelle selle presenti sul traverso orizzontale.

### GAMBE METALLICHE CON REGOLAZIONE IN ALTEZZA A TRE STADI \_DA 65 A 125 CM\_ CONTINUA MOTORIZZATA

(Tipo A Rif. Normativa EN 527-1:2011)

Gambe metalliche previste in 5 tipologie dimensionali prof. 60, 80, 90, 125 e 165 cm. Le gambe prof. 60, 80 e 90 sono composte da un traverso superiore orizzontale in tubolare metallico a sezione rettangolare 60x40x sp. 2 mm, da un piede in Tubolare metallico a sezione rettangolare 80x15x sp. 2 mm, e da una colonna di sollevamento motorizzata disponibile in due versioni (vedi caratteristiche a fine capitolo). Le gambe prof. 125 e 165 cm sono composte da due traversi orizzontali in tubolare metallico a sezione rettangolare 60x40x sp. 2 mm e da una coppia di colonne di sollevamento motorizzate disponibili in due versioni (vedi caratteristiche a fine capitolo). Le due colonne sono collegate tramite un piede realizzato in tubolare di metallo a sezione 80x15x sp. 2 mm. Questa soluzione permette la possibilità di regolare le altezze dei piani contrapposti in maniera indipendente. Tutte le tipologie di gambe sono verniciate con polveri epossidiche nel **SOLO colore Bianco opaco Ral 9016**. Sul traverso orizzontale sono premontate due o quattro selle (due per le gambe P. 600, 800 e 900 e quattro per le gambe P. 1250 e 1650) in Nylon6 FV20% nel colore Bianco con funzioni di aggancio traversi. Le gambe sono corredate di tappi e puntali entrambi realizzati in ABS stampato nel colore Bianco. I piedi sono dotati di piedini regolabili con escursione di 20 mm (per un perfetto livellamento al pavimento). **ATTENZIONE:** Nella versione con colonne motorizzate NON È PREVISTA LA GAMBA INTERMEDIA.

## CARATTERISTICHE SISTEMI DI REGOLAZIONE MOTORIZZATI

### SISTEMI DI REGOLAZIONE LINAK

Sistema composto da due colonne a tre stadi a sezione rettangolare 100x60 mm completa di sensore anti-collisione che riduce al minimo il rischio di eventuali danni del tavolo sia in direzione di salita che di discesa. Movimento sincronizzato del profilo medio. Cuscinetti di scorrimento interni invisibili per garantire la massima fluidità e silenziosità di movimento. Centralina di controllo con protezione contro sovraccarichi elettronici con funzione soft start/stop, consumo di corrente in modalità standby di soli 0,1 W, cavo di alimentazione intercambiabile. Comandi di controllo disponibili in due versioni:

- **BASIC**\_Pulsantiera dotata dei soli comandi di salita e discesa disponibile nei colori Bianco e Nero
- **PLUS**\_Pulsantiera dotata dei comandi di salita e discesa, di un display a LED per visualizzare l'altezza del piano e di tre tasti per memorizzare altezze desiderate, disponibile nei colori Bianco e Nero. Il display, se non utilizzato si spegne autonomamente risparmiando energia.

Tutti i componenti sono prodotti senza impiego di materiali in PVC per un sistema più ecologico a beneficio dell'ambiente.

Il sistema Linak è PREDISPOSTO per i seguenti collegamenti:

**Ricevitore Bluetooth** (anche in un secondo momento) che consente di gestire tutte le funzioni del sistema tramite computer o apposita App. Non necessita di alcun montaggio, basta inserire l'unità nella porta della centralina per la connessione tra i dispositivi.

**Scheda IOT** che consente oltre a tutte le funzioni del ricevitore Bluetooth di connettere la scrivania alla tecnologia IOT.

## TABULA \_SPECIFICHE TECNICHE

### SISTEMI DI REGOLAZIONE OKIN

Sistema composto da due colonne a tre stadi a sezione rettangolare 80x62 mm completa di sensore anti-collisione che riduce al minimo il rischio di eventuali danni del tavolo sia in direzione di salita che di discesa. Movimento sincronizzato del profilo medio. Cuscinetti di scorrimento interni invisibili per garantire la massima fluidità e silenziosità di movimento. Centralina di controllo con protezione contro sovraccarichi elettronici con funzione soft start/stop, consumo di corrente in modalità standby di soli 0,3 W, cavo di alimentazione intercambiabile. Comandi di controllo disponibili in due versioni:

- **BASIC**\_Pulsantiera dotata dei soli comandi di salita e discesa disponibile nel colore Nero
- **PLUS**\_Pulsantiera dotata dei comandi di salita e discesa, di un display a LED per visualizzare l'altezza del piano e di quattro tasti per memorizzare altezze desiderate, disponibile nel colore Nero. Il display, se non utilizzato si spegne autonomamente risparmiando energia.

### TRAVERSI STRUTTURALI

Sono realizzati in tubolare metallico a sezione rettangolare 25x40x sp. 2 mm verniciati con polveri epossidiche nei colori, Bianco Opaco Ral 9016 e Antracite Micalizzato. Ogni trave è corredata da una coppia di particolari in Nylon6 FV20% nei colori Bianco o Antracite per l'aggancio dei piani con **tecnologia QUICK FIX** (sistema che permette il posizionamento dei piani senza l'utilizzo di ferramenta) ed \_in base alla richiesta del cliente\_ è dotato di sistema di aggancio **FIXED** o di sistema di aggancio scorrevole **SLIDING TOP**. Tutti i traversi sono corredate nelle estremità di tappi terminali realizzati in ABS colore Bianco o Antracite asportabili in caso di utilizzo con gambe intermedie.

I traversi degli allunghi sono ottenuti utilizzando i medesimi traversi delle scrivanie con l'aggiunta di un Kit di aggancio in Nylon6 FV20% nei colori Bianco o Antracite composto da due staffe più un distanziale regolabile per le profondità del piano p.600 e p.800 mm.

PENISOLA composta da:

(Utilizzabile solo con scrivanie Altezza FISSA)

### ELEMENTI CONTENITORI

Scocca realizzata in conglomerato ligneo sp.18 mm, placcato da entrambi i lati in nobilitato resistente all'abrasione nei colori **Avorio** o **Penelope Argilla**. Ante, Frontali Cassetti e Schienali abbinati realizzati in conglomerato ligneo sp.18 mm, placcato da entrambi i lati in nobilitato resistente all'abrasione nelle finiture **Avorio**, **Spatolato Cemento**, **Olmo Testa di Moro**, **Olmo Panna**, **Noce Canaletto**, **Vulcano**, **Grafite**, **Canapa**, **Visone** e **Ottanio**. Serratura dotata di cilindro estraibile con chiave pieghevole antifurtunio in duplice copia e impugnatura coprichiave in ABS. Maniglia in Zama disponibile nei colori Bianco opaco Ral 9016 e Antracite Micalizzato. Cassettiera dotata di cassette interni sp.12 mm, rivestiti in PVC Penelope grigio. Guide metalliche Quadro (scorrevoli su sfere) a scomparsa con rientro soft. Serratura a chiusura simultanea di tutti i cassettei.

### SET DI FINITURA

Realizzato in conglomerato ligneo sp.18 mm, placcato da entrambi i lati in nobilitato resistente all'abrasione nei colori **Avorio**, **Spatolato Cemento**, **Olmo Testa di Moro**, **Olmo Panna**, **Noce Canaletto**, **Vulcano**, **Grafite**, **Canapa**, **Visone** e **Ottanio**. Base dotata di piedini regolabili colore nero.

### SUPPORTO di COLLEGAMENTO MOBILE SCRIVANIE

Il supporto, disponibile per piani profondità 80, 90, 125 e 165 cm, è composto da un traverso orizzontale in tubolare metallico a sezione rettangolare 60x40x sp. 2 mm e da due distanziali realizzati in ABS stampato nei colori Bianco o Antracite. Tutte le tipologie di supporti sono verniciati e con polveri epossidiche nei colori, Bianco opaco Ral 9016 e Antracite Micalizzato. Sul traverso sono premontate due o quattro selle (due per le gambe P.80 e 90 e quattro per le gambe P.125 e 165) in Nylon6 FV20% nei colori Bianco o Antracite con funzioni di aggancio traversi. I supporti sono corredate di tappi realizzati in ABS stampati nei colori Bianco o Antracite.

## VELASCA

### PROFILO VELASCA

Composto da un profilo estruso in lega di alluminio EN AW-6060 verniciato con polveri epossidiche nei colori Bianco opaco Ral 9016 e Antracite Micalizzato. Il profilo è agganciato alla struttura tramite due staffe in Nylon6 FV 20% in color Bianco o Antracite. Il profilo è corredate di tappi realizzati in ABS stampati nei colori Bianco o Antracite.

### SCREEN FRONTALI PER VELASCA disponibili nei seguenti materiali:

- **TESSUTO** nei colori Melange Arancio, Verde, Azzurro e Sabbia, con materasso fonoassorbente a densità variabile ottenuta attraverso la termoformatura del materiale con stampo in alluminio. Questa tecnica consente di ottenere un manufatto in grado di assorbire un più ampio spettro di lunghezze d'onda. I pannelli, inseriti nella Velasca mediante due mollette in ABS, sono facilmente posizionabili. Disponibili nelle configurazioni a Semicerchio (L.76 x H.39 cm) e Rettangolare (77, 117, 137 e 157 x H.39 cm).
- **NOBILITATO** realizzati in conglomerato ligneo sp.18 mm, con densità di circa 650 Kg/m<sup>3</sup>, nobilitati su entrambi i lati mediante l'utilizzo di carte melaminiche a grammatura 120 gr/mq e con finitura superficiale antigraffio ed antiriflesso, nelle finiture **Avorio**, **Spatolato Cemento**, **Olmo Testa di Moro**, **Olmo Panna**, **Noce Canaletto**, **Vulcano**, **Grafite**, **Canapa**, **Visone** e **Ottanio**. I pannelli presentano una buona resistenza a flessione e trazione, ottima resistenza all'invecchiamento ad alle macchie. I bordi perimetrali sono costituiti da una miscela in ABS, incollati con colla poliuretanica ed arrotondati. La reazione al fuoco dei pannelli utilizzati di serie è compresa nella classe seconda. I pannelli, inseriti nella velasca mediante due mollette in ABS, sono facilmente posizionabili. Disponibili nella configurazione RETTANGOLARE.
- **CRISTALLO** realizzati in cristallo float Acidato sp.8 mm Temperato. I pannelli, inseriti nella velasca mediante due mollette in ABS, sono facilmente posizionabili. Disponibili nella configurazione RETTANGOLARE.

### MENSOLA VELASCA

Composta da un profilo estruso in lega di alluminio EN AW-6060 verniciato con polveri epossidiche nei colori, Bianco opaco Ral 9016 e Antracite Micalizzato. Le mensole si agganciano liberamente alla Velasca e possono essere facilmente spostate e riposizionate.

### ACCESSORI VELASCA

Composti da un profilo estruso in lega di alluminio EN AW-6060 verniciato con polveri epossidiche nei colori, Bianco opaco Ral 9016 e Antracite Micalizzato. Gli accessori si agganciano liberamente alla Velasca e possono essere facilmente spostate e riposizionati.

Disponibili nelle seguenti funzioni:

- Porta matite L.10 x P.14 cm completo di porta matite in plastica Trasparente
- Porta tazza termica L.10 x P.14 cm completo di tazza termica
- Porta cellulare L.10 x P.14 cm
- Porta prese L.25 x P.14 cm completo di multipresa con 3 prese combinate Schuko-Italia

## TABULA \_SPECIFICHE TECNICHE

### COMPLEMENTI

#### SCREEN FRONTALI \_ UTILIZZABILI CON SCRIVANIE ad ALTEZZA FISSA E REGOLABILE e CON BENCH ad ALTEZZA FISSA

Disponibili nei seguenti materiali:

- **TESSUTO** nei colori Melange Arancio, Verde, Azzurro e Sabbia, con materassino fonoassorbente a densità variabile ottenuta attraverso la termoformatura del materiale con stampo in alluminio. Questa tecnica consente di ottenere un manufatto in grado di assorbire un più ampio spettro di lunghezze d'onda. Disponibili nelle configurazioni a Semicerchio (L.76 x H.39 cm) e Rettangolare (77, 117, 137 e 157 x H.39 cm)
- **NOBILITATO** realizzati in conglomerato ligneo sp.18 mm, con densità di circa 650 Kg/m<sup>3</sup>, nobilitati su entrambi i lati mediante l'utilizzo di carte melaminiche a grammatura 120 gr/mq e con finitura superficiale antigraffio ed antiriflesso, nelle finiture Avorio, Spatolato Cemento, Olmo Testa di Moro, Olmo Panna, Noce Canaletto, Vulcano, Grafite, Canapa, Visone e Ottanio.

I pannelli presentano una buona resistenza a flessione e trazione, ottima resistenza all'invecchiamento ad alle macchie.

I bordi perimetrali sono costituiti da una miscela in ABS, incollati con colla poliuretanicca ed arrotondati.

La reazione al fuoco dei pannelli utilizzati di serie è compresa nella classe seconda.

Disponibili nella configurazione RETTANGOLARE.

- **CRISTALLO** realizzati in cristallo float Acidato sp.8 mm Temperato. Disponibili nella configurazione RETTANGOLARE.

Tutti gli screen sono agganciati alla struttura mediante due staffe in Nylon6 FV20% in color Bianco o Antracite, dotate di due morsetti a pinza in Nylon6 FV20% in color Bianco o Antracite.

#### SCREEN LATERALE disponibile nei seguenti materiali

- **TESSUTO** nei colori Melange Arancio, Verde, Azzurro e Sabbia, con materassino fonoassorbente a densità variabile ottenuta attraverso la termoformatura del materiale con stampo in alluminio. Questa tecnica consente di ottenere un manufatto in grado di assorbire un più ampio spettro di lunghezze d'onda. Disponibili nelle configurazioni SAGOMATO L.73 x H.39 cm
- **NOBILITATO** realizzati in conglomerato ligneo sp.18 mm, con densità di circa 650 Kg/m<sup>3</sup>, nobilitati su entrambi i lati mediante l'utilizzo di carte melaminiche a grammatura 120 gr/mq e con finitura superficiale antigraffio ed antiriflesso, nelle finiture Avorio, Spatolato Cemento, Olmo Testa di Moro, Olmo Panna, Noce Canaletto, Vulcano, Grafite, Canapa, Visone e Ottanio.

I pannelli presentano una buona resistenza a flessione e trazione, ottima resistenza all'invecchiamento ed alle macchie.

I bordi perimetrali sono costituiti da una miscela in ABS, incollati con colla poliuretanicca ed arrotondati.

La reazione al fuoco dei pannelli utilizzati di serie è compresa nella classe seconda.

Disponibili nelle configurazioni SAGOMATO L.73 x H.39 cm

Gli screen laterali possono essere agganciati alla piano mediante un Kit composto da una staffa di appoggio e da un morsetto metallico disponibili nei colori Bianco Ral 9016 o Antracite Micalizzato oppure appoggiati al piano mediante l'utilizzo di una piastra in metallo disponibile nei colori Bianco Ral 9016 o Antracite Micalizzato. Quest'ultima opzione rende lo screen laterale liberamente posizionabile.

#### SCREEN FRONTALI \_ UTILIZZABILI SOLO con BENCH ad ALTEZZA REGOLABILE (ONECLICK O ELETTRICA)

Disponibili nei seguenti materiali:

- **TESSUTO** nei colori Melange Arancio, Verde, Azzurro e Sabbia, con materassino interno rifinito con impunture a disegno quadrato.

Sono disponibili in configurazione Rettangolare nelle dimensioni L.128, 148,168 e 188 x H.105 cm

Struttura portante composta da due tubolari verticali di metallo a sezione Tonda diam. 35x sp. 2 mm e da un traverso orizzontale in tubolare di metallo sezione 30x30x sp. 2 mm verniciata con polveri epossidiche nei colori, Bianco opaco Ral 9016 e Antracite Micalizzato.

La struttura è corredata di tappi realizzati in ABS stampato nei colori Bianco o Antracite.

- **NOBILITATO** realizzati in conglomerato ligneo sp.18 mm, con densità di circa 650 Kg/m<sup>3</sup>, nobilitati su entrambi i lati mediante l'utilizzo di carte melaminiche a grammatura 120 gr/mq e con finitura superficiale antigraffio ed antiriflesso, nelle finiture Avorio, Spatolato Cemento, Olmo Testa di Moro, Olmo Panna, Noce Canaletto, Vulcano, Grafite, Canapa, Visone e Ottanio.

I pannelli presentano una buona resistenza a flessione e trazione, ottima resistenza all'invecchiamento ad alle macchie.

I bordi perimetrali sono costituiti da una miscela in ABS, incollati con colla poliuretanicca ed arrotondati.

La reazione al fuoco dei pannelli utilizzati di serie è compresa nella classe seconda.

Sono disponibili in configurazione Rettangolare nelle dimensioni L.128, 148,168 e 188 x H.105 cm.

Struttura portante composta da due tubolari verticali di metallo a sezione Tonda diam. 35x sp. 2 mm verniciata con polveri epossidiche nei colori, Bianco opaco Ral 9016 e Antracite Micalizzato. La struttura è corredata di tappi realizzati in ABS stampato nei colori Bianco o Antracite.

**ATTENZIONE:** per il montaggio di questa tipologia di screen è obbligatorio acquistare anche il VASCONE ACCUMULO CAVI PER TABULA BENCH AD ALTEZZA REGOLABILE.

#### ELEMENTI PENSILI IN METALLO

Realizzati in lamiera piegata e saldata 8/10, verniciati con polveri epossidiche nei colori Bianco opaco Ral 9016 oppure Antracite Micalizzato.

Cassetti interni in Metallo completi di guide Quadro (scorrevoli su sfere) a scomparsa con rientro soft. Serratura disponibile di serie sul primo cassetto, dotata di cilindro estraibile con chiave pieghevole antifurto in duplice copia e impugnatura coprichiave in ABS.

Maniglia laterale integrata nel frontale cassetto. Tutti gli elementi sono liberamente agganciabili alla struttura e facilmente spostabili grazie all'utilizzo di 4 clip in Nylon6 FV20% in color Bianco o Antracite montate sul top dell'elemento tramite una coppia di staffe metalliche che ne agevolano il posizionamento.

Gli elementi sono disponibili nelle seguenti configurazioni:

- Un cassetto con serratura \_ L.32 x P.50 x **H.10 cm**
- Due cassetti (primo cassetto dotato di serratura) \_ L.32 x P.50 x **H.20 cm**
- Un cassetto con serratura + vano \_ L.32 x P.50 x **H.40 cm**
- Due cassetti (primo cassetto dotato di serratura) + vano \_ L.32 x P.50 x **H.40 cm**

P.S.: dimensioni Vano L.32 x P.50 x H.30 cm

#### MODESTY PANEL

Realizzati in conglomerato ligneo sp.18 mm, con densità di circa 650 Kg/m<sup>3</sup>, nobilitati su entrambi i lati mediante l'utilizzo di carte melaminiche a grammatura 120 gr/mq e con finitura superficiale antigraffio ed antiriflesso, nelle finiture Avorio, Vulcano, Spatolato Cemento, Olmo Testa di Moro, Olmo Panna, Noce Canaletto, Vulcano, Grafite, Canapa, Visone e Ottanio.

I pannelli presentano una buona resistenza a flessione e trazione, ottima resistenza all'invecchiamento ad alle macchie.

I bordi perimetrali sono costituiti da una miscela in ABS, incollati con colla poliuretanicca ed arrotondati.

La reazione al fuoco dei pannelli utilizzati di serie è compresa nella classe seconda.

I pannelli sono agganciati alla struttura tramite una coppia di staffe metalliche sp. 3 mm verniciate con polveri epossidiche nei colori, Bianco opaco Ral 9016 e Antracite Micalizzato su ogni staffa è applicata una clip in Nylon6 FV20% in color Bianco o Antracite.

#### BRACCIO PORTA MONITOR

Realizzato in pressofusione di alluminio verniciato nei colori Bianco o Nero, con sistema di bilanciamento monitor a cinghia che permette l'applicazione di monitor da 0 a 9 kg. Regolazione bilanciamento tramite rotella, senza l'utilizzo di nessun utensile. Rotazione a 360° con possibilità di bloccarne la rotazione a 180° (+90°/-90°). Piastra per aggancio monitor a clip, rotazione 360° ed attacco VESA 75 &100.

#### PORTA CPU SOSPESO

- **Modello BIG** Realizzato in lamiera piegata verniciata con polveri epossidiche nel colore Bianco opaco Ral 9016.

Possibilità di regolazione in Altezza da 37,7 a 53, 2 cm e in Larghezza da 7,8 a 22 cm. Peso massimo CPU 15 Kg.

- **Modello A CINGHIA** composto da un meccanismo tenditore completo di cinghia in Nylon colore nero. Sopra al tenditore è montata una piastra metallica che inserirà in una seconda piastra sagomata ne permette lo scorrimento e la rotazione. Entrambe le piastre sono verniciate con polveri epossidiche nel colore Alluminio Ral 9006. Possibilità di regolazione in Altezza da 24 a 50 cm e in Larghezza da 8 a 22,5 cm. Peso massimo CPU 15 Kg.

Tutti i porta CPU sono liberamente agganciabili alla struttura e facilmente spostabili grazie all'utilizzo di 4 clip in Nylon6 FV20% in color Bianco o Antracite montate tramite una coppia di staffe metalliche che ne agevolano il posizionamento.

## TABULA \_SPECIFICHE TECNICHE

### CANALIZZAZIONE

#### VASCONE accumulo CAVI per SCRIVANIE DOPPIE (BENCH) ad ALTEZZA FISSA

Realizzato in Ferrofilo diam. 4 mm verniciato con polveri epossidiche nei colori, Bianco opaco Ral 9016 e Antracite Micalizzato. L'aggancio alla struttura avviene mediante l'utilizzo di 4 clip in Nylon6 FV20% in color Bianco o Antracite montate su appositi sostegni presenti sul vascone.

Disponibili nelle seguenti configurazioni:

- Per piani intermedi L.60 e 80 cm
- Per scrivanie L.140 cm
- Per scrivanie L.160 cm
- Per scrivanie L.180 e 200 cm

#### VASCONE accumulo CAVI per SCRIVANIE SINGOLE

Realizzato in lamiera piegata verniciata con polveri epossidiche nei colori, Bianco opaco Ral 9016 e Antracite Micalizzato. Dotato di tappi di chiusura laterale in Nylon6 FV10% in color Bianco o Antracite, con integrate clip fermacavi. I tappi sono agganciati a cerniere realizzate in Nylon6 FV10% in color Bianco o Antracite che ne permettono il fissaggio alla struttura e la rotazione.

Disponibili nelle seguenti dimensioni:

- Per scrivanie L.80, 100, 120, 140, 160, 180 e 200 cm

#### VASCONE accumulo CAVI per SCRIVANIE DOPPIE (BENCH) ad ALTEZZA REGOLABILE

Composto da una vasca realizzata in lamiera piegata sezione 130x80 mm collegata alle gambe tramite due Montanti verticali realizzati in tubolare di metallo sezione diam. 35 mm verniciata con polveri epossidiche nei colori, Bianco opaco Ral 9016 e Antracite Micalizzato. Il Vascone è predisposto all'innesto della struttura porta screen frontali per Tabula Bench ad altezza regolabile.

Disponibili nelle seguenti dimensioni:

- Per scrivanie L.140, 160, 180 e 200 cm

#### VERTEBRA per PASSAGGIO CAVI STANDARD

Realizzata in Policarbonato trasparente lunghezza totale 81cm.

Base diam.16,5 cm realizzata in metallo verniciato color Alluminio.

#### VERTEBRA per PASSAGGIO CAVI PLUS

Passacavi verticale a spirale realizzato in Metallo e setole in Nylon colore nero. Base ed aggancio realizzati in zama finitura Cromo Lucido.

#### TOP ACCESS

Realizzati in Alluminio, con plastiche di chiusura laterale in ABS, sono disponibili in finitura Verniciato Bianco o Brill. L'apertura del coperchio è disponibile nella versione Frontale con integrato sistema di chiusura Soft oppure nella versione DOPPIA (apertura da entrambi i lati) grazie a particolari cerniere in policarbonato. Per il supporto delle multiprese possono essere utilizzate apposite vaschette portacavi (optional) oppure i vasconi per accumulo cavi (per scrivanie doppie e singole). Disponibili nelle seguenti misure: L.26,4 o 45,4 x P.12,5 cm.

Tutti i materiali utilizzati sono conformi alle norme UNI EN e sono certificati per il 90% CARB 2 (relativamente all'emissione di formaldeide).

## TABULA \_TECHNICAL SPECIFICATIONS

**DESKS, MEETING TABLES, DESK RETURNS** formed of:

### LAMINATE TOPS

Tops made from 18 mm-thick particleboard, with a density of about 650 kg/m<sup>3</sup>, covered on both sides by a layer of melamine-coated paper (120 g/m<sup>2</sup>), with a scratch-proof and anti-reflective surface, in the following finishes: **Ivory, Cement Render Effect, Dark Brown Elm, Cream Elm, Black Walnut, Vulcano, Graphite, Warm Grey, Moss Grey and Petrol Green.**  
The panels have high bending and tensile strength, and excellent resistance to ageing and stains.  
The edges are made from an ABS compound, fixed with polyurethane glue and rounded.  
The standard panels used are classified for reaction to fire in Class 2.

Each top is supplied with **QUICK FIX** technology (system that allows for positioning the tops without using hardware and tools) **already mounted** and - on the basis of the client's requirements - it is fitted with the **FIXED** or **SLIDING TOP** attachment system.  
Both systems are formed of four (4) slides and two (2) handles made from Nylon 6 + 15% GF (Aluminium colour).

### FIXED METAL LEGS

**(Type C Reference Standard EN 527-1:2011)**

Metal legs, in five sizes (depth: 60, 80, 90, 125 and 165 cm).  
The legs (D.60, 80 and 90 cm) are composed of an upper horizontal crosspiece in rectangular tubular steel (60x40xD.2 mm) and a vertical upright in square tubular steel (60x60xD.2 mm), connected to the crosspiece by a round tubular steel piece (diameter 45xD.2 mm), which separates it by 10 mm, and by a rectangular tubular steel foot (80x15xD.2 mm).  
The feet and tips come with adjustable levellers with a range of 20 mm (for perfect levelling on floor).

The legs (D.125 and 165 cm) are composed of an upper horizontal crosspiece in rectangular tubular steel (60x40xD.2 mm) and two vertical uprights in square tubular steel (60x60xD.2 mm), connected to the crosspiece by a round tubular steel piece (diameter 45xD.2 mm), which separates them by 10 mm. All leg types are available in epoxy powder-coated finishes of Ral 9016 matte White and Anthracite Mica. The crosspiece comes with two or four pre-mounted housing seats (two for the 60, 80 and 90 deep legs and four for the 125 and 165 deep legs) in Nylon 6 + 20% GF (colours: White or Anthracite) to fix the crosspieces in place. The legs are fitted with caps and tips, both made from moulded ABS (colours: White or Anthracite).  
The feet and tips come with adjustable levellers with a range of 20 mm (for perfect levelling on floor). The middle legs are obtained during assembly by applying a special metal and Nylon 6 + 20% GF co-mould (Aluminium colour), inserted into the housing seats on the crossbeam.

### METAL LEGS WITH TWO-STEP HEIGHT ADJUSTMENT (65 - 85 CM) - WITH BUTTON (trade name "ONE CLICK")

**(Type B Reference Standard EN 527-1:2011)**

Metal legs, in five sizes (depth: 60, 80, 90, 125 and 165 cm). The legs (D.60, 80 and 90 cm) are composed of a horizontal crosspiece in rectangular tubular steel (60x40xD.2 mm) and a vertical upright in round tubular steel (diameter 45xD.2 mm). Both the steps and the adjustment scale with 20-mm pitch (obtained by embossing moulding) are mounted on the upright. Adjustment is obtained by means of a second external vertical upright in rectangular tubular steel (100x60xD.2 mm) where the single-step button, made from Nylon 6 + 20% GF (colours: White or Anthracite) is mounted, allowing for adjustment from a minimum of 65 cm to a maximum of 85 cm at 2 cm steps. The external upright comes with a foot made from rectangular tubular steel (80x15xD.2 mm).

The legs (D.125 and 165 cm) are composed of two horizontal crosspieces in rectangular tubular steel (60x40xD.2 mm) and two vertical inner uprights in round tubular steel (diameter 45xD.2 mm).  
Both the steps and the adjustment scale with 20-mm pitch are mounted on the uprights (obtained by embossing moulding). Adjustment is obtained by means of a second pair of external vertical uprights in rectangular tubular steel (100x60xD.2 mm) where the single-step button, made from Nylon 6 + 20% GF (colours: White or Anthracite) is mounted, allowing for adjustment from a minimum of 65 cm to a maximum of 85 cm at 2 cm steps.  
The two external uprights are connected by a foot made from rectangular tubular steel (80x15xD.2 mm) This enables independent height adjustment of each of the face-to-face tops.

All leg types are available in epoxy powder-coated finishes of Ral 9016 matte White or Anthracite Mica. The crosspiece comes with two or four pre-mounted housing seats (two for the 600, 800 and 900 deep legs and four for the 1250 and 1650 deep legs) in Nylon 6 +20% GF (colours: White or Anthracite) to fix the crosspieces in place. The legs are fitted with caps and tips, both made from moulded ABS (colours: White or Anthracite).  
The feet come with adjustable levellers with a range of 20 mm (for perfect levelling on floor).  
The middle legs are obtained during assembly by applying a special metal and Nylon 6 + 20% GF co-mould (Aluminium colour), inserted into the housing seats on the crossbeam.

### METAL LEGS WITH TWO-STEP HEIGHT ADJUSTMENT (65 - 85 CM) - ELECTRICAL

**(Type A Reference Standard EN 527-1:2011)**

Metal legs, in five sizes (depth: 60, 80, 90, 125 and 165 cm).  
The legs (D.60, 80 and 90 cm) are composed of a horizontal crosspiece in rectangular tubular steel (60x40xD.2 mm), a foot made from rectangular tubular steel (80x15xD.2 mm) and an electrically actuated lifting column available in two versions (see specifications at end of section).  
The legs (D.125 and 165 cm) are composed of two horizontal crosspieces in rectangular tubular steel (60x40xD.2 mm) and two vertical inner uprights in round tubular steel (diameter 45xD.2 mm) and a pair of electrically actuated lifting columns available in two versions (see specifications at end of section). The two columns are connected by a foot made from rectangular tubular steel (80x15xD.2 mm) This enables independent height adjustment of each of the face-to-face tops.  
All leg types are available in epoxy powder-coated finish (**Ral 9016 matte White ONLY**). The crosspiece comes with two or four pre-mounted housing seats (two for the 600, 800 and 900 deep legs and four for the 1250 and 1650 deep legs) in White Nylon 6 +20% GF to fix the crosspieces in place.  
The legs are fitted with caps and tips, both made from White moulded ABS. The feet come with adjustable levellers with a range of 20 mm (for perfect levelling on floor).

**PLEASE NOTE:** NO MIDDLE LEG IS INCLUDED in the electrical column version.

## SPECIFICATIONS OF ELECTRICALLY ACTUATED SYSTEMS

### LINAK ADJUSTMENT SYSTEMS

System composed of two, three-stage rectangular columns (100x60 mm) complete with anti-collision sensor to minimise any damage to the table both when rising and when lowering. Synchronised movement of middle profile. Invisible inner sliding bearings so movement is smooth and silent.  
Control box with electronic overload protection with soft start-stop function, stand-by power consumption (0.1 W), interchangeable power cable.  
Control commands available in two versions:

- **BASIC**\_Control panel fitted with up and down buttons only, available in White and Black
- **PLUS**\_Control panel fitted with up and down buttons, LED display for height readout and three memory position buttons, available in White and Black. The display switches off when not in use thereby saving power.

All parts are made from PVC-free materials for a more ecological and environmentally friendly system.

The Linak system has PROVISION for the following connections:

**Bluetooth** (also after installation) so all system functions can be controlled from the PC or by a specific App. No installation required, you just need to insert the unit into the control box port to connect devices.

**IoT card** enabling all the Bluetooth functions to connect the Desk to IoT technology.

## TABULA \_TECHNICAL SPECIFICATIONS

### OKIN ADJUSTMENT SYSTEMS

System composed of two, three-stage rectangular columns (80x62 mm) complete with anti-collision sensor to minimise any damage to the table both when rising and when lowering. Synchronised movement of middle profile. Invisible inner sliding bearings so movement is smooth and silent.  
Control box with electronic overload protection with soft start-stop function, stand-by power consumption (0.3 W), interchangeable power cable.  
Control commands available in two versions:

- **BASIC**\_Control panel fitted with up and down buttons only, available in Black
- **PLUS**\_Control panel fitted with up and down buttons, LED display for height readout and four memory position buttons, available in Black. The display switches off when not in use thereby saving power.

### STRUCTURAL CROSSPIECES

These are made from rectangular tubular steel (25x40xD.2 mm), available in epoxy powder-coated finishes of Ral 9016 matte White and Anthracite Mica. Each crosspiece is fitted with a pair of special slides made from Nylon 6 + 20% GF (colours: White or Anthracite) for coupling tops with **QUICK-FIX technology** (system that allows for positioning the tops without using hardware and tools) and - on the basis of the client's requirements - it is fitted with the **FIXED** or **SLIDING TOP** attachment system. The ends of all the crosspieces come with ABS end caps (colours: White or Anthracite), removable if middle legs are used.  
The extension crosspieces are obtained using the same crosspieces as the desks, with the addition of a coupling kit made from Nylon 6 + 20% GF (colours: White or Anthracite), composed of two brackets and an adjustable spacer for the depths of the top (600 mm and 800 mm deep).

**STRUCTURAL RETURN** formed of:

**(Can only be used with FIXED height desks)**

### STORAGE UNITS

Shell made from 18 mm-thick particleboard, coated on both sides in scratch-proof laminate (colours: **Ivory** or **Penelope Clay**, Matching Door, Drawer Fronts and Backs made from 18 mm-thick particleboard, coated on both sides in scratch-proof laminate, with the following finishes: Ivory, Cement Render Effect, Dark Brown Elm, Cream Elm, Black Walnut, Vulcano, Graphite, Warm Grey, Moss Grey and Petrol Green.

Complete with lock that has a removable barrel and duplicate keys with folding ABS safety key cover grip.  
Zamak handle available in Ral 9016 matte White and Anthracite Mica colours. Drawer unit fitted with 12 mm high inner drawers, coated in PVC (in Penelope grey). Concealed Quadro metal runners (ball slides) with soft closing mechanism. Simultaneous locking of all drawers.

### FINISH SET

Made from 18 mm-thick particleboard, coated on both sides in scratch-proof laminate, with the following colours: Ivory, Cement Render Effect, Dark Brown Elm, Cream Elm, Black Walnut, Vulcano, Graphite, Warm Grey, Moss Grey and Petrol Green. Base fitted with black adjustable levellers.

### CONNECTION BRACKET FOR DESKS

The bracket is available for 80, 90, 125 and 165 cm deep tops, and is composed of a horizontal crosspiece in rectangular tubular steel (60x40xD.2 mm) and two spacers made from moulded ABS (colours: White or Anthracite). All bracket types are available in epoxy powder-coated finishes of Ral 9016 matte White and Anthracite Mica. The crosspiece comes with two or four pre-mounted housing seats (two for the 80 and 90 cm deep legs and four for the 125 and 165 cm deep legs) in Nylon 6 + 20% GF (colours: White or Anthracite) to fix the crosspieces in place.  
The brackets are fitted with caps made from moulded ABS (colours: White or Anthracite).

## VELASCA

### VELASCA PROFILE

Composed of extruded profile in aluminium alloy (EN AW-6060), with epoxy powder-coated finishes of Ral 9016 matte White and Anthracite Mica.  
The profile is coupled to the structure by means of two brackets made from Nylon 6 + 20% GF (colours: White or Anthracite).  
The Profile is fitted with caps made from moulded ABS (colours: White or Anthracite).

### FRONT SCREENS FOR VELASCA

available in the following materials:  
- **FABRIC** (colours: Orange Melange, Green, Sky Blue and Sand, with variable density sound-absorbent mat obtained by thermoforming the material with aluminium mould. This technique makes it possible to obtain an item that can absorb a larger spectrum of wavelengths.  
The panels are inserted into the Velasca track by two ABS clips and are easy to position.  
Available in Semi-circle (L.76 x H.39 cm) and Rectangle (77, 117, 137 and 157 x H.39 cm) configurations.  
- **LAMINATE** made from 18 mm-thick particleboard, with a density of about 650 kg/m<sup>3</sup>, covered on both sides by a layer of melamine-coated paper (120 g/m<sup>2</sup>), with a scratch-proof and anti-reflective surface, in the following finishes: Ivory, Cement Render Effect, Dark Brown Elm, Cream Elm, Black Walnut, Vulcano, Graphite, Warm Grey, Moss Grey and Petrol Green.  
The panels have high bending and tensile strength, and excellent resistance to ageing and stains.  
The edges are made from an ABS compound, fixed with polyurethane glue and rounded.  
The standard panels used are classified for reaction to fire in Class 2.  
The panels are inserted into the Velasca track by two ABS clips and are easy to position. Available in the RECTANGLE configuration.  
- **GLASS** made from 8-mm thick etched and tempered float glass. The panels are inserted into the Velasca track by two ABS clips and are easy to position. Available in the RECTANGLE configuration

### VELASCA SHELF

Composed of extruded profile in aluminium alloy (EN AW-6060), with epoxy powder-coated finishes of Ral 9016 matte White and Anthracite Mica.  
The shelves can be freely attached to the Velasca track and are easy to move and reposition.

### VELASCA ACCESSORIES

Composed of extruded profile in aluminium alloy (EN AW-6060), with epoxy powder-coated finishes of Ral 9016 matte White and Anthracite Mica.  
The accessories can be freely attached to the Velasca track and are easy to move and reposition.

Available as follows:

- Pen holder mounting rack (L.10 x D.14 cm), complete with clear plastic pen holder
- Thermal mug holder (L.10 x D.14 cm), complete with thermal mug
- Mobile phone holder (L.10 x D.14 cm)
- Power socket holder (L.25 x D.14 cm) complete with power strip with three combined Schuko-Italy sockets



## TABULA \_TECHNICAL SPECIFICATIONS

### ACCESSORIES

#### FRONT SCREENS – TO BE USED WITH FIXED and HEIGHT-ADJUSTABLE DESKS - and WITH FIXED HEIGHT BENCH

Available in the following materials:

- **FABRIC** (colours: Orange Melange, Green, Sky Blue and Sand, with variable density sound-absorbent mat obtained by thermoforming the material with aluminium mould. This technique makes it possible to obtain an item that can absorb a larger spectrum of wavelengths. Available in Semi-circle (L.76 x H.39 cm) and Rectangle (77, 117, 137 and 157 x H.39 cm) configurations.
  - **LAMINATE** made from 18 mm-thick particleboard, with a density of about 650 kg/m<sup>3</sup>, covered on both sides by a layer of melamine-coated paper (120 g/m<sup>2</sup>), with a scratch-proof and anti-reflective surface, in the following finishes: Ivory, Cement Render Effect, Dark Brown Elm, Cream Elm, Black Walnut, Vulcano, Graphite, Warm Grey, Moss Grey and Petrol Green. The panels have high bending and tensile strength, and excellent resistance to ageing and stains. The edges are made from an ABS compound, fixed with polyurethane glue and rounded. The standard panels used are classified for reaction to fire in Class 2. Available in the RECTANGLE configuration
  - **GLASS** made from 8-mm thick etched and tempered float glass. Available in the RECTANGLE configuration
- All the screens are coupled to the structure by means of two brackets made from Nylon 6 + 20% GF (colours: White or Anthracite), complete with two clips made from Nylon 6 + 20% GF (colours: White or Anthracite).

**SIDE SCREEN** available in the following materials:

- **FABRIC** (colours: Orange Melange, Green, Sky Blue and Sand, with variable density sound-absorbent mat obtained by thermoforming the material with aluminium mould. This technique makes it possible to obtain an item that can absorb a larger spectrum of wavelengths. Available in the SHAPED configuration (L.73 x H.39 cm)
- **LAMINATE** made from 18 mm-thick particleboard, with a density of about 650 kg/m<sup>3</sup>, covered on both sides by a layer of melamine-coated paper (120 g/m<sup>2</sup>), with a scratch-proof and anti-reflective surface, in the following finishes: Ivory, Cement Render Effect, Dark Brown Elm, Cream Elm, Black Walnut, Vulcano, Graphite, Warm Grey, Moss Grey and Petrol Green. The panels have high bending and tensile strength, and excellent resistance to ageing and stains. The edges are made from an ABS compound, fixed with polyurethane glue and rounded. The standard panels used are classified for reaction to fire in Class 2. Available in the SHAPED configuration (L.73 x H.39 cm)

The side screens can be attached to the top using a kit composed of a holding bracket and a metal clip (available colours: Ral 9016 matte White and Anthracite Mica) or by resting it on the top by means of a metal plate (available colours: Ral 9016 matte White and Anthracite Mica). The second option means the side screen can be freely positioned.

#### FRONT SCREENS – TO BE USED WITH HEIGHT-ADJUSTABLE BENCH ONLY (ONE-CLICK AND ELECTRIC)

Available in the following materials:

- **FABRIC** (colours: **Orange Melange, Green, Sky Blue and Sand** (inner mat with square pattern stitching). These are available in Rectangular configuration in sizes L.128, 148, 168 and 188 x H.105 cm. Bearing structure composed of two vertical uprights in round tubular steel (diameter 35xD.2 mm) and by a horizontal crosspiece in square tubular steel (30x30xD.2 mm) with epoxy powder-coated finishes of Ral 9016 matte White and Anthracite Mica. The structure comes with caps made from moulded ABS (colours: White or Anthracite).
  - **LAMINATE** made from 18 mm-thick particleboard, with a density of about 650 kg/m<sup>3</sup>, covered on both sides by a layer of melamine-coated paper (120 g/m<sup>2</sup>), with a scratch-proof and anti-reflective surface, in the following finishes: **Ivory, Cement Render Effect, Dark Brown Elm, Cream Elm, Black Walnut, Vulcano, Graphite, Warm Grey, Moss Grey and Petrol Green**. The panels have high bending and tensile strength, and excellent resistance to ageing and stains. The edges are made from an ABS compound, fixed with polyurethane glue and rounded. The standard panels used are classified for reaction to fire in Class 2. These are available in Rectangular configuration in sizes L.128, 148, 168 and 188 x H.105 cm. Bearing structure composed of two vertical uprights in round tubular steel (diameter 35xD.2 mm) with epoxy powder-coated finishes of Ral 9016 matte White and Anthracite Mica. The structure comes with caps made from moulded ABS (colours: White or Anthracite).
- PLEASE NOTE:** for mounting this type of screen it is obligatory to also purchase the CABLE MANAGEMENT TRAY for TABULA HEIGHT-ADJUSTABLE BENCH.

#### METAL SUSPENDED STORAGE UNITS

Made from bent and welded sheet metal (8/10), available with epoxy powder-coated finishes of Ral 9016 matte White and Anthracite Mica. Inner Metal drawers mounted on concealed Quadro metal runners (ball slides) with soft closing mechanism. Lock supplied standard on top drawer, complete with removable barrel and duplicate keys with folding ABS safety key cover grip. Side handled integrated into drawer front.

All units can be attached to the structure and are easy to move thanks to four clips in Nylon 6 + 20% GF (colours: White or Anthracite) mounted on the top of the unit by a pair of metal brackets to facilitate positioning.

The units are available in the following configurations:

- Single drawer with lock - L.32 x D.50 x H.10 cm
  - Two drawers (top drawer with lock) - L.32 x D.50 x H.20 cm
  - Single drawer with lock + compartment - L.32 x D.50 x H.40 cm
  - Two drawers (top drawer with lock) + compartment - L.32 x D.50 x H.40 cm
- P.S.: Compartment size - L.32 x D.50 x H.30 cm

#### MODESTY PANEL

Made from 18 mm-thick particleboard, with a density of about 650 kg/m<sup>3</sup>, covered on both sides by a layer of melamine-coated paper (120 g/m<sup>2</sup>), with a scratch-proof and anti-reflective surface, in the following finishes: Ivory, Vulcano, Cement Render Effect, Dark Brown Elm, Cream Elm, Black Walnut, Vulcano, Graphite, Warm Grey, Moss Grey and Petrol Green.

The panels have high bending and tensile strength, and excellent resistance to ageing and stains.

The edges are made from an ABS compound, fixed with polyurethane glue and rounded.

The standard panels used are classified for reaction to fire in Class 2.

The panels can be attached to the structure using a pair of metal brackets (3 mm thick), available in epoxy powder-coated finishes of Ral 9016 matte White and Anthracite Mica. A clip in Nylon 6 + 20% GF (colours: White or Anthracite) is mounted on each bracket.

#### DESK MOUNT MONITOR ARM

Made from die-cast aluminium painted White or Black, with strap-on monitor balancing that supports monitors of 0 to 9 kg. Wheel balance adjustment without the use of tools. 360° rotation lockable at 180° (+90°/-90°). Clip-on monitor attachment plate, 360° rotation and VESA mount 75 & 100.

#### SUSPENDED CPU HOLDER

- **BIG model** Made from sheet metal, with epoxy powder-coated finish in Ral 9016 matte White. Height adjustment from 37.7 to 53.2 cm.

Width adjustment from 7.8 to 22 cm. Maximum CPU weight - 15 Kg.

- **STRAP-ON** model composed of a tensioning mechanism complete with black Nylon strap. A metal plate is mounted above the tensioning mechanism. This is inserted into a second, shaped plate for sliding and rotation. Both plates have an epoxy powder-coated finish in Ral 9006 Aluminium.

## TABULA \_TECHNICAL SPECIFICATIONS

Height adjustment from 24 to 50 cm. Width adjustment from 8 to 22.5 cm. Maximum CPU weight - 15 Kg.

All CPU holders can be attached to the structure and are easy to move thanks to four clips in Nylon 6 + 20% GF (colours: White or Anthracite) mounted by a pair of metal brackets to facilitate positioning.

### CABLE DUCTING

#### CABLE management TRAY for FIXED-HEIGHT BACK TO BACK DESKS (BENCH)

Made from wire (diameter 4 mm) in epoxy powder-coated finishes of Ral 9016 matte White and Anthracite Mica. Four clips in Nylon 6 + 20% GF (colours: White or Anthracite) mounted on the brackets of the tray are used for attachment to structure.

Available in the following configurations:

- For middle tops: L.60 and 80cm
- For desks: L 140 cm
- For desks: L 160 cm
- For desks: L.180 and 200cm

#### CABLE management TRAY for SINGLE DESKS

Made from bent sheet metal in epoxy powder-coated finishes of Ral 9016 matte White and Anthracite Mica.

It is fitted with end caps in Nylon 6 + 10% GF (colours: White or Anthracite), with integrated cable clips.

The caps are attached by hinges made from Nylon 6 + 10% GF (colours: White or Anthracite) so they can be fixed to the structure and can be rotated.

Available in the following sizes:

- For desks: L.80, 100, 120, 140, 160, 180 and 200 cm

#### CABLE management TRAY for HEIGHT-ADJUSTABLE BACK TO BACK DESKS (BENCH)

Composed of a tray made from bent sheet metal (130x80 mm) attached to the legs by means of two vertical uprights in round tubular steel (diameter 35 mm) with epoxy powder-coated finishes of Ral 9016 matte White and Anthracite Mica.

The tray is set up to be fit into the front screen holder for height-adjustable Tabula Bench.

Available in the following sizes:

- For desks: L.140, 160, 180 and 200 cm

#### STANDARD VERTEBRAE for CABLE MANAGEMENT

Made from clear Polycarbonate with total length of 81 cm.

Diameter of base 16,5 cm, made from Aluminium coated metal.

#### PLUS VERTEBRAE for CABLE MANAGEMENT

Vertical spine cable management system made from Metal and Nylon bristles (black).

Base and attachment made from Zamak with Polished Chrome finish.

#### TOP ACCESS

Made from Aluminium, with ABS end caps, they come in White or Brill finish. The lid opening comes in the Front version, with integrated soft-closing mechanism, or in the DOUBLE version (can be opened from either side), thanks to special polycarbonate hinges.

The power strips can be stored in specific cable management trays (optional) or in the cable management trays (for back to back and single desks).

Available in the following sizes: L.26.4 or 45.4 x D.12.5.

All materials used comply with UNI EN standards, and 90% of its production is certified to CARB 2 (formaldehyde emissions).



## TABULA \_SPÉCIFICATIONS TECHNIQUES

### ACCESSOIRES

#### ÉCRANS PRIVATIFS FRONTAUX - UTILISABLES AVEC BUREAUX À HAUTEUR FIXE ET RÉGLABLE et AVEC BENCH à HAUTEUR FIXE

Disponibles dans les matériaux suivants :

- **TISSU** dans les couleurs Mélange Orange, Vert, Bleu et Sable, avec du matériau acoustique à densité variable obtenu par le thermoformage avec un moule en aluminium. Cette technique permet d'obtenir un produit capable d'absorber un plus large spectre de longueurs d'onde. Disponibles dans les versions Demi-cercle (L.76xH.39 cm) et Rectangulaire (77, 117, 137 et 157xH.39 cm).
- **MÉLAMINÉ** : réalisés en bois aggloméré de 18 mm d'épaisseur, avec une densité d'environ 650 kg/m<sup>3</sup> ; revêtement en mélaminé sur les deux côtés (grammage papier : 120 g/m<sup>2</sup>) ; traitement anti-rayures et antireflet. Finitions disponibles : Ivoire, Béton Taloché, Orme Foncé, Orme Crème, Noyer Noir, Vulcano, Graphite, Chanvre, Vison et Vert Pétrole. Les panneaux ont une bonne résistance à la flexion et à la traction et une excellente résistance au vieillissement et aux taches. Les chants sur le pourtour sont en ABS, collés avec de la colle polyuréthane et arrondis. Les panneaux de série sont classés en catégorie 2 pour ce qui concerne la réaction au feu. Disponibles dans la version RECTANGULAIRE.
- **VERRE** : réalisés en verre float acidé et trempé de 8 mm d'épaisseur. Disponibles dans la version RECTANGULAIRE. Tous les écrans privatifs sont fixés à la structure au moyen de deux brides en Nylon 6 renforcé fibre de verre (20 %) de couleur Blanc ou Anthracite, avec deux pinces en Nylon 6 renforcé fibre de verre (20 %) de couleur Blanc ou Anthracite.

**ÉCRAN PRIVATIF LATÉRAL disponibles** dans les matériaux suivants :

- **TISSU** dans les couleurs Mélange Orange, Vert, Bleu et Sable, avec du matériau acoustique à densité variable obtenu par le thermoformage avec un moule en aluminium. Cette technique permet d'obtenir un produit capable d'absorber un plus large spectre de longueurs d'onde. Disponible dans la version GALBÉ L.73xH.39 cm
- **MÉLAMINÉ** : réalisé en bois aggloméré de 18 mm d'épaisseur, avec une densité d'environ 650 kg/m<sup>3</sup> ; revêtement en mélaminé sur les deux côtés (grammage papier : 120 g/m<sup>2</sup>) ; traitement anti-rayures et antireflet. Finitions disponibles : Ivoire, Béton Taloché, Orme Foncé, Orme Crème, Noyer Noir, Vulcano, Graphite, Chanvre, Vison et Vert Pétrole. Les panneaux ont une bonne résistance à la flexion et à la traction et une excellente résistance au vieillissement et aux taches. Les chants sur le pourtour sont en ABS, collés avec de la colle polyuréthane et arrondis. Les panneaux de série sont classés en catégorie 2 pour ce qui concerne la réaction au feu. Disponible dans la version GALBÉ L.73xH.39 cm

Les écrans privatifs latéraux peuvent être fixés au plateau à l'aide d'un kit composé d'un socle et d'une pince métallique disponibles en Blanc RAL9016 ou Anthracite Micacé ou bien fixés au plateau à l'aide d'une plaque de métal disponible en Blanc RAL9016 ou Anthracite Micacé. Cette dernière option permet de positionner librement l'écran privatif latéral.

#### ÉCRANS PRIVATIFS FRONTAUX - UTILISABLES UNIQUEMENT avec BENCH à HAUTEUR RÉGLABLE (ONECLICK OU ÉLECTRIQUE)

Disponibles dans les matériaux suivants :

- **TISSU** dans les couleurs **Mélange Orange, Vert, Bleu et Sable** avec rembourrage avec points de piqûre à motif « carré ». Disponibles dans la version Rectangulaire dans les dimensions L.128, 148, 168 et 188 x H.105 cm Structure porteuse composée de deux tubes métalliques verticaux de section ronde diam. 35xép.2 mm et une traverse horizontale en métal tubulaire de section 30x20xép.2 mm peinte avec des poudres époxy de couleur Blanc mat RAL9016 et Anthracite Micacé. La structure est équipée de bouchons en ABS moulé de couleur Blanc ou Anthracite.
  - **MÉLAMINÉ** : réalisés en bois aggloméré de 18 mm d'épaisseur, avec une densité d'environ 650 kg/m<sup>3</sup> ; revêtement en mélaminé sur les deux côtés (grammage papier : 120 g/m<sup>2</sup>) ; traitement anti-rayures et antireflet. Finitions disponibles : **Ivoire, Béton Taloché, Orme Foncé, Orme Crème, Noyer Noir, Vulcano, Graphite, Chanvre, Vison et Vert Pétrole.** Les panneaux ont une bonne résistance à la flexion et à la traction et une excellente résistance au vieillissement et aux taches. Les chants sur le pourtour sont en ABS, collés avec de la colle polyuréthane et arrondis. Les panneaux de série sont classés en catégorie 2 pour ce qui concerne la réaction au feu. Disponibles dans la version Rectangulaire dans les dimensions L.128, 148, 168 et 188 x H.105 cm. Structure porteuse composée de deux tubes métalliques verticaux de section Ronde diam. 35xép.2 mm peinte avec des poudres époxy de couleur Blanc mat RAL9016 et Anthracite Micacé. La structure est équipée de bouchons en ABS moulé de couleur Blanc ou Anthracite.
- ATTENTION** : pour le montage de ce type d'écran privatif il faut également acheter le CHEMIN DE CÂBLES POUR TABULA BENCH À HAUTEUR RÉGLABLE.

#### ÉLÉMENTS MÉTALLIQUES SUSPENDUS

- Réalisés en tôle 8/10 pliée et soudée, peints avec des poudres époxy dans les couleurs Blanc mat RAL9016 ou Anthracite Micacé. Tirons internes en métal avec coulisses à billes Quadro invisibles à fermeture amortie. Serrure fournie de série sur le premier tiroir, avec cylindre amovible et deux clés avec couvre-clé de protection pliant en ABS. Poignée latérale intégrée dans la façade du tiroir. Tous les éléments peuvent être fixés librement à la structure et sont faciles à déplacer grâce aux 4 clips en Nylon 6 renforcé fibre de verre (20 %) de couleur Blanc ou Anthracite fixés sur le top de l'élément à l'aide d'une paire de brides métalliques qui en facilitent le positionnement. Les éléments sont disponibles dans les configurations suivantes :
- Un tiroir avec serrure L.32xP.50x **H.10 cm**
  - Deux tiroirs (tiroir du haut avec serrure) L.32xP.50x**H.20 cm**
  - Un tiroir avec serrure + niche L.32xP.50x**H.40 cm**
  - Deux tiroirs (tiroir du haut avec serrure) + niche L.32xP.50x**H.40 cm**
- P.S. : dimensions niche L.32xP.50xH.30 cm

#### VOILE DE FOND

Réalisé en bois aggloméré de 18 mm d'épaisseur, avec une densité d'environ 650 kg/m<sup>3</sup> ; revêtement en mélaminé sur les deux côtés (grammage papier : 120 g/m<sup>2</sup>) ; traitement anti-rayures et antireflet. Finitions disponibles : Ivoire, Vulcano, Béton Taloché, Orme Foncé, Orme Crème, Noyer Noir, Vulcano, Graphite, Chanvre, Vison et Vert Pétrole. Les panneaux ont une bonne résistance à la flexion et à la traction et une excellente résistance au vieillissement et aux taches. Les chants sur le pourtour sont en ABS, collés avec de la colle polyuréthane et arrondis. Les panneaux de série sont classés en catégorie 2 pour ce qui concerne la réaction au feu. Les panneaux sont fixés à la structure par une paire de brides métalliques de 3 mm d'épaisseur peintes avec des poudres époxy de couleur Blanc mat RAL9016 et Anthracite Micacé chaque support est muni d'un clip en Nylon 6 renforcé fibre de verre (20 %) de couleur Blanc ou Anthracite.

## TABULA \_SPÉCIFICATIONS TECHNIQUES

### BRAS PORTE-ÉCRAN

Réalisé en aluminium moulé sous pression et peint de couleur Blanc ou Noir, avec système d'équilibrage de l'écran à courroie qui permet l'application d'écrans de 0 à 9 kg. Réglage de l'équilibrage avec la molette, sans utilisation d'aucun outil. Rotation à 360° avec possibilité de bloquer la rotation à 180° (+90°/-90°). Plaque de fixation de l'écran à clip, rotation à 360° et fixation VESA 75 et 100.

### SUPPORT UC SUSPENDU

- **Modèle BIG** réalisé en tôle pliée peinte avec des poudres époxy de couleur Blanc mat RAL9016. Possibilité de réglage en hauteur de 37,7 à 53,2 cm et en largeur de 7,8 à 22 cm. Poids maximum UC : 15 kg.
- **Modèle À SANGLE** composé d'un mécanisme tendeur avec sangle en nylon noir. La plaque métallique installée au-dessus du tendeur, lorsqu'elle est insérée dans une deuxième plaque galbée, en permet le coulisement et la rotation. Les deux plaques sont peintes avec des poudres époxy de couleur Aluminium RAL9006. Possibilité de réglage en hauteur de 24 à 50 cm et en largeur de 8 à 22,5 cm. Poids maximum UC : 15 kg. Tous les supports UC peuvent être fixés librement à la structure et sont faciles à déplacer grâce aux 4 clips en Nylon 6 renforcé fibre de verre (20 %) de couleur Blanc ou Anthracite fixés à l'aide d'une paire de brides métalliques qui en facilitent le positionnement.

### CANALISATION

#### CHEMIN DE CÂBLES pour BUREAUX DOUBLES (BENCH) à HAUTEUR FIXE

Réalisé en fil de fer diam. 4 mm peint avec des poudres époxy, couleur Blanc mat RAL9016 et Anthracite Micacé. Fixation à la structure à l'aide de 4 clips en Nylon 6 renforcé fibre de verre (20 %) de couleur Blanc ou Anthracite montés sur des supports spéciaux sur le chemin de câbles.

Disponibles dans les versions suivantes :

- pour plateaux intermédiaires L.60 et 80cm
- pour bureaux L.140 cm
- pour bureaux L.160 cm
- pour bureaux L.180 et 200cm

#### CHEMIN DE CÂBLES pour BUREAUX SIMPLES

Réalisé en tôle d'acier pliée et peint avec des poudres époxy, couleur Blanc mat RAL9016 et Anthracite Micacé.

Fourni avec bouchons de fermeture latérale en Nylon6 FV10% de couleur Blanc ou Anthracite, avec clips serre-câbles intégrés. Les bouchons sont fixés à des charnières réalisées en Nylon 6 renforcé fibre de verre (10 %) de couleur Blanc ou Anthracite qui permettent la fixation à la structure et la rotation.

Disponibles dans les dimensions suivantes :

- pour bureaux L.80, 100, 120, 140, 160, 180 et 200cm

#### CHEMIN DE CÂBLES pour BUREAUX DOUBLES (BENCH) à HAUTEUR RÉGLABLE

Passage de câbles réalisé en tôle pliée de 130x80mm relié aux pieds par deux montants verticaux en métal tubulaire de diam. 35 mm peint avec des poudres époxy de couleur Blanc mat RAL9016 et Anthracite Micacé.

Le chemin de câble est prévu pour la fixation de la structure porte-écrans privatifs frontaux pour Tabula Bench à hauteur réglable.

Disponibles dans les dimensions suivantes :

- pour bureaux L.140, 160, 180 et 200 cm

#### VERTÈBRE PASSE-CÂBLES, MODÈLE STANDARD

Réalisée en polycarbonate transparent, longueur totale 81 cm.

Base de 16,5 cm de diamètre réalisée en métal peint Aluminium.

#### VERTÈBRE PASSE-CÂBLES, MODÈLE PLUS

Passer-câbles vertical en spirale en métal et poils en nylon noir. Base et élément de fixation réalisés en zamak, finition Chrome Brillant.

#### TOP ACCESS

Réalisés en aluminium ; disponibles dans la finition peint Blanc ou Brill. L'ouverture du couvercle est disponible dans la version Frontale avec système de fermeture Soft-Close intégré ou dans la version DOUBLE (ouverture des deux côtés) grâce à des charnières spéciales en polycarbonate.

Pour le support des multiprises, il est possible d'utiliser des boîtes à câbles appropriées (en option) ou les chemins de câbles (pour bureaux simples et doubles). Disponibles dans les dimensions suivantes : L.26,4 ou 45,4xP.12,5.

**Tous les matériaux employés sont conformes aux normes UNI EN et sont certifiés CARB 2 (concernant l'émission de formaldéhyde) pour 90 % de la production.**

# LUCERNA

DESIGN by PERIN&PARTNERS

LAMPADE PER I SISTEMI OPERATIVI STILO E TABULA

L'illuminazione è un elemento fondamentale nella promozione del benessere delle persone e sta assumendo un ruolo sempre più importante nella società e nella vita di tutti noi.

Un utilizzo consapevole della luce può quindi contribuire a migliorare la concentrazione, la sicurezza e l'efficienza nei luoghi di lavoro.

Nasce da queste riflessioni il progetto **LUCERNA by IVM**.

Lighting is fundamental for the health and well-being of people, and it is playing an increasingly important role in society and in our lives.

By consciously using light we can therefore foster improved concentration, safety and efficiency in the workplace.

This premise sets the scene for the **LUCERNA by IVM** project.

L'éclairage est un élément fondamental dans le domaine du bien-être et joue un rôle de plus en plus important dans la société et la vie de chacun d'entre nous.

Une utilisation consciente de la lumière peut donc contribuer à améliorer la concentration, la sécurité et l'efficacité sur le lieu de travail.

C'est sur ces réflexions que repose le projet **LUCERNA by IVM**.



LUCERNA

LUCERNA by IVM  
LAMPADA a PONTE



HUMAN CENTRIC LIGHTING L'illuminazione al servizio della persona  
L'éclairage centré sur l'humain



## LUCERNA by IVM

Lampada a ponte

La luce delle lampade **LUCERNA** può essere personalizzata in base al proprio ritmo biologico tramite una tastiera integrata sul montante...

...per dare la luce giusta al momento giusto, fornendo al posto di lavoro un'illuminazione artificiale che segue l'andamento della luce naturale e la integra, riservando all'utente la possibilità di adattamento personale.

The light emitted by **LUCERNA** can be customised to suit your biorhythm using a keypad integrated in the upright...

...to deliver the right light at the right time, providing the workstation with dynamic artificial light that changes in intensity according to the time of day, making it possible for users to adjust the light to suit their own needs.

La lumière des lampes **LUCERNA** peut être personnalisée en fonction du rythme biologique individuel par le biais d'un clavier intégré au montant...

...pour donner le bon éclairage au bon moment. Le poste de travail dispose ainsi d'un éclairage artificiel qui suit l'évolution de la lumière naturelle et l'intègre, tout en offrant à l'utilisateur la possibilité de l'adapter à ses exigences personnelles.

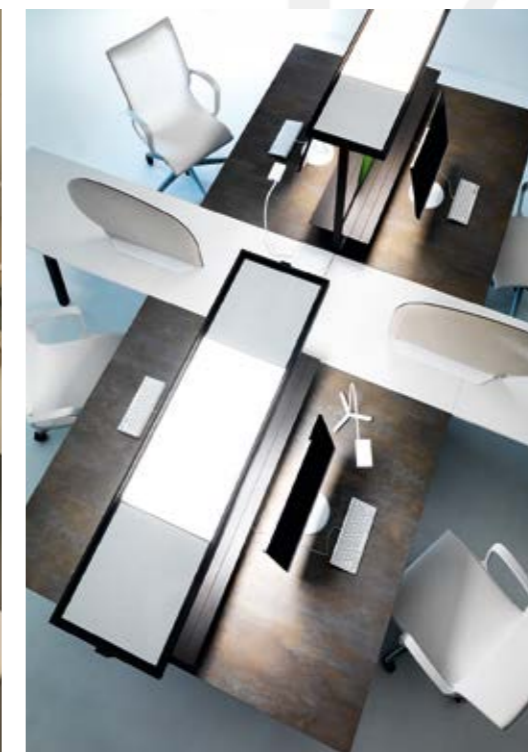





## LUCERNA by IVM

Le lampade LUCERNA sono dotate di led ad alta qualità e di elettronica Goodlight, caratteristiche che garantiscono l'efficacia della luce biologica.

Sono inoltre dotate di:

- tasto di On/Off con funzione di soft start/stop
- regolazione manuale dell'intensità della luce a tonalità calda
- regolazione manuale dell'intensità della luce a tonalità fredda.
- nello standard ci sono 10 passi di regolazione per l'intensità della luce bianco caldo e 10 per la luce bianco freddo con un mix di 100 selezioni possibili

The LUCERNA lights are fitted with high quality LEDs and Goodlight electronics, guaranteeing the effectiveness of this biorhythmic lighting.

They are also fitted with:

- On/Off button with soft start/stop function
- manual adjustment to change light intensity to warm tones
- manual adjustment to change light intensity to cool tones
- the standard version includes 10 light intensity adjustment levels for warm white light and 10 for cool white light, which can be mixed for 100 possible options

Les lampes LUCERNA sont équipées de LED de haute qualité et de composants électroniques Goodlight, garants de l'efficacité de la lumière biologique. Elles sont également équipées des éléments suivants :

- touche On/Off dotée d'une fonction Soft Start/Stop
- réglage manuel de l'intensité de la lumière liée à une tonalité chaude
- réglage manuel de l'intensité de la lumière liée à une tonalité froide.
- la version standard propose 10 pas de réglage pour l'intensité de la lumière en blanc chaud et 10 pas pour la lumière en blanc froid, soit un éventail de 100 sélections possibles

## LUCERNA by IVM

LAMPADA INTEGRATA DOPPIA da TAVOLO





La versione a piantana illumina  
il posto di lavoro da un'altezza  
massima di 195 cm.  
Disponibili con illuminazione  
diretta ed indiretta.

The floor lamp version lights  
the workstation from a maximum  
height of 195 cm.  
Available with direct and  
indirect lighting.

La version sur pied éclaire le  
poste de travail d'une hauteur  
maximale de 195 cm.  
À lumière directe et indirecte.



### LAMPADE CON EFFETTO BIOLOGICO DELLA LUCE

Le lampade integrate nelle postazioni di lavoro illuminano il piano da un'altezza di 80 cm, la versione a piantana da un'altezza massima di 195 cm con la stessa uniformità tra i vari modelli, ed il loro design geometrico è nei colori delle strutture delle scrivanie.  
 L'emissione del flusso luminoso è del tipo diretto ed indiretto.

Le lampade **LUCERNA** sono dotate di led di alta qualità ed elettronica Goodlight che garantiscono l'efficacia della luce biologica ed hanno:

- una regolazione manuale dell'intensità della luce a tonalità calda;
- una regolazione manuale dell'intensità della luce a tonalità fredda;
- numerose variazioni di intensità luminosa; nello standard ci sono 10 passi di regolazione per l'intensità della luce bianco caldo e 10 per la luce bianco freddo con un mix di 100 selezioni possibili.

### BIORHYTHMIC LIGHTING

*The lights integrated into the workstations provide overhead light to the desk from a height of 80 cm. The floor lamp version lights the workstation from a maximum height of 195 cm. The different models provide the same even light and their geometric design comes in the same colours as the desk structures. The luminous flux of LUCERNA is direct and indirect emission.*

*The **LUCERNA** lights are fitted with high quality LEDs and Goodlight electronics, which guarantee the effectiveness of this biorhythmic lighting with:*

- manual adjustment to change light intensity to warm tones;
- manual adjustment to change light intensity to cool tones;
- a range of luminous intensity variations; the standard version includes 10 light intensity adjustment levels for warm white light and 10 for cool white light, which can be mixed for 100 possible options.

### DES LAMPES QUI S'ADAPTENT AU RYTHME BIOLOGIQUE

*Les lampes intégrées dans les postes de travail éclairent le plan de travail d'une hauteur de 80 cm, la version sur pied d'une hauteur maximale de 195 cm avec la même uniformité entre les différents modèles ; quant à leur design géométrique, il s'harmonise avec les couleurs des structures des bureaux. Le flux lumineux émis procure un éclairage direct et indirect.*

*Les lampes **LUCERNA** sont équipées de LED de haute qualité et de composants électroniques Goodlight qui garantissent l'efficacité de la lumière biologique et permettent :*

- un réglage manuel de l'intensité de la lumière liée à une tonalité chaude ;
- un réglage manuel de l'intensité de la lumière liée à une tonalité froide ;
- de nombreuses variations au niveau de l'intensité lumineuse ; la version standard propose 10 pas de réglage pour l'intensité de la lumière en blanc chaud et 10 pas pour la lumière en blanc froid, soit un éventail de 100 sélections possibles.

### CARATTERISTICHE TECNICHE

**Sorgenti:**  
**Flusso luminoso**  
**(massimo totale misurato):** 9381 lm (lumen)  
 illuminazione diretta: 4568 lm (lumen)  
 illuminazione indiretta: 4813 lm (lumen)  
**CCT:** da K 3.000 a K 5.000

**CLASSE ENERGETICA:** AAA

**Dimensioni:**  
 altezza 800 mm sul tavolo - 1950 mm piantana  
 - modello integrabile nei benching, lunghezza come il piano di lavoro x 360 x 37 mm;  
 - modello doppia lampada per per benching 1360 x 360 x 37 mm;  
 - piantana 680 x 360 x 37 (corpo illuminante) 1950 x 360 x 750 (totale ingombro piantana)

**Normativa:** DIN SPEC 67600: 2013-04 describe le misure da adottare per un'illuminazione con efficacia biologica

**Materiali:** alluminio, acciaio, PMMA.  
**Colori:** Bianco e Antracite  
**Design:** Studio Perin & Partners

### TECHNICAL SPECIFICATIONS

**Sources:**  
**Luminous flux**  
**(maximum total measured):** 9381 lm (lumen)  
 direct light: 4568 lm (lumen)  
 indirect light: 4813 lm (lumen)  
**CCT:** from K 3000 to K 5000

**Energy class:** AAA

**Dimensions:**  
 height 800 mm on desktop - 1950 mm floor lamp  
 - integrated benching system model - same length as worktop x 360 x 37 mm;  
 - double lamp model for benching system 1360 x 360 x 37 mm;  
 - floor lamp 680 x 360 x 37 mm (lighting body) 1950 x 360 x 750 (total floor lamp footprint)

**Standard:** DIN SPEC 67600: 2013-04 describes the measures to adopt for effective biorhythmic lighting

**Materials:** aluminium, steel, PMMA.  
**Colours:** White and Anthracite  
**Design:** Studio Perin & Partners

### CARACTÉRISTIQUES TECHNIQUES

**Sources :**  
**Flux lumineux**  
**(quantité totale maximale mesurée) :** 9381 lm (lumen)  
 éclairage direct : 4568 lm (lumen)  
 éclairage indirect : 4813 lm (lumen)  
**TCC :** de 3000 K à 5000 K

**Classe énergétique :** AAA

**Dimensions :**  
 hauteur 800 mm au-dessus de la table - 1950 mm sur pied  
 - modèle à intégrer dans le bench, longueur modulée sur le plan de travail x 360 x 37 mm ;  
 - modèle lampe double pour bureau bench 1360 x 360 x 37 mm ;  
 - pied : 680 x 360 x 37 mm (corps lumineux) 1950 x 360 x 750 (encombrement total du pied)

**Règlementation :** la norme DIN SPEC 67600: 2013-04 décrit les mesures à prendre pour un éclairage biologique efficace

**Matériaux :** aluminium, acier, PMMA.  
**Couleurs :** Blanc et anthracite  
**Design :** Studio Perin & Partners

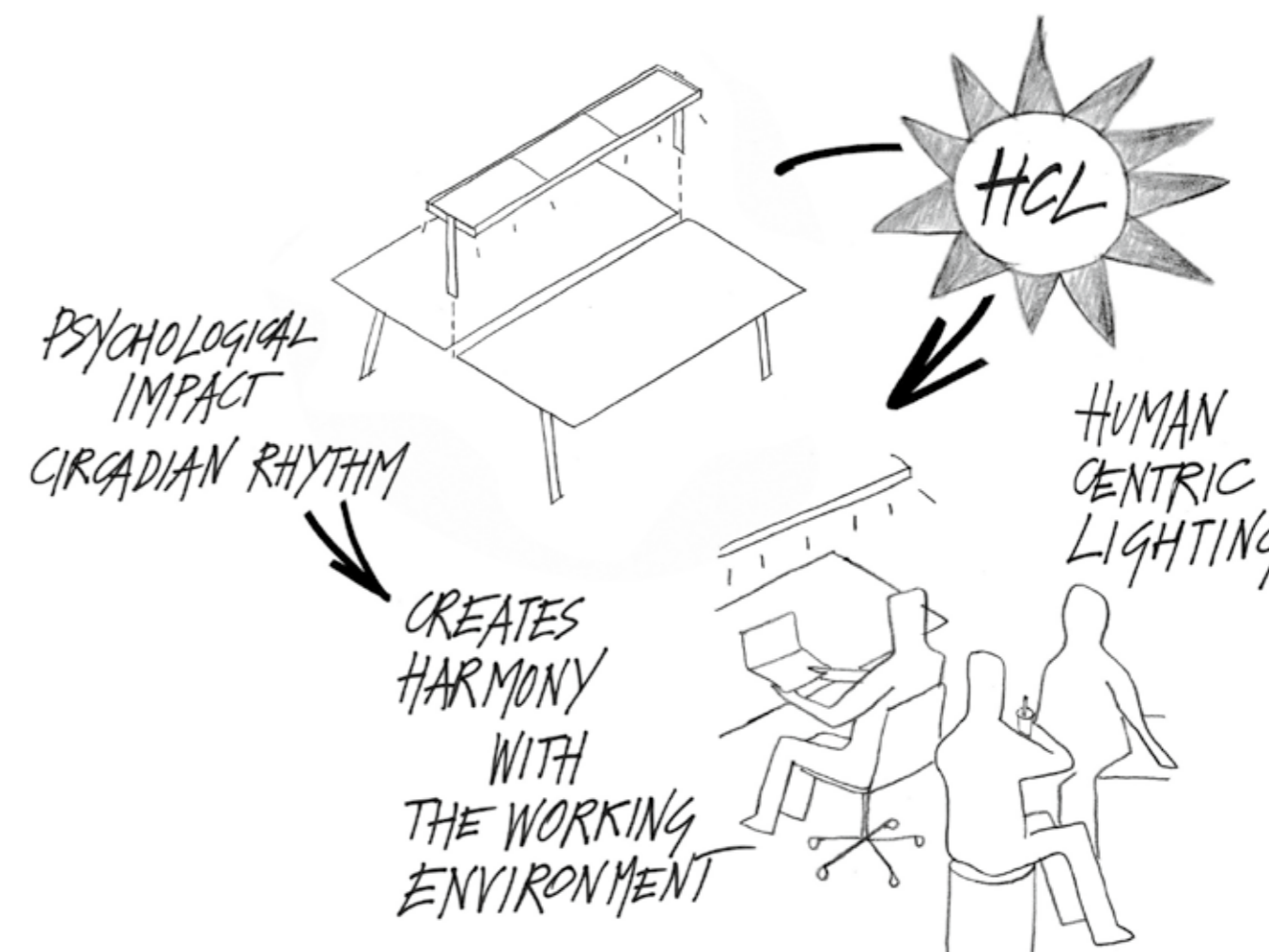

T.REGOLO

R&amp;D by IVM

**T.REGOLO è BENESSERE**

L'ufficio si trasforma e l'ergonomia diventa il fattore chiave per garantire benessere e comfort alle persone.

**T.REGOLO is WELLBEING**

Transform the office and make ergonomics the key to people's wellbeing and comfort.

**T.REGOLO est synonyme de BIEN-ÊTRE**

Le bureau évolue et l'ergonomie devient le facteur essentiel pour garantir le bien-être et le confort des collaborateurs.

**T.REGOLO è DINAMICO**

Basta un facile gesto per cambiare prospettiva e trovare la giusta posizione, in qualsiasi momento.

**T.REGOLO is DYNAMIC**

Make one easy move to change perspective and find the right position at any time.

**T.REGOLO est synonyme de DYNAMISME**

Un simple geste suffit pour changer de perspective et trouver la position adéquate à tout moment.

**T.REGOLO è FUNZIONALITA'**

Lo spazio di lavoro diventa ad assetto variabile per rispondere real time alle diverse esigenze operative e funzionali.

**T.REGOLO is CONVENIENCE**

Turn the workspace into a flexible set-up that responds to the different operational and functional needs in real time.

**T.REGOLO est synonyme de FONCTIONNALITÉ**

L'espace de travail est à géométrie variable afin de répondre aux différentes exigences opérationnelles et fonctionnelles en temps réel.

**NEW FINISHES**

**PIANI**  
TOP  
PLATEAUX

**GRAFITE**  
GRAPHITE  
**CANAPA**  
WARM GREY\_CHANVRE

**VISONE**  
MOSS GREY\_VISON

**OTTANIO**  
PETROL GREEN\_VERT PÉTROLE





# DESK

T.REGOLO DESK - VERTEBRA PASSACAVI - Optional  
caratterizzata da un particolare sistema di aggancio  
CALAMITATO  
che ne facilita il corretto posizionamento alla struttura.

T.REGOLO DESK - CABLE MANAGEMENT VERTEBRAE -  
Optional  
Featuring a special MAGNETIC coupling system that makes  
it  
easier to keep it in the right position.

T.REGOLO DESK - VERTÈBRE PASSE-CÂBLES - En option  
Caractérisée par un système spécial de fixation à AIMANT  
qui facilite son positionnement adéquat sur la structure.

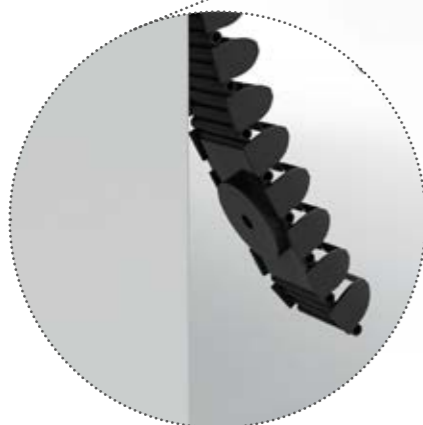

**PORTA CPU SOSPESO**  
adattabile alle diverse dimensioni del cpu stesso.  
Particolarmente efficace nella sua semplicità il sistema  
di "fissaggio" del CPU.

**SUSPENDED CPU HOLDER**  
that can be adapted to the actual size of the cpu.  
The CPU "locking" system is as effective as it is simple.

**SUPPORT UC SUSPENDU**  
adaptable aux différentes dimensions de l'unité centrale.  
La simplicité du système de fixation de l'UC  
est particulièrement efficace.



# 125 65





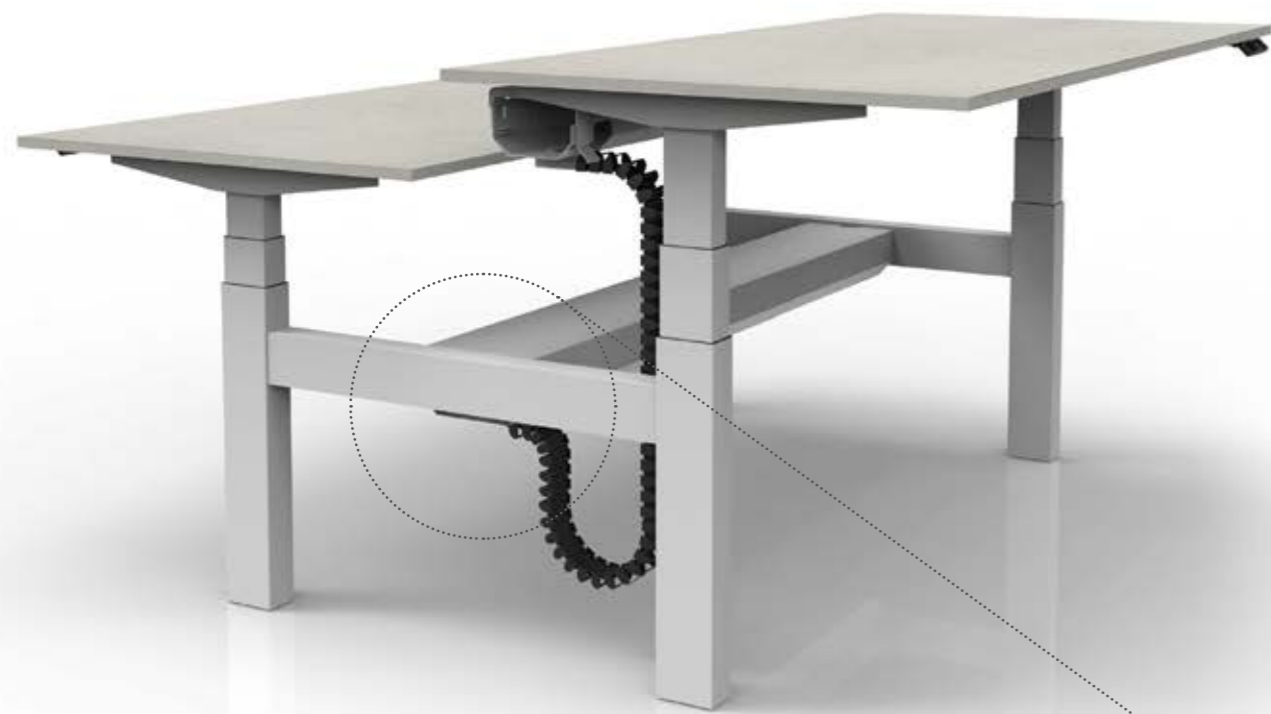
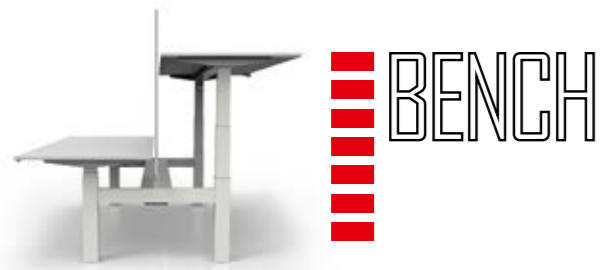

T.REGOLO BENCH - VASCONE per ACCUMULO CAVI - Optional  
T.REGOLO BENCH - CABLE MANAGEMENT TROUGH - Optional  
T.REGOLO BENCH - CHEMIN DE CÂBLES - En option

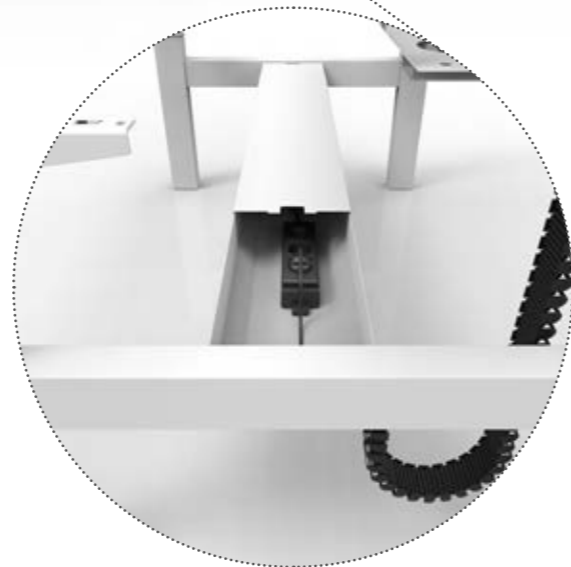

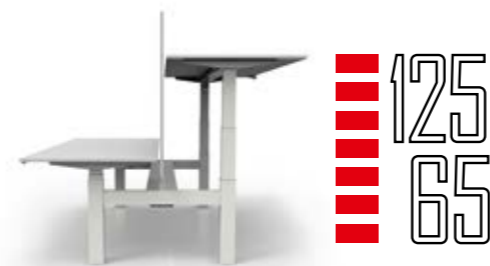

**T.REGOLO BENCH - VASCONE per ACCUMULO CAVI - Optional**  
 Caratterizzato da un carter superiore scorrevole che facilita l'accesso ai cavi, oltre a proteggere gli stessi e a mantenere "ordinata" la postazione.  
 La vertebra passacavi - nella variante BENCH - viene fissata al vassoio passacavi sottopiano ed al vascone stesso.

**T.REGOLO BENCH - CABLE MANAGEMENT TROUGH - Optional**  
 A sliding cover makes it easier to access the cables, as well as protecting them and keeping the workstation tidy.  
 In the BENCH option, the cable management vertebrae is attached to both the under-desk cable tray and the cable trough.

**T.REGOLO BENCH - CHEMIN DE CÂBLES - En option**  
 Caractérisé par un capot supérieur coulissant qui facilite l'accès aux câbles tout en les protégeant.  
 Le poste de travail est ainsi parfaitement rangé.  
 Dans sa variante BENCH, la vertèbre passe-câbles est fixée sur le chemin de câbles en passant sous le bureau.



## T.REGOLO **DESK**



L cm  
120  
140  
160  
180

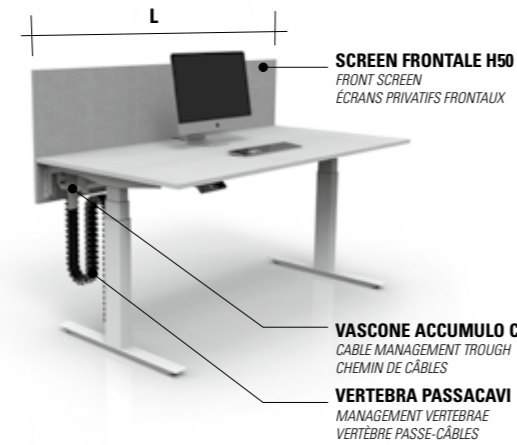

**SCREEN FRONTALE H50**  
FRONT SCREEN  
ÉCRANS PRIVATIFS FRONTAUX

**VASCONE ACCUMULO CAVI**  
CABLE MANAGEMENT TROUGH  
CHEMIN DE CÂBLES

**VERTEBRA PASSACAVI**  
MANAGEMENT VERTEBRAE  
VERTÈBRE PASSE-CÂBLES

## T.REGOLO **BENCH**

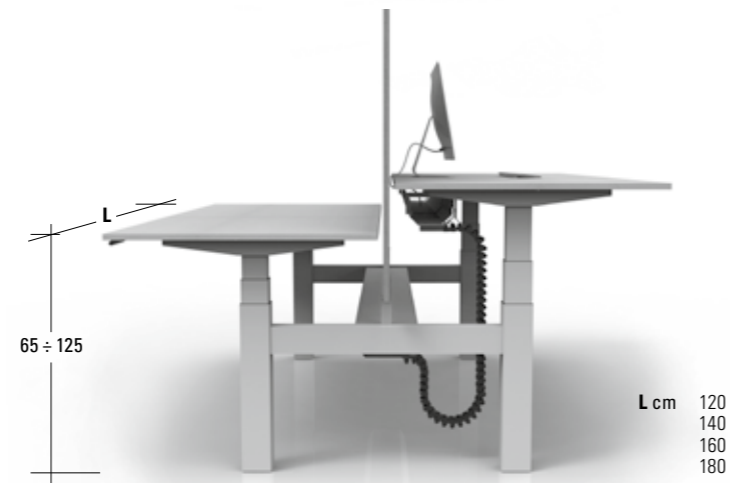

L cm  
120  
140  
160  
180

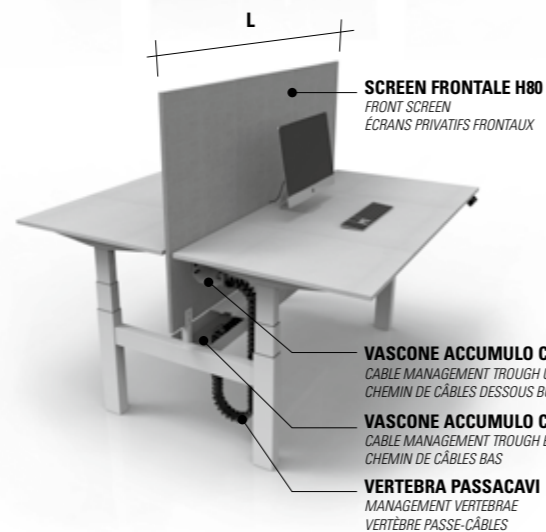

**SCREEN FRONTALE H80**  
FRONT SCREEN  
ÉCRANS PRIVATIFS FRONTAUX

**VASCONE ACCUMULO CAVI SOTTOPIANO**  
CABLE MANAGEMENT TROUGH UNDER THE DESK  
CHEMIN DE CÂBLES DESSOUS BUREAUX

**VASCONE ACCUMULO CAVI BASSO**  
CABLE MANAGEMENT TROUGH BELOW  
CHEMIN DE CÂBLES BAS

**VERTEBRA PASSACAVI**  
MANAGEMENT VERTEBRAE  
VERTÈBRE PASSE-CÂBLES

**FINITURE**  
FINISHES  
FINITIONS



## FINITURE PIANI NOBILITATO

TOP FINISHES  
LAMINATE

FINITIONS PLATEAUX  
MELAMINÉ

LE FINITURE DEI PIANI SONO LIBERAMENTE  
ACCOSTABILI ALLE FINITURE PREVISTE PER LE GAMBE.

MATCH THE TOP FINISH WITH THE FINISH  
SELECTED FOR THE LEGS.

LES FINITIONS DES PLATEAUX SONT COMBINABLES  
AVEC LES FINITIONS PRÉVUES POUR LE PIÈTEMENT.



SPATOLATO CEMENTO  
CEMENT RENDER EFFECT / BÉTON TALOCHÉ

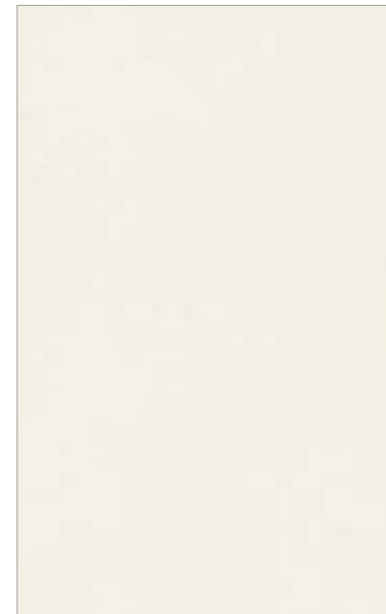

AVORIO  
IVORY / IVOIRE

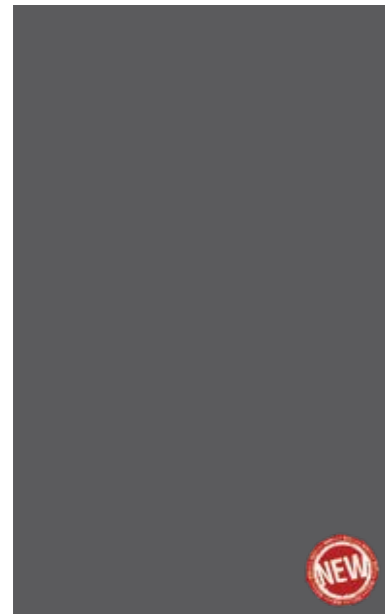

GRAFITE  
GRAPHITE

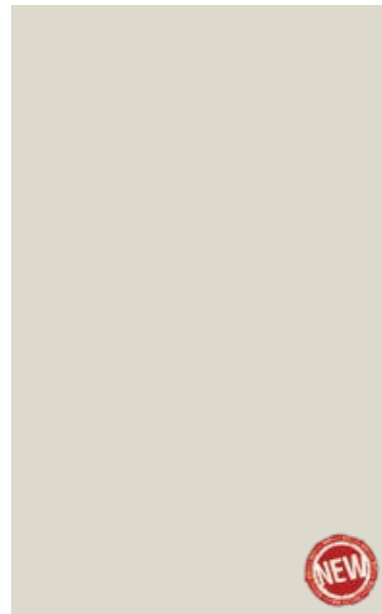

CANAPA  
WARM GREY / CHANVRE

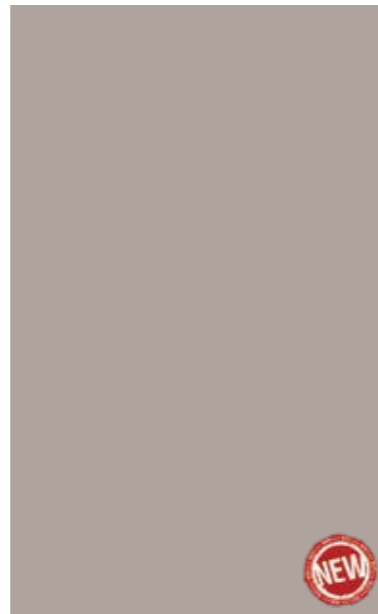

VISONE  
MOSS GREY / VISON



OTTANIO  
PETROL GREEN / VERT PÉTROLE



VULCANO



OLMO PANNA  
ELM CREAM / ORME CRÈME



OLMO TESTA DI MORO  
ELM DARK BROWN / ORME FONCÉ



NOCE  
WALNUT / NOYER

## FINITURE SCREEN NOBILITATO

SCREEN FINISHES  
LAMINATE

FINITIONS ÉCRANS  
MELAMINÉ

LE FINITURE DEGLI SCREEN SONO  
LIBERAMENTE ACCOSTABILI ALLE FINITURE  
PREVISTE PER I PIANI.

MATCH THE SCREEN FINISH WITH THE FINISH  
SELECTED FOR THE TOPS.

LES FINITIONS DES ÉCRANS SONT  
COMBINABLES AVEC LES FINITIONS PRÉVUES  
POUR LE PLATEAUX.



GRAFITE  
GRAPHITE

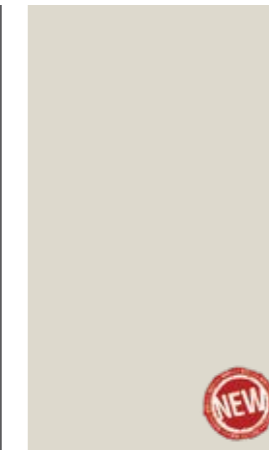

CANAPA  
WARM GREY / CHANVRE

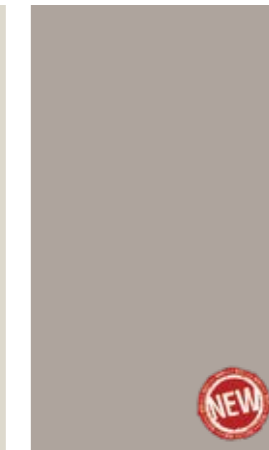

VISONE  
MOSS GREY / VISON



OTTANIO  
PETROL GREEN / VERT PÉTROLE



NOCE  
WALNUT / NOYER

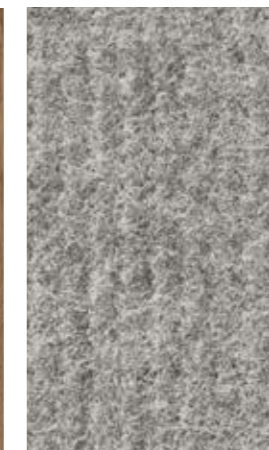

FELTRO  
FELT / FEUTRE



AVORIO  
IVORY / IVOIRE



SPATOLATO CEMENTO  
CEMENT RENDER EFFECT / BÉTON TALOCHÉ



OLMO PANNA  
ELM CREAM / ORME CRÈME



OLMO TESTA DI MORO  
ELM DARK BROWN / ORME FONCÉ



PENELOPE SABBIA  
PENELOPE SAND / SABLE



PENELOPE ARGILLA  
PENELOPE CLAY / ARGILE



ALLUMINIO  
ALUMINIUM



NERO RAL 9005



ALLUMINIO RAL 9006



BIANCO RAL 9016

FINITURE GAMBE  
LEGS FINISHES  
FINITIONS PIÈTEMENT

Per una corretta valutazione di tonalità e colore delle diverse finiture rappresentate a catalogo, è necessario fare riferimento ai campioni fisici.

Due to variances in printed colours, see the swatches for the actual colours and shades of the different finishes.

Pour une évaluation correcte du ton et de la couleur des différentes finitions représentées dans le catalogue, il est nécessaire de se référer aux échantillons physiques.

# SPECIFICHE TECNICHE



## SCRIVANIE composte da:

### PIANI LAVORO in NOBILITATO

Piani lavoro realizzati in conglomerato ligneo sp.18 mm, con densità di circa 650 Kg/m<sup>3</sup>, nobilitati su entrambi i lati mediante l'utilizzo di carte melaminiche a grammatura 120 gr/mq e con finitura superficiale antigraffio ed antiriflesso, nelle finiture Avorio, Spatolato Cemento, Olmo Testa di Moro, Olmo Panna, Noce Canaletto, Vulcano, Grafite, Canapa, Visone e Ottanio. I pannelli presentano una buona resistenza a flessione e trazione, ottima resistenza all'invecchiamento ed alle macchie. I bordi perimetrali sono costituiti da una miscela in ABS, incollati con colla poliuretana ed arrotondati. La reazione al fuoco dei pannelli utilizzati di serie è compresa nella classe seconda.

### GAMBE METALLICHE CON REGOLAZIONE IN ALTEZZA A TRE STADI **\_DA 63,5 A 129,5 CM\_ CONTINUA MOTORIZZATA (T.REGOLO DESK)** **\_DA 61 A 127 CM\_ CONTINUA MOTORIZZATA (T.REGOLO BENCH)**

#### (Tipo A Rif. Normativa EN 527-1:2011)

Gambe metalliche previste in 2 tipologie dimensionali: prof. cm 80 (T.REGOLO DESK) e cm 165 (T.REGOLO BENCH)

Tutte le tipologie di gambe sono verniciate con polveri epossidiche.

Disponibili in 3 varianti di colore: Bianco Ral9016, Nero Ral9005, Alluminio Ral9006

I piedi sono dotati di piedini regolabili con escursione di 12 mm (per un perfetto livellamento al pavimento).

## CARATTERISTICHE SISTEMA DI REGOLAZIONE MOTORIZZATO

Sistema composto da due colonne a tre stadi a sezione rettangolare 90x60 mm completa di sensore anti-collisione che riduce al minimo il rischio di eventuali danni del tavolo sia in direzione di salita che di discesa. Movimento sincronizzato del profilo medio. Cuscinetti di scorrimento interni invisibili per garantire la massima fluidità e silenziosità di movimento.

Centralina di controllo con protezione contro sovraccarichi elettronici con funzione soft start/stop, consumo di corrente in modalità standby di soli 0,1 W, cavo di alimentazione intercambiabile, design Low-profile altezza di soli 35mm.

Comandi di controllo disponibili in due versioni:

- **BASIC** Pulsantiera dotata dei soli comandi di salita e discesa.

- **PLUS** Pulsantiera dotata dei comandi di salita e discesa, di un display a LED per visualizzare l'altezza del piano e di quattro tasti per memorizzare altezze desiderate, disponibile nel colore Nero. Il display, se non utilizzato si spegne autonomamente risparmiando energia.

## SCREEN FRONTALI disponibili in:

**NOBILITATO**, realizzati in conglomerato ligneo sp.18 mm, con densità di circa 650 Kg/m<sup>3</sup>, nobilitati su entrambi i lati mediante l'utilizzo di carte melaminiche a grammatura 120 gr/mq e con finitura superficiale antigraffio ed antiriflesso, nelle finiture Avorio, Spatolato Cemento, Olmo Testa di Moro, Olmo Panna, Noce Canaletto, Feltro, Vulcano, Grafite, Canapa, Visone e Ottanio.

I pannelli presentano una buona resistenza a flessione e trazione, ottima resistenza all'invecchiamento ad alle macchie.

I bordi perimetrali sono costituiti da una miscela in ABS, incollati con colla poliuretana ed arrotondati.

La reazione al fuoco dei pannelli utilizzati di serie è compresa nella classe seconda.

Disponibili nella configurazione RETTANGOLARE, nelle dimensioni in larghezza delle scrivanie (120-140-160-180) e in due altezze:

H.cm 50 per T.REGOLO DESK; H.cm 80 per T.REGOLO BENCH.

## MODESTY PANEL

Realizzati in conglomerato ligneo sp.18 mm, con densità di circa 650 Kg/m<sup>3</sup>, nobilitati su entrambi i lati mediante l'utilizzo di carte melaminiche a grammatura 120 gr/mq e con finitura superficiale antigraffio ed antiriflesso, nelle finiture Avorio, Vulcano, Spatolato Cemento, Olmo Testa di Moro, Olmo Panna, Noce Canaletto, Vulcano, Grafite, Canapa, Visone e Ottanio.

I pannelli presentano una buona resistenza a flessione e trazione, ottima resistenza all'invecchiamento ad alle macchie.

I bordi perimetrali sono costituiti da una miscela in ABS, incollati con colla poliuretana ed arrotondati.

La reazione al fuoco dei pannelli utilizzati di serie è compresa nella classe seconda.

I pannelli sono agganciati alla struttura tramite una coppia di staffe metalliche sp.3 mm verniciate con polveri epossidiche nei colori previsti per le gambe.

## BRACCIO PORTA MONITOR

Realizzato in pressofusione di alluminio verniciato nei colori Bianco o Nero, con sistema di bilanciamento monitor a cinghia che permette l'applicazione di monitor da 0 a 9 kg. Regolazione bilanciamento tramite rotella, senza l'utilizzo di nessun utensile. Rotazione a 360° con possibilità di bloccarne la rotazione a 180° (+90°/-90°). Piastra per aggancio monitor a c lip, rotazione 360° ed attacco VESA 75 & 100.

## PORTA CPU SOSPESO

- **Modello BIG** Realizzato in lamiera piegata verniciata con polveri epossidiche nel colore Bianco opaco Ral 9016, Nero o Alluminio. Possibilità di regolazione in Altezza da 37,7 a 53, 2 cm e in Larghezza da 7,8 a 22 cm. Peso massimo CP U 15 Kg.

## CANALIZZAZIONE

### VASCONE accumulo CAVI sottopiano per SCRIVANIE T.REGOLO DESK

Realizzato in lamiera piegata verniciata con polveri epossidiche. Telescopico. Disponibile in 3 varianti di colore: Bianco Ral9016, Nero Ral9005, Alluminio Ral9006

### VASCONE accumulo CAVI - sottopiano - per SCRIVANIE T.REGOLO BENCH

Realizzato in lamiera piegata verniciata con polveri epossidiche. Disponibile in 3 varianti di colore: Bianco Ral9016, Nero Ral9005, Alluminio Ral9006

### VASCONE accumulo CAVI - basso - per SCRIVANIE T.REGOLO BENCH

Composto da una vasca realizzata in lamiera piegata, collegata alla struttura. Disponibile in 3 varianti di colore: Bianco Ral9016, Nero Ral9005, Alluminio Ral9006

### TOP ACCESS

Realizzati in Alluminio, con plastiche di chiusura laterale in ABS, sono disponibili in finitura Verniciato Bianco o Brill.

L'apertura del coperchio è disponibile nella versione Frontale.

Per il supporto delle multiprese possono essere utilizzate apposite vaschette portacavi (optional) oppure i vasconi per accumulo cavi.

**Tutti i materiali utilizzati sono conformi alle norme UNI EN e sono certificati per il 90% CARB 2 (relativamente all'emissione di formaldeide).**

# TECHNICAL SPECIFICATIONS

DESKS formed of:

## LAMINATE TOPS

Tops made from 18 mm-thick particleboard, with a density of about 650 kg/m<sup>3</sup>, laminated on both sides by a layer of melamine-coated paper (120 g/m<sup>2</sup>), with a scratch-proof and anti-reflective surface, in the following finishes: Ivory, Cement Render Effect, Dark Brown Elm, Cream Elm, Black Walnut, Vulcano, Graphite, Warm Grey, Moss Grey and Petrol Green.

The panels have high bending and tensile strength, and excellent resistance to ageing and stains.

The edges are made from an ABS compound, fixed with polyurethane glue and rounded.

The standard panels used are classified for reaction to fire in Class 2.

## METAL LEGS WITH THREE-STAGE CONTINUOUS MOTORISED ELECTRICAL HEIGHT ADJUSTMENT (63,5 - 129,5 CM) (T.REGOLO DESK) (61 - 127 CM) (T.REGOLO BENCH)

### (Type A Reference Standard EN 527-1:2011)

Metal legs in two sizes: depth of 80 cm (T.REGOLO DESK) and 165 cm (T.REGOLO BENCH)

All leg types come with epoxy powder-coated finish.

Available in three colours: White (Ral 9016), Black (Ral 9005), Aluminium (Ral 9006)

The glides are fitted with 12 mm adjustable levellers (to sit squarely on the floor).

## SPECIFICATIONS OF ELECTRICALLY ACTUATED SYSTEM

System consisting of two, three-stage rectangular columns (90x60 mm) complete with impact sensor to minimise the risk of damage to the table when rising and/or descending. Synchronised movement of middle profile. Invisible inner sliding bearings for smooth, silent movement. Control box with electronic overload protection with Soft-Start/Stop function; stand-by power consumption (0.1 W); interchangeable power cable; low-profile design (only 35 mm high).

Control commands available in two versions:

- **BASIC** - Control panel fitted with up and down buttons only.
- **PLUS** - Control panel fitted with up and down buttons, LED display for height readout and four memory position buttons, available in Black. The display switches off when not in use to save power.

## FRONT SCREENS available as follows:

### LAMINATE

Made from 18 mm-thick particleboard, with a density of about 650 kg/m<sup>3</sup>, laminated on both sides by a layer of melamine-coated paper (120 g/m<sup>2</sup>), with a scratch-proof and anti-reflective surface, in the following finishes: Ivory, Cement Render Effect, Dark Brown Elm, Cream Elm, Black Walnut, Felt, Vulcano, Graphite, Warm Grey, Moss Grey and Petrol Green.

The panels have high bending and tensile strength, and excellent resistance to ageing and stains.

The edges are made from an ABS compound, fixed with polyurethane glue and rounded.

The standard panels used are classified for reaction to fire in Class 2.

Available in the RECTANGLE configuration, the same widths as the desks (120, 140, 160, 180 mm) and in two heights:

50 cm (T.REGOLO DESK) and 80 cm (T.REGOLO BENCH).

## MODESTY PANEL

Made from 18 mm-thick particleboard, with a density of about 650 kg/m<sup>3</sup>, laminated on both sides by a layer of melamine-coated paper (120 g/m<sup>2</sup>), with a scratch-proof and anti-reflective surface, in the following finishes: Ivory, Cement Render Effect, Dark Brown Elm, Cream Elm, Black Walnut, Vulcano, Graphite, Warm Grey, Moss Grey and Petrol Green.

The panels have high bending and tensile strength, and excellent resistance to ageing and stains.

The edges are made from an ABS compound, fixed with polyurethane glue and rounded.

The standard panels used are classified for reaction to fire in Class 2.

The panels are coupled to the structure by means of two, 3 mm thick metal brackets with epoxy powder-coated finish available in the same colours as the legs.

## DESK MOUNT MONITOR ARM

Made from White or Black painted die-cast aluminium, with strap-on monitor balancing that supports monitors of 0 to 9 kg. Tool-free wheel balance adjustment. 360° rotation lockable at 180° (+90°/-90°). Clip-on monitor attachment plate, 360° rotation and VESA mount 75 & 100.

## SUSPENDED CPU HOLDER

- **BIG model** Made from sheet metal, with epoxy powder-coated finish in matte White (Ral 9016), Black or Aluminium. Height adjustment from 37.7 to 53.2 cm. Width adjustment from 7.8 to 22 cm. Maximum weight of CPU: 15 kg.

## CABLE MANAGEMENT SYSTEMS

### Undermount CABLE management TRAY for T.REGOLO DESK (DESK)

Made from sheet metal, with epoxy powder-coated finish. Telescopic. Available in four colours: White (Ral 9016), Black (Ral 9005), Aluminium (Ral 9006)

### Undermount CABLE management TRAY for T.REGOLO DESK (BENCH)

Made from sheet metal, with epoxy powder-coated finish. Available in four colours: White (Ral 9016), Black (Ral 9005), Aluminium (Ral 9006)

### Low CABLE management TRAY for T.REGOLO DESK (BENCH)

Consisting of a tray made from bent sheet metal attached to the framework. Available in three colours: White (Ral 9016), Black (Ral 9005), Aluminium (Ral 9006)

### TOP ACCESS

Made from Aluminium, with ABS end caps, they come in White or Brill finish. The lid can be opened in the FRONT version. The power strips can be stored in specific cable management trays (optional) or in the cable management trays.

All materials used comply with UNI EN standards, and 90% of its production is certified to CARB 2 (formaldehyde emissions).

# SPÉCIFICATIONS TECHNIQUES

BUREAUX composés de :

## PLANS DE TRAVAIL en MÉLAMINÉ

Plans de travail réalisés en bois aggloméré de 18 mm d'épaisseur, avec une densité d'environ 650 kg/m<sup>3</sup> ; revêtement en mélaminé sur les deux côtés (grammage papier : 120 g/m<sup>2</sup>) ; traitement anti-rayures et antireflet.

Finitions disponibles :Ivoire, Béton Taloché, Orme Foncé, Orme Crème, Noyer Noir, Vulcano, Graphite, Chanvre, Vison et Vert Pétrole.

Les panneaux ont une bonne résistance à la flexion et à la traction et une excellente résistance au vieillissement et aux taches.

Les chants sur le pourtour sont en ABS, collés avec de la colle polyuréthane et arrondis.

Les panneaux de série sont classés en catégorie 2 pour ce qui concerne la réaction au feu.

## PIEDS MÉTALLIQUES AVEC RÉGLAGE EN HAUTEUR À TROIS ÉTAGES \_DE 63,5 À 129,5 CM\_ CONTINU MOTORISÉ (T.REGOLO DESK) \_DE 61 À 127 CM\_ CONTINU MOTORISÉ (T.REGOLO BENCH)

### (Type A Réf. norme EN 527-1 :2011)

Pieds métalliques prévus en 2 dimensions : prof.80 cm (T.REGOLO DESK) et 165 cm (T.REGOLO BENCH)

Tous les types de pieds sont peints avec des poudres époxy.

Ils sont disponibles en 3 variantes de couleur : Blanc Ral9016, Noir Ral9005, Aluminium Ral9006

Les pieds sont munis de vérins réglables de 12 mm (pour une mise à niveau parfaite).

## CARACTÉRISTIQUES SYSTÈME DE RÉGLAGE MOTORISÉ

Système composé de deux colonnes à trois étages de section rectangulaire 90x60 mm avec capteur anti-collision qui réduit au minimum le risque de dommages éventuels au plateau à la montée comme à la descente. Mouvement synchronisé du profil moyen.

Paliers de glissement internes invisibles pour assurer un mouvement fluide et silencieux.

Centrale de commande avec protection contre les surcharges électroniques avec fonction Soft-Start/Stop, consommation d'énergie en mode veille de seulement 0,1 W, cordon d'alimentation interchangeable, ligne compacte de seulement 35 mm de hauteur.

Commandes de contrôle disponibles en deux versions :

- **BASIC** - Boîte à boutons munie des commandes de montée et descente uniquement.
- **PLUS** - Boîte à boutons munie des commandes de montée et descente, d'un afficheur à LED pour visualiser la hauteur du plateau et de quatre touches pour enregistrer les hauteurs souhaitées, disponible dans la couleur Noir. En cas d'inutilisation, l'afficheur s'éteint automatiquement pour économiser l'énergie.

## ÉCRANS PRIVATIFS FRONTAUX disponibles en :

**MÉLAMINÉ**, réalisés en bois aggloméré de 18 mm d'épaisseur, avec une densité d'environ 650 kg/m<sup>3</sup> ; revêtement en mélaminé sur les deux côtés (grammage papier : 120 g/m<sup>2</sup>) ; traitement anti-rayures et antireflet. Finitions disponibles :Ivoire, Béton Taloché, Orme Foncé, Orme Crème, Noyer Noir, Feutre, Vulcano, Graphite, Chanvre, Vison et Vert Pétrole.

Les panneaux ont une bonne résistance à la flexion et à la traction et une excellente résistance au vieillissement et aux taches.

Les chants sur le pourtour sont en ABS, collés avec de la colle polyuréthane et arrondis.

Les panneaux de série sont classés en catégorie 2 pour ce qui concerne la réaction au feu.

Disponibles dans la version RECTANGULAIRE, dans les mêmes largeurs que les bureaux (120-140-160-180) et en deux hauteurs :

H 50 cm pour T.REGOLO DESK ; H 80 cm pour T.REGOLO BENCH.

## VOILE DE FOND

Réalisé en bois aggloméré de 18 mm d'épaisseur, avec une densité d'environ 650 kg/m<sup>3</sup> ; revêtement en mélaminé sur les deux côtés (grammage papier : 120 g/m<sup>2</sup>) ; traitement anti-rayures et antireflet. Finitions disponibles :Ivoire, Béton Taloché, Orme Foncé, Orme Crème, Noyer Noir, Vulcano, Graphite, Chanvre, Vison et Vert Pétrole.

Les panneaux ont une bonne résistance à la flexion et à la traction et une excellente résistance au vieillissement et aux taches.

Les chants sur le pourtour sont en ABS, collés avec de la colle polyuréthane et arrondis.

Les panneaux de série sont classés en catégorie 2 pour ce qui concerne la réaction au feu.

Les panneaux sont fixés à la structure par une paire de brides métalliques de 3 mm d'épaisseur peintes avec des poudres époxy dans les couleurs prévues pour les pieds.

## BRAS PORTE-ÉCRAN

Réalisé en aluminium moulé sous pression et peint de couleur Blanc ou Noir, avec système d'équilibrage de l'écran à courroie qui permet l'application d'écrans de 0 à 9 kg. Réglage de l'équilibrage avec la molette, sans utilisation d'aucun outil. Rotation à 360° avec possibilité de bloquer la rotation à 180° (+90°/-90°). Plaque de fixation de l'écran à clip, rotation à 360° et fixation VESA 75 et 100.

## SUPPORT UC SUSPENDU

- **Modèle BIG** réalisé en tôle pliée peinte avec des poudres époxy de couleur Blanc mat RAL9016, Noir ou Aluminium. Possibilité de réglage en hauteur de 37,7 à 53,2 cm et en largeur de 7,8 à 22 cm. Poids maximum UC : 15 kg.

## CANALISATION

### CHEMIN DE CÂBLES sous le plan pour BUREAUX T.REGOLO (DESK)

Réalisé en tôle pliée et peinte avec des poudres époxy. Téléscopique. Disponible en 3 variantes de couleur : Blanc Ral9016, Noir Ral9005, Aluminium Ral9006

### CHEMIN DE CÂBLES - sous le plan - pour BUREAUX T.REGOLO (BENCH)

Réalisé en tôle pliée et peinte avec des poudres époxy. Disponible en 3 variantes de couleur : Blanc Ral9016, Noir Ral9005, Aluminium Ral9006

### CHEMIN DE CÂBLES - bas - pour BUREAUX T.REGOLO (BENCH)

Composé d'un logement en tôle pliée, raccordé à la structure. Ils sont disponibles en 3 variantes de couleur : Blanc Ral9016, Noir Ral9005, Aluminium Ral9006

### TOP ACCESS

Réalisés en aluminium, avec couvercles latéraux en ABS, disponibles dans la finition peint Blanc ou Brill. L'ouverture du couvercle est disponible dans la version frontale.

Pour le support des multiprises, il est possible d'utiliser des boîtes à câbles appropriées (en option) ou les chemins de câbles.

Tous les matériaux employés sont conformes aux normes UNI EN et sont certifiés CARB 2 (concernant l'émission de formaldéhyde) pour 90 % de la production.

FUNNY.SAT

DESIGN by STEFANO BIGI

BREVETTO N°003659648-0001  
del 19/01/2107

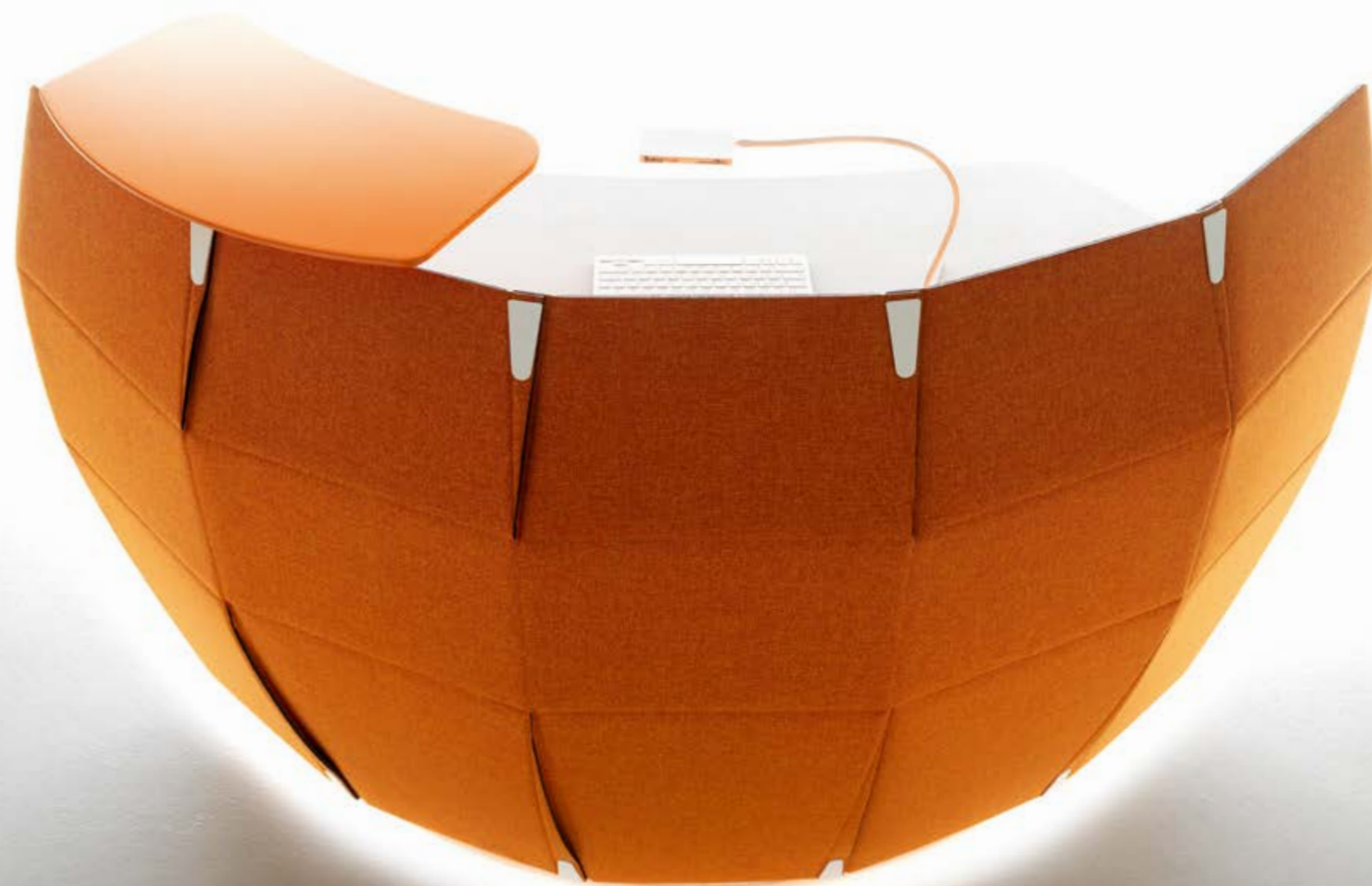



FUNNY.SAT  
WELCOME

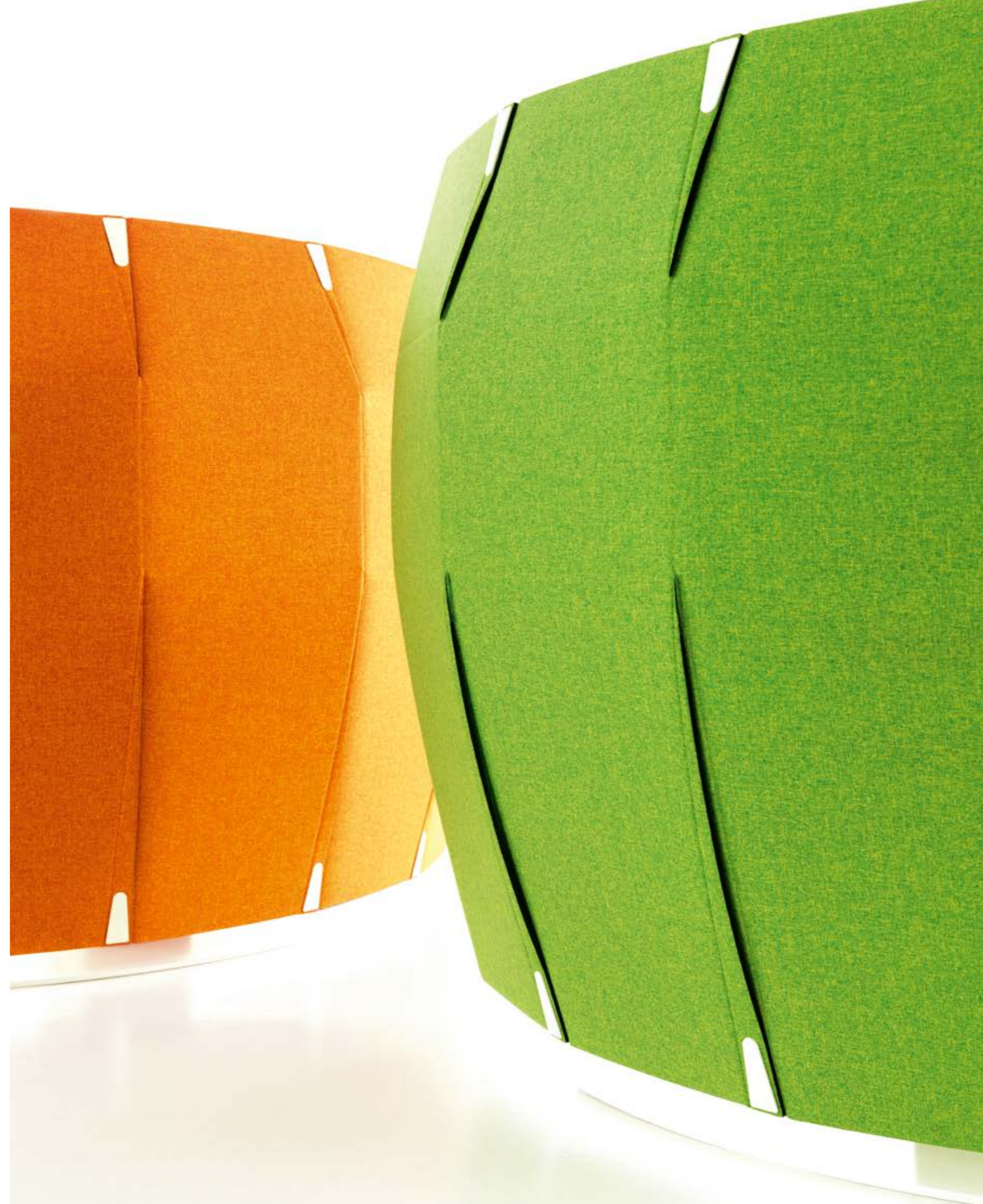



HEIGHT  
ADJUSTABLE



FIXED

FLESSIBILITÀ  
MULTIDISCIPLINARITÀ  
CREATIVITÀ



Il piano scrivania è regolabile in altezza da cm 75 a cm 115.  
The desktop can be adjusted in height from 75 cm to 115 cm.  
Le plateau de bureau est réglable en hauteur de 75 cm à 115 cm.

HEIGHT  
ADJUSTABLE



DETAILS







## SOUND ABSORBING



L'esigenza di vivere e lavorare in ambienti meno rumorosi trova in FUNNY.SAT una risposta immediata.

Il particolare pannello frontale semisferico, realizzato in materiale ad alto assorbimento acustico consente una correzione acustica in modo semplice ed immediato.

Un design creativo pensato per ottimizzare anche il benessere acustico.

FUNNY.SAT is the perfect solution for those needing to live and work in less noisy environments.

The distinctive semi-spherical front panel, made from high sound absorbing material, offers a simple, immediate way to achieve acoustic improvement.

A creative product, designed with acoustic wellbeing in mind.

L'exigence de vivre et de travailler dans un environnement moins bruyant trouve une réponse immédiate grâce à FUNNY.SAT.

Le panneau avant semi-sphérique particulier, réalisé en matériau à haute absorption acoustique, permet d'obtenir une correction acoustique de manière simple et instantanée.

Un design créatif conçu pour optimiser aussi le bien-être acoustique.



### ALTO ASSORBIMENTO ACUSTICO

HIGH SOUND ABSORPTION  
HAUTE ABSORPTION ACOUSTIQUE

ACOUSTIC  
COMFORT

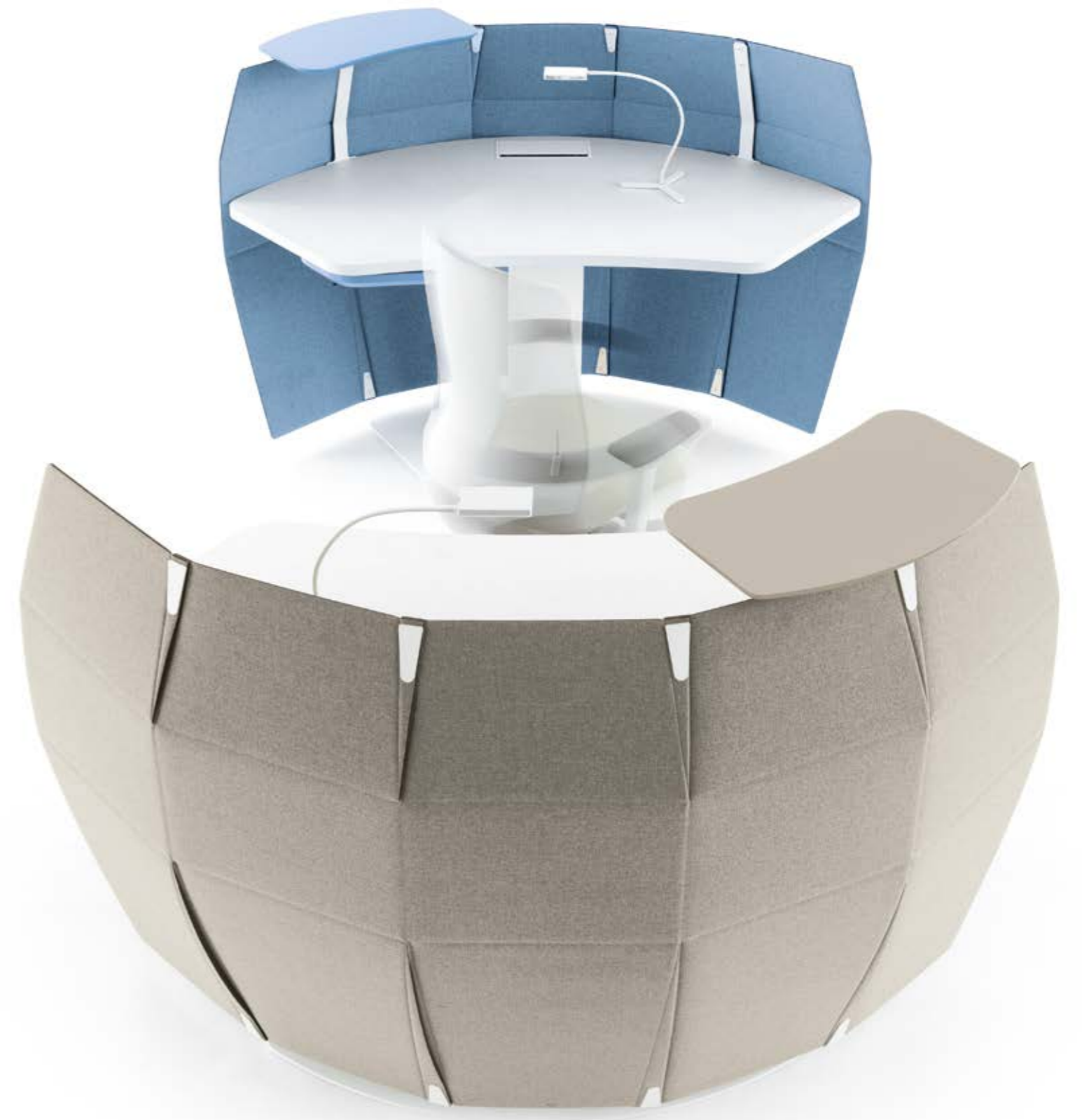

PANNELLO MONOMATERICO  
REALIZZATO 100% PET

SINGLE-MATERIAL PANEL MADE FROM 100% PET  
PANNEAU RÉALISÉ EN UN SEUL MATÉRIAU 100% PET



FRONT



BACK

# SIZE



- Il pannello è ottenuto tramite TERMOFORMATURA di un "sandwich" a tre strati così composto:
1. Tessuto 100% Poliestere FR (Tr-Cs)  
Peso gr/ml 470 - Resistenza al fuoco Italia Classe 1
  2. Fibra di Poliestere  
Spessore 12 mm - Reazione al fuoco Classe 1
  3. Tessuto 100% Poliestere FR (Tr-Cs)  
Peso gr/ml 470 - Resistenza al fuoco Italia Classe 1

- The panel is made by THERMOFORMING a "sandwich" of three layers, made up as follows:
1. Fabric in 100% Polyester FR (Tr-Cs)  
Weight gr/ml 470 - Fire resistant Italy Class 1
  2. Polyester fibre  
Thickness 12 mm - Class 1 standard reaction to fire
  3. Fabric in 100% Polyester FR (Tr-Cs)  
Weight gr/ml 470 - Fire resistant Italy Class 1

- Le panneau est obtenu par THERMOFORMAGE d'un « sandwich » à trois couches constitué des matériaux suivants :
1. Tissu 100 % polyester FR (Trevira CS)  
Poids 470 g/ml - Résistance au feu Italie : Classe 1
  2. Fibre de polyester  
Épaisseur 12 mm - Réaction au feu Classe 1
  3. Tissu 100 % polyester FR (Trevira CS)  
Poids 470 g/ml - Résistance au feu Italie : Classe 1

# FABRICS

Pannelli FRONTALI WELCOME, SCREEN, MODESTY PANEL e CAPPELLO LAMPADA sono disponibili in 4 varianti di colore: AZZURRO, VERDE, ARANCIO e SABBIA.

WELCOME FRONT PANELS, SCREENS, MODESTY PANELS and LAMP TOPS are available in four colours: SKY BLUE, GREEN, ORANGE and SAND.

Les panneaux de FAÇADE WELCOME, ÉCRAN PRIVATIF, VOILE DE FOND et ABAT-JOUR sont disponibles en 4 variantes de couleur : BLEU, VERT, ORANGE et SABLE.

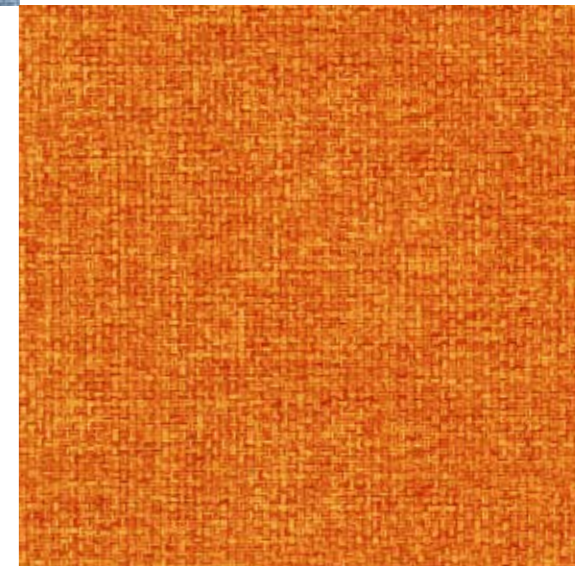
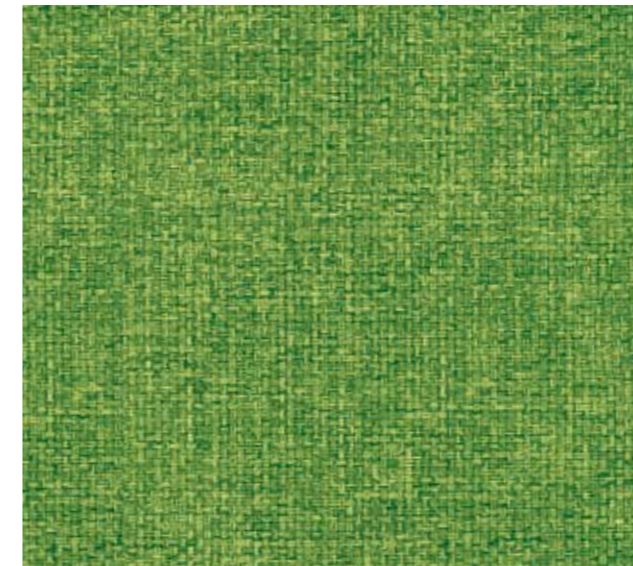

Il piano scrivania, sia per la variante WELCOME che per la variante DESK è in SPATOLATO CEMENTO (spess. mm.30).

The desktop for the WELCOME version and for the DESK version comes in RENDERED CEMENT EFFECT (30 mm thick).

Le plateau de bureau, tant sur la version WELCOME que DESK, est en BÉTON TALOCHÉ (épaisseur 30 mm).



Per una corretta valutazione di tonalità e colore delle diverse finiture rappresentate a catalogo, è necessario fare riferimento ai campioni fisici.

Due to variances in printed colours, see the swatches for the actual colours and shades of the different finishes.

Modello **WELCOME** composto da:

**PIANO LAVORO in NOBILITATO**

Piano lavoro realizzato in conglomerato ligneo sp.30 mm, con densità di circa 650Kg/m³, nobilitati su entrambi i lati mediante l'utilizzo di carte melaminiche a grammatura 120gr/mq e con finitura superficiale antigraffio ed antiriflesso, nella finitura **Spatolato Cemento**. Il pannello è dotato di certificazione ambientale FSC, siglato EPF-S e conforme alle norme UNI. Il pannello presenta una buona resistenza a flessione e trazione, ottima resistenza all'invecchiamento e alle macchie. I bordi perimetrali sono costituiti da una miscela in ABS, incollati con colla poliuretanicca ed arrotondati. La reazione al fuoco del pannello utilizzato di serie è compresa nella classe seconda.

**GAMBA METALLICA FISSA (variante commerciale FIXED)**

Gamba metallica composta da una colonna verticale in tubolare metallico a sezione rettangolare 200x150x sp.4 mm e da una base sagomata in Lamiera di metallo sp.6 mm con finitura verniciata con polveri epossidiche nel colore Bianco opaco Ral9016. Sulla parte superiore della colonna è saldata una piastra metallica con funzione di aggancio al piano. La base è dotata di feltri per appoggio al pavimento.

**GAMBA METALLICA CON REGOLAZIONE IN ALTEZZA A DUE STADI\_ DA 72 A 115 CM\_ CONTINUA MOTORIZZATA**

Gamba metallica composta da una colonna verticale esterna FISSA e da una colonna INTERNA TELESCOPICA di sollevamento MOTORIZZATA e da una base sagomata in Lamiera di metallo sp.6 mm. La colonna ESTERNA e la BASE sono verniciate con polveri epossidiche nel colore Bianco opaco Ral9016. La colonna interna telescopica è in Alluminio finitura Anodizzato Argento Naturale.

Il sistema di **REGOLAZIONE IN ALTEZZA è LINAK** ed ha le seguenti caratteristiche:

- Sistema composto da una colonna a due stadi a sezione rettangolare 194x147 mm. Cuscinetti di scorrimento interni invisibili per garantire la massima fluidità e silenziosità di movimento. Centralina di controllo con protezione contro sovraccarichi elettronici con funzione soft start/stop. Consumo di corrente in modalita standby di soli 0.1W; cavo di alimentazione intercambiabile. Comando di controllo: pulsantiera incassata nel piano dotata dei soli comandi di salita e discesa disponibile nel colore Bianco.

**PANNELLO FRONTALE SEMISFERICO FONOASSORBENTE IN TESSUTO**

Il pannello SEMISFERICO in materiale FONOASSORBENTE è la parte caratterizzante del prodotto.

Il pannello è ottenuto tramite TERMOFORMATURA di un "sandwich" a tre strati così composto:

1. Tessuto 100% Poliestere FR (Tr-Cs) peso gr/ml.470 resistenza al fuoco Italia Classe 1.
2. Fibra di Poliestere spessore 12 mm. Reazione al fuoco Classe 1.
3. Tessuto 100% Poliestere FR (Tr-Cs) peso 470 gr/ml. resistenza al fuoco Italia Classe 1.

Il pannello, nasce PIATTO, al fine di evitare eventuali pieghe o bolle al tessuto. Per poter ottenere dal pannello PIATTO il pannello SEMISFERICO sono state create una sequenza di SCHIACCIAMENTI \_positivi e negativi\_ TRIANGOLARI di dimensioni diverse: più corti (Lunghezza 260 mm. con inclinazione 9°) nella parte superiore, più lunghi (Lunghezza 560 mm con inclinazione 5°) nella parte inferiore, oltre a "Cannettature" arrotondate\_ orizzontali e verticali\_ di profondità 3 mm. In ogni TRIANGOLO sono stati realizzati una coppia di fori. Sovrapponendo una coppia di TRIANGOLI \_positivo e negativo\_ ed allineando i fori presenti su di essi (bloccandoli mediante due piastre in metallo) dal pannello PIATTO si ottiene il pannello SEMISFERICO.

**PIASTRE per AGGANCIO PANNELLO FRONTALE al PIANO SCRIVANIA**

Il PANNELLO FRONTALE è agganciato al piano SCRIVANIA tramite staffe in metallo sp.5 mm, sagomate e verniciate con polveri epossidiche nel colore Bianco opaco Ral9016. Sono disponibili in due versioni: PER TOP WELCOME e SENZA TOP WELCOME

Le configurazioni FUNNY SAT WELCOME disponibili sono tre:

- **NON PREDISPOSTO PER TOP:** Le staffe consentono il solo aggancio del pannello al piano.
- **PREDISPOSTO PER UN TOP WELCOME:** Le staffe consentono oltre all'aggancio del pannello al piano anche il posizionamento a Destra o Sinistra di un TOP WELCOME (il posizionamento avviene in fase di montaggio).
- **PREDISPOSTO PER DUE TOP WELCOME:** Le staffe consentono oltre all'aggancio del pannello frontale al piano anche il posizionamento di DUE TOP WELCOME.

**TOP WELCOME**

Realizzato in MDF sp.18 mm con spigoli arrotondati e bordo perimetrale sagomato, disponibili nella finitura Laccato Opaco nei colori ARANCIO, VERDE, AZZURRO e SABBIA.

**CASSETTINO SOTTOPIANO**

Realizzato in MDF sp.40 mm con spigoli arrotondati e bordo perimetrale sagomato, disponibili nelle finitura Laccato Opaco nei colori ARANCIO, VERDE, AZZURRO e SABBIA. Il cassetto, disponibile nelle varianti Destra o Sinistra, è completo di serratura con chiave dotata di cappuccio in Zama verniciato in colore Bianco Opaco Ral9016. Il cassetto è agganciato al piano tramite un perno in metallo per rendere la rotazione fluida e silenziosa (tra perno cassetto è inserita una boccia in Teflon di colore Nero) Il sistema è completo di fermo sia in Apertura che Chiusura.

**PORTA CPU SOSPESO**

**Modello SLIM** Realizzato in lamiera piegata verniciata con polveri epossidiche nel colore Bianco opaco Ral9016. Possibilità di regolazione in Altezza da 20 a 35,8 cm, in Larghezza da 5 a 10 cm e in Profondità da 12,5 cm a 36 cm. Peso massimo CPU 12Kg. Dotato di serratura.

**Modello BIG** Realizzato in lamiera piegata verniciata con polveri epossidiche nel colore Bianco opaco Ral9016. Possibilità di regolazione in Altezza da 37,7 a 53, 2 cm e in Larghezza da 7,8 a 22 cm. Peso massimo CPU 15Kg.

**WELCOME** model composed of:

**LAMINATE TOP**

Top made from 30 mm-thick particleboard, with a density of about 650 kg/m³, covered on both sides by a layer of melamine-coated paper (120 g/m²), with a scratch-proof and anti-reflective surface, in **Cement Render Effect** finish. The panel comes with FSC environmental certification, EPF-S initialed and complies with UNI standards. The panel has high bending and tensile strength, and excellent resistance to ageing and stains. The edges are made from an ABS compound, fixed with polyurethane glue and rounded. The standard panel used is classified for reaction to fire in Class 2.

**FIXED METAL LEG (trade version FIXED)**

Metal leg composed of a vertical upright in rectangular tubular steel (200x150x4 mm) and a 6 mm-thick shaped sheet metal base with epoxy powder-coated finish of Ral 9016 matte White. A metal plate is welded to the top of the upright for attachment to the top. The base comes with felt glides that rest on the floor.

**METAL LEG WITH TWO-STEP HEIGHT ELECTRICAL ADJUSTMENT (72 - 115 CM)**

Metal leg composed of a FIXED external vertical column and an electrically actuated INNER TELESCOPIC lifting column plus a 6 mm-thick shaped sheet metal base. The EXTERNAL column and the BASE have an epoxy powder-coated finish of Ral 9016 matte White. The inner telescopic column is made from Aluminium (Natural Anodised Silver finish).

The LINAK HEIGHT-ADJUSTMENT SYSTEM has the following specifications:

- System composed of a rectangular two-stage column (194x147 mm). Invisible inner sliding bearings for smooth, silent movement. Control box with electronic overload protection with soft start-stop function. Stand-by power consumption (0.1 W); interchangeable power cable. Control command: control panel recessed into the top, fitted with up and down buttons only, available in White.

**HEMISPHERICAL FABRIC SOUND-ABSORBING FRONT PANEL**

The HEMISPHERICAL panel made from SOUND-ABSORBING material is a feature of the product.

The panel is obtained by THERMOFORMING a three-layer "sandwich" as follows:

1. Fabric: 100% FR (Trevira CS) polyester. Weight: 470 g/ml. Fire-resistance rating (Italy): Class 1.
2. 12 mm-thick polyester fibre. Reaction to fire: Class 1.
3. Fabric: 100% FR (Trevira CS) polyester. Weight: 470 g/ml. Fire-resistance rating (Italy): Class 1.

The panel is created FLAT in order to prevent creases or blubbing from forming on the fabric. To turn the FLAT panel into a HEMISPHERICAL panel, a sequence of different sized male and female TRIANGLE SHAPES were created by COMPRESSION MOULDING: shorter (Length: 260 mm with a 9° tilt) in the top part, longer (Length: 560 mm with a 5° tilt) at the bottom part, in addition to rounded, 3 mm deep horizontal and vertical "piping". A pair of holes was drilled into every TRIANGLE. When a pair of male and female TRIANGLES are overlapped and their holes lined up (locked into place by two metal plates), the FLAT panel turns into a HEMISPHERICAL panel.

**PLATES TO FIX THE FRONT PANEL TO THE DESKTOP**

The FRONT PANEL is attached to the DESKTOP by means of 5 mm-thick shaped metal brackets, with epoxy powder-coated finish of Ral 9016 matte White. They come in two versions: FOR WELCOME OVERHEAD SHELF and WITHOUT WELCOME OVERHEAD SHELF

There are three FUNNY SAT WELCOME configurations available:

- **NO PROVISION FOR TOP:** The brackets can only be used to attach the panel to the desktop.
- **PROVISION FOR A WELCOME OVERHEAD SHELF:** The brackets can be used to attach the panel to the desktop whether it is to the right or the left of a WELCOME OVERHEAD SHELF (the position is decided when assembling).
- **PROVISION FOR TWO WELCOME OVERHEAD SHELVES:** The brackets can be used to attach the front panel to the desk top even when there are TWO WELCOME OVERHEAD SHELVES.

**WELCOME OVERHEAD SHELF**

Made from 18 mm-thick MDF with rounded corners and shaped edge, available with lacquered matte finish (in ORANGE, GREEN, SKY BLUE AND SAND).

**UNDER-DESK UTILITY DRAWER**

Made from 40 mm-thick MDF with rounded corners and shaped edge, available with lacquered matte finish (in ORANGE, GREEN, SKY BLUE AND SAND). The drawer comes in left or right mounting version. It is complete with lock fitted with Zamak cap coated with Ral 9016 matte White finish. The drawer is attached to the top by means of a metal pin for smooth, silent rotation (a Black Teflon grommet is inserted between pin and drawer). The system comes with a system to block the drawer in opening and closing position.

**SUSPENDED CPU HOLDER**

**SLIM model** Made from sheet metal, with epoxy powder-coated finish in Ral 9016 matte White. Height adjustment from 20 to 35.8 cm. Width adjustment from 5 to 10 cm. Depth adjustment from 12.5 to 36 cm. Maximum CPU weight - 12 Kg. Comes with lock.

**BIG model** Made from sheet metal, with epoxy powder-coated finish in Ral 9016 matte White. Height adjustment from 37.7 to 53.2 cm. Width adjustment from 7.8 to 22 cm. Maximum CPU weight - 15 Kg.

Modèle **WELCOME** composé de :

**PLAN DE TRAVAIL en MÉLAMINÉ**

Plans de travail en bois aggloméré de 30 mm d'épaisseur, avec une densité d'environ 650 kg/m<sup>3</sup> ; revêtement en mélaminé sur les deux côtés (grammage papier : 120 g/m<sup>2</sup>) ; traitement anti-rayures et antireflet. Finition disponible : **Béton Taloché**.  
Le panneau est muni de la certification forestière FSC, labellisé EPF-S et est conforme aux normes UNI.  
Le panneau a une bonne résistance à la flexion et à la traction et une excellente résistance au vieillissement et aux taches. Les chants sur le pourtour sont en ABS, collés avec de la colle polyuréthane et arrondis. Le panneau de série est classé en catégorie 2 pour ce qui concerne la réaction au feu.

**PIED MÉTALLIQUE À HAUTEUR FIXE (variante commerciale FIXED)**

Pied métallique composé d'une colonne verticale en métal tubulaire de section rectangulaire 200x150xép.4 mm et d'une base galbée en tôle de 6 mm d'épaisseur. Peint avec des poudres époxy couleur Blanc mat RAL9016.  
La plaque métallique soudée dans la partie supérieure de la colonne sert pour la fixation au plateau. La base est munie de feutres pour une adhérence au sol.

**PIED MÉTALLIQUE AVEC RÉGLAGE CONTINU ET MOTORISÉ DE LA HAUTEUR À DEUX ÉTAGES, DE 72 À 115 CM**

Pied métallique composé d'une colonne verticale externe FIXE, d'une colonne de levage INTERNE TÉLESCOPIQUE et MOTORISÉE, et d'une base galbée en tôle de 6 mm d'épaisseur. La colonne EXTERNE et la BASE sont peintes avec des poudres époxy de couleur Blanc mat RAL9016.  
La colonne interne télescopique est en Aluminium avec finition Anodisé Argent Naturel.

Le système de **RÉGLAGE EN HAUTEUR** est **LINAK** et présente les caractéristiques suivantes :

- Système composé d'une colonne à deux étages de section rectangulaire 194x147 mm.
- Paliers de glissement internes invisibles pour assurer un mouvement fluide et silencieux.
- Centrale de commande avec protection contre les surcharges électroniques avec fonction Soft Start/Stop. Consommation d'énergie en mode veille de seulement 0,1 W ; cordon d'alimentation interchangeable.
- Commande de contrôle : boîte à boutons encastrée dans le plateau avec commandes de montée et descente, disponible dans la couleur Blanc.

**PANNEAU DE FAÇADE SEMI-SPHÉRIQUE ACOUSTIQUE EN TISSU**

Le panneau SEMI-SPHÉRIQUE en matériau ACOUSTIQUE est le trait distinctif du produit.  
Le panneau est obtenu par THERMOFORMAGE d'un « sandwich » à trois couches composé comme suit :  
1. Tissue 100 % polyester FR (Trevira CS), poids 470 g/ml. Résistance au feu Italie Classe 1.  
2. Fibre de polyester, épaisseur 12 mm. Réaction au feu : Classe 1.  
3. Tissue 100 % polyester FR (Trevira CS), poids 470 g/ml. Résistance au feu Italie Classe 1.

Le panneau est conçu PLAT afin d'éviter les plis et les bulles d'air éventuels dans le tissu.  
Pour pouvoir obtenir à partir du plateau PLAT le panneau SEMI-SPHÉRIQUE il a fallu procéder à une série de MOULAGES (positifs et négatifs) TRIANGULAIRES de différentes dimensions : plus courts (longueur 260 mm avec inclinaison 9°) dans la partie supérieure, plus longs (longueur 560 mm avec inclinaison 5°) dans la partie inférieure, en plus des « cannelures » arrondies (horizontales et verticales) de 3 mm de profondeur.  
Deux trous sont effectués dans chaque TRIANGLE.  
En superposant une paire de TRIANGLES (positif et négatif) et en alignant les trous qui y sont présents (en les bloquant à l'aide de deux plaques de métal) on passe ainsi du panneau PLAT au panneau SEMI-SPHÉRIQUE.

**PLAQUES POUR FIXER LE PANNEAU DE FAÇADE AU PLATEAU DE BUREAU**

Le PANNEAU DE FAÇADE est fixé au plateau de BUREAU à l'aide de brides métalliques de 5 mm d'épaisseur, profilées et peintes avec des poudres époxy de couleur Blanc mat RAL9016. Disponibles en deux versions : POUR PLAN D'APPUI WELCOME et SANS PLAN D'APPUI WELCOME.  
FUNNY SAT WELCOME est disponible en trois versions :  
• **VERSION SANS PLAN D'APPUI** : les brides permettent seulement l'accrochage du panneau au plateau.  
• **VERSION POUR UN PLAN D'APPUI WELCOME** : les brides permettent non seulement l'accrochage du panneau au plateau mais aussi le positionnement à droite ou à gauche d'un PLAN D'APPUI WELCOME (lors de la phase de montage).  
• **VERSION POUR DEUX PLANS D'APPUI WELCOME** : les brides permettent non seulement l'accrochage du panneau de façade au plateau mais aussi le positionnement de DEUX PLANS D'APPUI WELCOME.

**PLAN D'APPUI WELCOME**

Réalisé en MDF de 18 mm d'épaisseur avec bords arrondis et chant de pourtour galbé. Disponible avec finition Laqué Mat et couleurs ORANGE, VERT, BLEU et SABLE.

**TIROIR SOUS LE PLATEAU**

Réalisé en MDF de 40 mm d'épaisseur avec bords arrondis et chant de pourtour galbé.  
Disponible avec finition Laqué Mat, couleurs ORANGE, VERT, BLEU et SABLE. Le tiroir, disponible en version à Droite ou à Gauche, est muni de serrure avec clé et couvre-clé en Zamak peint de couleur Blanc Mat RAL9016. Le tiroir est fixé au plateau à l'aide d'une tige métallique pour rendre la rotation fluide et silencieuse (une bague en Téflon de couleur noire est insérée entre la tige et le tiroir).  
Le système est muni d'une butée d'ouverture et de fermeture.

**SUPPORT UC SUSPENDU**

**Modèle SLIM** réalisé en tôle pliée peinte avec des poudres époxy de couleur Blanc mat RAL9016. Possibilité de réglage en hauteur de 20 à 35,8 cm, en largeur de 5 à 10 cm et en profondeur de 12,5 à 36 cm. Poids maximum UC : 12 kg. Avec serrure.  
**Modèle BIG** réalisé en tôle pliée peinte avec des poudres époxy de couleur Blanc mat RAL9016. Possibilité de réglage en hauteur de 37,7 à 53,2 cm et en largeur de 7,8 à 22 cm. Poids maximum UC : 15 kg.

RCD file information

003659648-0001

Graphic representation



1 / 2

Design information

Design number	<b>003659648-0001</b>	Filing language	<b>ITALIAN</b>
Name		Second language	<b>ENGLISH</b>
Filing date	<b>19/01/2017</b>	Reference	
Registration date	<b>19/01/2017</b>	Vienna Classification	
Expiry date	<b>19/01/2022</b>	Verbal element	
Design status	<b>Registered and fully published (A.1.)</b>		

Indication of the product, [\(Eurolocarno\)](#)

Locarno	<b>06.06</b>	English
Values	<b>Furniture panels, Writing desks (Accessories for -)</b>	

Owners

IVM S.p.A.

ID	<b>806772</b>	Country	<b>IT - Italy</b>	Correspondence address	Can be accessed and changed by authorised user via the User Area
Organisation	<b>IVM S.p.A.</b>	State/county	<b>n/a</b>	IVM S.p.A.	
Legal status	<b>Legal entity</b>	Town	<b>Lissone (MB)</b>	Via C. Cattaneo, 90	Can be accessed and changed by authorised user via the User Area
		Post code	<b>20851</b>	I-20851 Lissone (MB)	
		Address	<b>Via C. Cattaneo, 90</b>	ITALIA	

# I\_BENCH

DESIGN by STUDIO IVM



I\_BENCH

**NEW**

**NEW FINISHES**

<b>PIANI</b> TOP PLATEAUX	<b>GRAFITE</b> GRAPHITE
	<b>CANAPA</b> WARM GREY_CHANVRE
	<b>VISONE</b> MOSS GREY_VISON
	<b>OTTANIO</b> PETROL GREEN_VERT PÉTROLE
<b>STRUTTURA</b> STRUCTURE	<b>CANAPA</b> WARM GREY_CHANVRE
	<b>VISONE</b> MOSS GREY_VISON
	<b>NERO</b> BLACK_NOIR

Mantenendo inalterate  
l'essenzialità  
del disegno  
e la 'pulizia' formale  
che caratterizzano

le collezioni **FLY&WING...**

un coerente sviluppo  
di progetto in grado  
di interpretare con  
la stessa leggerezza  
lo spazio\_ufficio  
operativo...





Maintaining  
the essential nature  
of the design  
and the formal,  
"clean-cut" approach  
enjoyed throughout  
the FLY and WING  
collections...  
this is I\_BENCH.



A coherent  
development  
of the project,  
able to interpret  
functional office  
space with the  
same "lightness".



Postazioni operative  
caratterizzate  
sul piano estetico  
da finiture ricercate,  
disegno essenziale e  
dimensioni contenute,  
che integrano  
tutte le dotazioni  
tecnologiche  
necessarie.

Functional workstations  
featuring refined  
aesthetic finishes,  
essential design  
and compact dimensions,  
integrating all  
the technological  
features required.

## I\_BENCH



ALL  
you  
need is  
LESS



LESS  
is MORE,  
WHAT  
else?



Spessori  
essenziali.  
Forme  
minimali.



I\_BENCH MEETING



only  
'FRAME'  
top  
thickness  
LESS

# Creating exceptional spaces



360x<sup>146</sup>











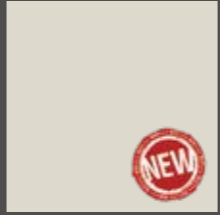



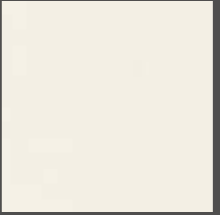

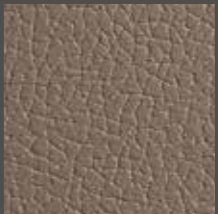
**MEETING**  
Il sistema modulare.  
The modular system.  
Le système modulable.

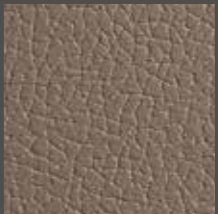

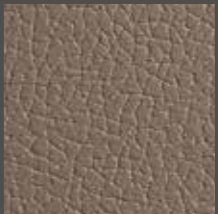
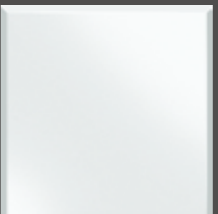

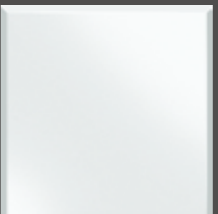
only  
'FRAME'  
top  
thickness  
LESS

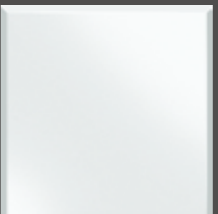



**I\_BENCH** \_FINITURE PIANI  
\_TOP FINISHES  
\_FINITIONS DE PLATEAUX

						<b>NOBILITATO</b> LAMINATE MÉLAMINÉ						
CANAPA WARM GREY / CHANVRE	VISONO MOSS GREY / VISON	OTTANIO PETROL GREEN / VERT PÉTROLE	GRAFITE GRAPHITE	AVORIO IVORY / IVOIRE	NOCE WALNUT / NOYER							
<p><i>Per una corretta valutazione di tonalità e colore delle diverse finiture rappresentate a catalogo, è necessario fare riferimento ai campioni fisici.</i></p> <p><i>Due to variances in printed colours, see the swatches for the actual colours and shades of the different finishes.</i></p> <p><i>Pour une évaluation correcte du ton et de la couleur des différentes finitions représentées dans le catalogue, il est nécessaire de se référer aux échantillons physiques.</i></p>						<b>PRIMOFIORE</b>						
<table border="0"> <tr> <td></td> <td></td> </tr> <tr> <td>PANNA CREAM / CRÈME</td> <td>TORTORA</td> </tr> </table>									PANNA CREAM / CRÈME	TORTORA		
												
PANNA CREAM / CRÈME	TORTORA											
<table border="0"> <tr> <td></td> <td></td> <td></td> </tr> <tr> <td>EXTRALIGHT BIANCO EXTRALIGHT WHITE / BLANC EXTRA-CLAIR</td> <td>MOKA</td> <td>NERO BLACK / NOIR</td> </tr> </table>									EXTRALIGHT BIANCO EXTRALIGHT WHITE / BLANC EXTRA-CLAIR	MOKA	NERO BLACK / NOIR	<b>CRISTALLO LACCATO</b> LACQUERED GLASS VERRE LAQUÉ
												
EXTRALIGHT BIANCO EXTRALIGHT WHITE / BLANC EXTRA-CLAIR	MOKA	NERO BLACK / NOIR										
						<p><i>Disponibile solo per I_Bench Meeting.</i> <i>Available only for I_Bench Meeting.</i> <i>Seulement disponible pour I_Bench Meeting.</i></p>						

**I\_BENCH** \_FINITURE STRUTTURA  
\_STRUCTURE FINISHES  
\_FINITIONS DE LA STRUCTURE

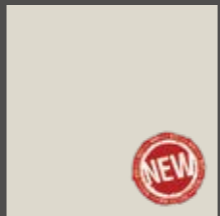
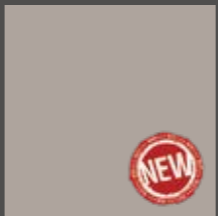
						
CANAPA WARM GREY / CHANVRE	VISONO MOSS GREY / VISON	NERO BLACK / NOIR	BRUNO OLIVA OLIVE BROWN / OLIVE BRUN	PELTRO PEWTER / ÉTAIN	BIANCO WHITE / BLANC	BRILL

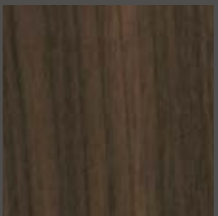
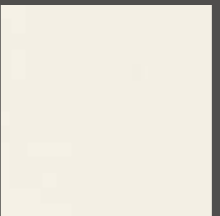
**I\_BENCH** \_FINITURE PONTE  
\_BRIDGE FINISHES  
\_FINITIONS DU PONT

						<b>NOBILITATO</b> LAMINATE MÉLAMINÉ
CANAPA WARM GREY / CHANVRE	VISONO MOSS GREY / VISON	PENELOPE SABBIA PENELOPE SAND / PENELOPE SABLE	OLMO TESTA DI MORO ELM DARK BROWN / ORME FONCÉ	AVORIO IVORY / IVOIRE	SPATOLATO CEMENTO CEMENT RENDER EFFECT BÉTON TALOCHÉ	



## I\_BENCH PROF.80

L. 140 MODULO PIANO / DESK TOP MODULE | H. 73

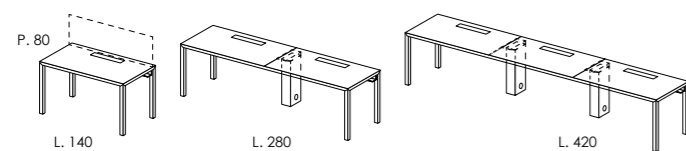

L. 160 MODULO PIANO / DESK TOP MODULE / MODULE | H. 73

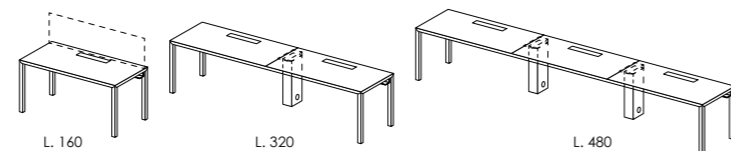

L. 180 MODULO PIANO / DESK TOP MODULE | H. 73

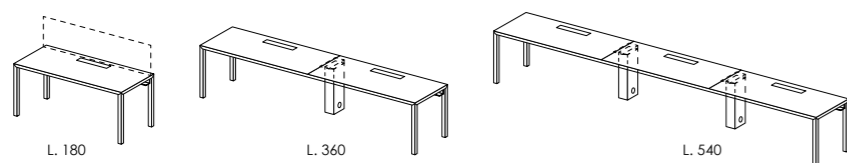

L'AGGREGAZIONE / COMPOSITION

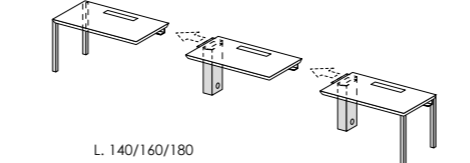

## I\_BENCH PROF.146

L. 160 MODULO PIANO / DESK TOP MODULE | H. 73

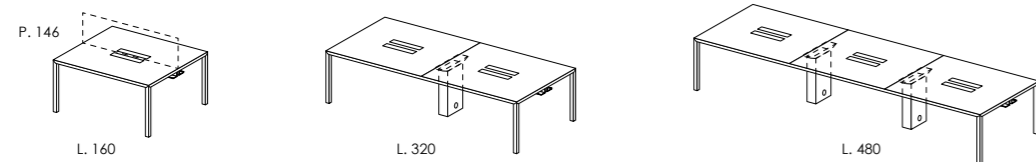

L. 180 MODULO PIANO / DESK TOP MODULE | H. 73

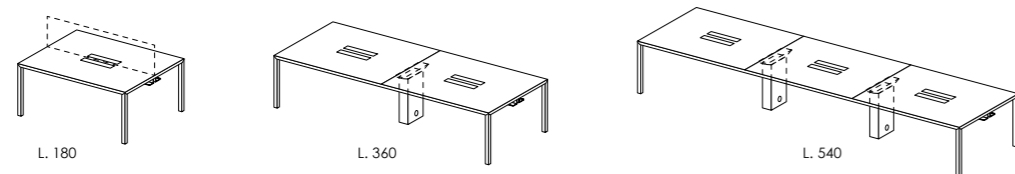

L. 200 MODULO PIANO / DESK TOP MODULE | H. 73

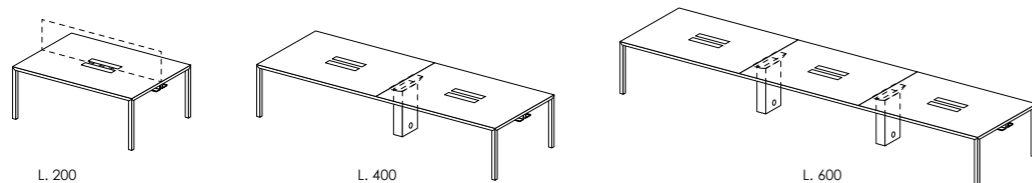

L. 278 MODULO PIANO / DESK TOP MODULE | H. 73

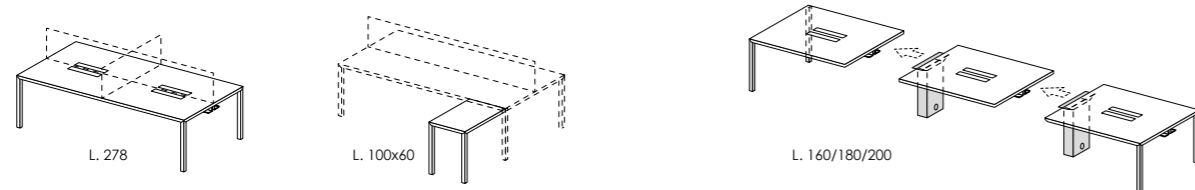

L'AGGREGAZIONE / COMPOSITION

## I\_BENCH MEETING PROF.146

L. 160 MODULO PIANO / DESK TOP MODULE | H. 73

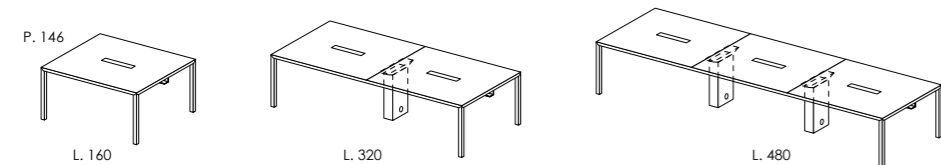

L. 180 MODULO PIANO / DESK TOP MODULE | H. 73

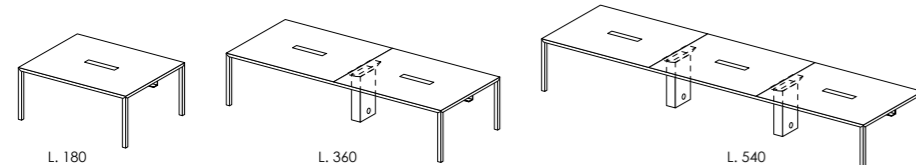

L. 200 MODULO PIANO / DESK TOP MODULE | H. 73

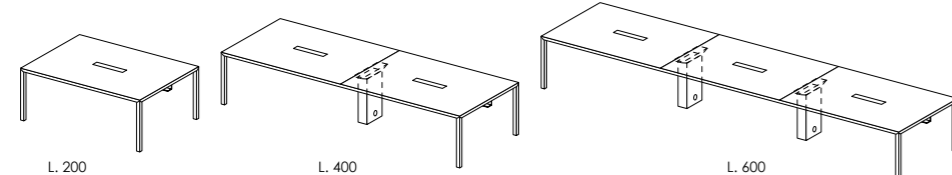

## CONTENITORI SU RUOTE

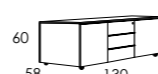

## I\_BENCH \_SPECIFICHE TECNICHE /N TECHNICAL SPECIFICATIONS / SPÉCIFICATIONS TECHNIQUES

### I\_BENCH prof.80\_prof.146\_MEETING

#### PIANI

I piani, realizzati in TAMBURATO LIGNEO spessore mm 50, sono disponibili nelle finiture NOBILITATO AVORIO, NOCE, Pelle Primofiore (nelle varianti PANNA o TORTORA), GRAFITE, CANAPA, VISIONE e OTTANIO.

Solo per la versione I\_BENCH MEETING disponibili piani in CRISTALLO retroLACCATO nei colori NERO, MOKA ed EXTRALIGHT BIANCO.

Lungo tutto il perimetro dei piani è applicato un PROFILO in ALLUMINIO spessore 3.5 mm con spigoli arrotondati in FINITURA BRILL, BIANCO, PELTRO, BRUNO OLIVA, CANAPA, VISIONE o NERO.

I piani in cristallo (per la versione I\_BENCH MEETING) in spessore mm 5 SONO APPOGGIATI SU UN PIANO IN TAMBURATO LIGNEO spessore mm 46 e presentano bordi perimetrali con spigoli smussati.

#### STRUTTURA

La struttura portante dei piani è costituita da gambe in estruso di alluminio sezione 50x50 nelle finiture BRILL, BIANCO, PELTRO, BRUNO OLIVA, CANAPA, VISIONE e NERO (con piedino regolabile in colore nero).

Nella parte superiore è agganciata una piastra a "L" in metallo spessore mm 6 verniciata con polveri epossidiche COLOR SILVER.

**Tutti i materiali utilizzati sono conformi alle norme UNI EN e sono certificati per il 90% CARB 2 (relativamente all'emissione di formaldeide).**

### I\_BENCH depth 80\_depth 146\_MEETING

#### TOPS

The tops, created from 50 mm thick HOLLOW CORE WOOD are available in the finishes IVORY, WALNUT, Pelle Primofiore (CREAM and TORTORA variants), GRAPHITE, Warm Grey, Moss Grey or Petrol Green LAMINATE.

Only for the I-BENCH MEETING version, are GLASS tops available, retro-LACQUERED in BLACK, MOKA and EXTRALIGHT WHITE.

Along the entire perimeter of the tops, a 3.5 mm thick ALUMINIUM PROFILE is applied, with rounded corners in a BRILL, WHITE, PEWTER, OLIVE BROWN, WARM GREY, MOSS GREY or BLACK FINISH.

The 5 mm thick glass tops (for the I\_BENCH MEETING version) REST ON A 46 mm thick HOLLOW CORE WOOD TOP, with rounded corner perimeter edging.

#### STRUCTURE

The structure supporting the tops consists of extruded aluminium legs with a 50 x 50 section in BRILL, WHITE, PEWTER, OLIVE BROWN, WARM GREY, MOSS GREY and BLACK finishes (with adjustable black feet).

An 'L'-shaped plate in 6 mm thick metal is hooked to the top part, finished in SILVER-COLOURED, epoxy powder paint.

**All materials used comply with UNI EN standards, and 90% of its production is certified to CARB 2 (formaldehyde emissions).**

### I\_BENCH prof.80\_prof.146\_MEETING

#### PLATEAUX

Les plateaux réalisés avec un PANNEAU DE BOIS À ÂME CREUSE d'une épaisseur de 50 mm, sont disponibles dans les finitions suivantes : MÉLAMINÉ IVOIRE, NOYER, PELLE PRIMOFIORE (dans les couleurs CRÈME et TORTORA), GRAPHITE, CHANVRE, VISON ou VERT PÉTROLE.

Uniquement pour la version I\_BENCH MEETING, des plateaux sont disponibles en VERRE LAQUÉ dans les coloris NOIR, MOKA et BLANC EXTRALIGHT. Un PROFIL en ALUMINIUM d'une épaisseur de 3.5 mm avec des arêtes arrondies dans la FINITION BRILL, BLANC, ÉTAIN, OLIVE BRUN, CHANVRE, VISON ou NOIR est appliqué sur tout le pourtour des plateaux.

Les plateaux en verre (pour la version I\_BENCH MEETING) de 5 mm d'épaisseur SONT POSÉS SUR UN PLATEAU EN PANNEAU DE BOIS À ÂME CREUSE d'une épaisseur de 46 mm et ils présentent des bords à arêtes émoussés sur le pourtour.

#### STRUCTURE

La structure portante des plateaux est constituée de pieds en extrudé d'aluminium section 50x50 dans les finitions BRILL, BLANC, ÉTAIN, OLIVE BRUN, CHANVRE, VISON et NOIR (avec pied réglable de couleur noire).

Dans la partie supérieure est accrochée une plaque métallique en « L » d'une épaisseur de 6 mm, peinte avec des poudres époxy COULEUR SILVER.

**Tous les matériaux employés sont conformes aux normes UNI EN et sont certifiés CARB 2 (concernant l'émission de formaldéhyde) pour 90 % de la production.**

# SISTEMI INTEGRATI

DESIGN by PERIN&TOPAN

**SISTEMI INTEGRATI:**  
una straordinaria FLESSIBILITÀ.

In virtù del principio di LIBERTÀ  
e di apertura che anima  
il pensiero di ogni progetto.

**INTEGRATED SYSTEMS:**  
unparalleled FLEXIBILITY.

FREEDOM driving  
the concept  
of every design.

**BUREAUX INTÉGRÉS:**  
une FLEXIBILITÉ extraordinaire.

En vertu du principe de LIBERTÉ  
et d'ouverture qui anime  
la pensée de chaque projet.

## 3 SISTEMI OPERATIVI

ARKO\_KOSMOS\_KS•LIGHT  
perfettamente integrabili tra loro  
per tecnologia, finiture e progettualità

## TRASVERSALE ai 3 SISTEMI

ARKO\_KOSMOS\_KS•LIGHT

### IL SISTEMA PONTE:

la funzionalità e il "benessere"  
di uno spazio "singolo"  
con la logica di ottimizzazione  
degli spazi delle  
postazioni condivise.

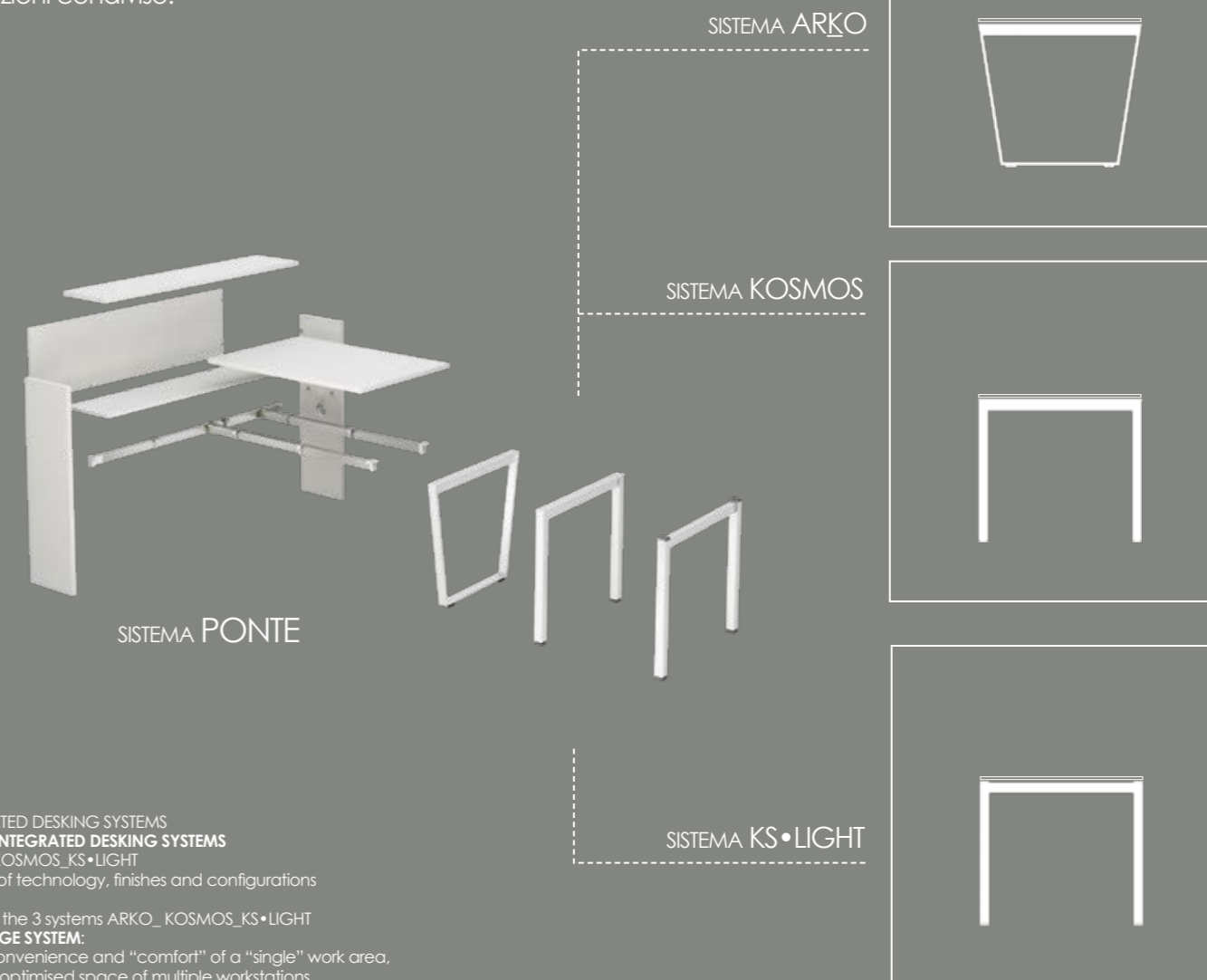

INTEGRATED DESKING SYSTEMS  
**3 FULLY INTEGRATED DESKING SYSTEMS**  
ARKO\_KOSMOS\_KS•LIGHT  
in terms of technology, finishes and configurations

**ACROSS** the 3 systems ARKO\_KOSMOS\_KS•LIGHT  
**THE BRIDGE SYSTEM:**  
all the convenience and "comfort" of a "single" work area,  
with the optimised space of multiple workstations

BUREAUX OPÉRATIONNELS INTÉGRÉS  
soit: **3 BUREAUX OPÉRATIONNELS**  
ARKO\_KOSMOS\_KS•LIGHT  
parfaitement intégrables entre eux au niveau de la  
technologie, des finitions et de la conception.

Conçu pour **INTÉGRER** les 3 systèmes  
ARKO\_KOSMOS\_KS•LIGHT  
**LE SYSTÈME PONT:**  
la fonctionnalité et le « bien-être » d'un espace « individuel »,  
dans une logique d'optimisation des espaces  
des postes de travail partagés.



La struttura portante del SISTEMA PONTE "comunica" indifferentemente con i 3 sistemi operativi integrati: ARKO, KOSMOS, KS•LIGHT.

The structure of the BRIDGE SYSTEM "communicates" with all three integrated desking systems: ARKO, KOSMOS, KS•LIGHT.

La structure portante du SYSTÈME PONT « communique » indifféremment avec les 3 systèmes opérationnels intégrés : ARKO, KOSMOS, KS•LIGHT.

NEW FINISHES	
<b>PIANI</b> TOP PLATEAUX	<b>GRAFITE</b> GRAPHITE
	<b>CANAPA</b> WARM GREY_CHANVRE
	<b>VISONE</b> MOSS GREY_VISON
<b>GAMBE</b> LEGS_PIEDS	<b>OTTANIO</b> PETROL GREEN_VERT PÉTROLE
	<b>CANAPA</b> WARM GREY_CHANVRE
	<b>VISONE</b> MOSS GREY_VISON
<b>STRUTTURA PONTE</b> BRIDGE_PONT STRUCTURE	<b>CANAPA</b> WARM GREY_CHANVRE
	<b>VISONE</b> MOSS GREY_VISON
	<b>PENELOPE ARGILLA</b> PENELOPE CLAY PENELOPE ARGILE

## IL SISTEMA PONTE

La funzionalità ed il "benessere" di uno spazio "singolo" con la logica di ottimizzazione degli spazi delle postazioni condivise.

### THE BRIDGE SYSTEM

All the convenience and "comfort" of a "single" work area, with the optimised space of multiple workstations.

### LE SYSTÈME PONT

La fonctionnalité et le « bien-être » d'un espace « individuel », dans une logique d'optimisation des espaces des postes de travail partagés.

LA MULTI-FUNZIONALITÀ	214
MULTIPURPOSE USE / LA MULTIFONCTIONNALITÉ	
LA PROGETTUALITÀ	216
CONFIGURATIONS / LA CONCEPTION	
LA TECNOLOGIA - LA STRUTTURA	222
TECHNOLOGY - STRUCTURE / LA TECHNOLOGIE - LA STRUCTURE	

# LA MULTI-FUNZIONALITÀ

MULTIPURPOSE USE  
LA MULTIFONCTIONNALITÉ

POSTAZIONE SINGOLA - GAMBA KS•LIGHT  
single workstation - KS•LIGHT leg  
poste de travail individuel - piétement KS•LIGHT

POSTAZIONE SINGOLA - GAMBA ARKO  
single workstation - Arko frame  
poste de travail individuel - piétement Arko

TAVOLO MEETING - GAMBA KOSMOS  
meeting table - Kosmos leg  
table de réunion - piétement Kosmos

POSTAZIONE CONTRAPPOSTA CON SCREEN FRONTALE  
face-to-face workstation with front privacy screen  
poste de travail vis-à-vis avec écran privatif

TAVOLO MEETING - GAMBA KOSMOS  
meeting table - Kosmos leg  
table de réunion - piétement Kosmos

POSTAZIONE SINGOLA - GAMBA KS•LIGHT  
single workstation - KS•LIGHT leg  
poste de travail individuel - piétement KS•LIGHT

POSTAZIONE SINGOLA - GAMBA ARKO  
single workstation - Arko frame  
poste de travail individuel - piétement Arko

RECEPTION CON SCRIVANIA KOSMOS  
reception with Kosmos desk  
banque d'accueil avec bureau Kosmos

La funzionalità e il "benessere" di uno spazio "singolo" con la logica di ottimizzazione degli spazi delle postazioni e delle funzioni condivise.

Ecco di seguito visualizzate 4 diverse configurazioni che rispondono a 4 diverse esigenze. Tutte sviluppate in uno spazio molto contenuto.

All the convenience and "comfort" of a "single" work area, with the optimised space of multiple workstations for teamwork.

Below are the four different configurations that respond to four specific needs. All occupying a very compact space.

La fonctionnalité et le « bien-être » d'un espace « individuel », dans une logique d'optimisation des espaces des postes de travail et des activités partagées.

4 configurations différentes qui répondent à 4 exigences bien précises sont présentées ci-dessous. Toutes sont déployées dans un espace particulièrement restreint.

4 POSTAZIONI SINGOLE

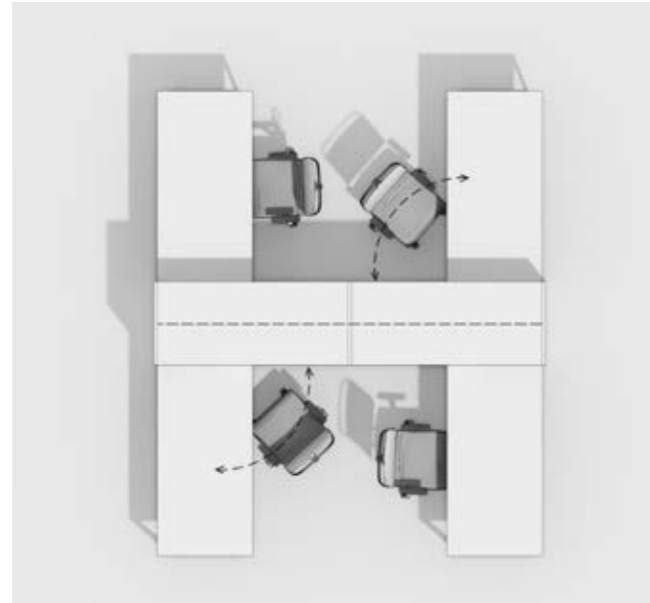

2 POSTAZIONI SINGOLE  
1 POSTAZIONE DOPPIA CON SCREEN FRONTALE

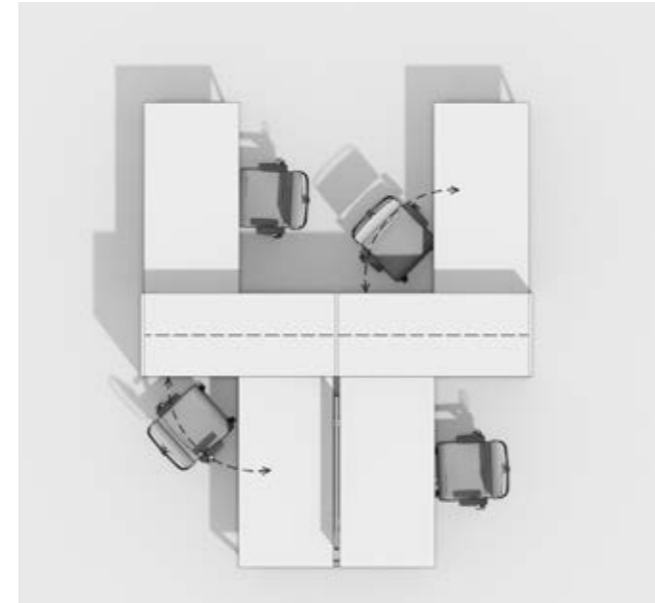

2 POSTAZIONI SINGOLE  
1 TAVOLO MEETING

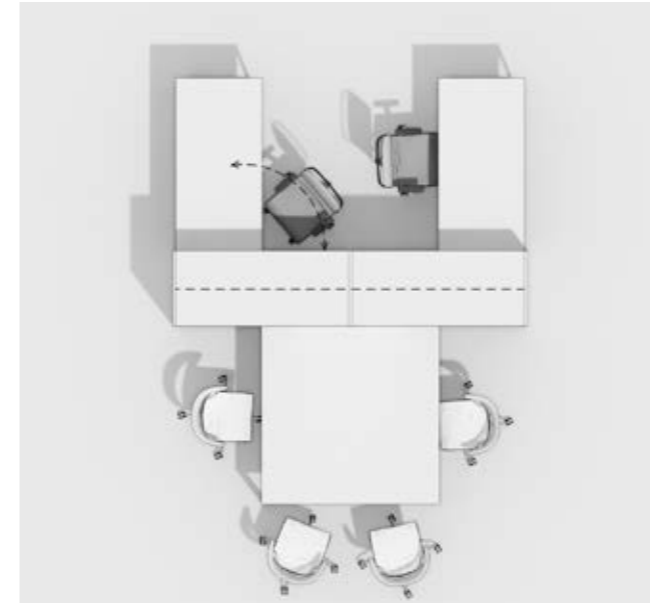

1 POSTAZIONE SINGOLA,  
1 TAVOLO MEETING  
1 RECEPTION

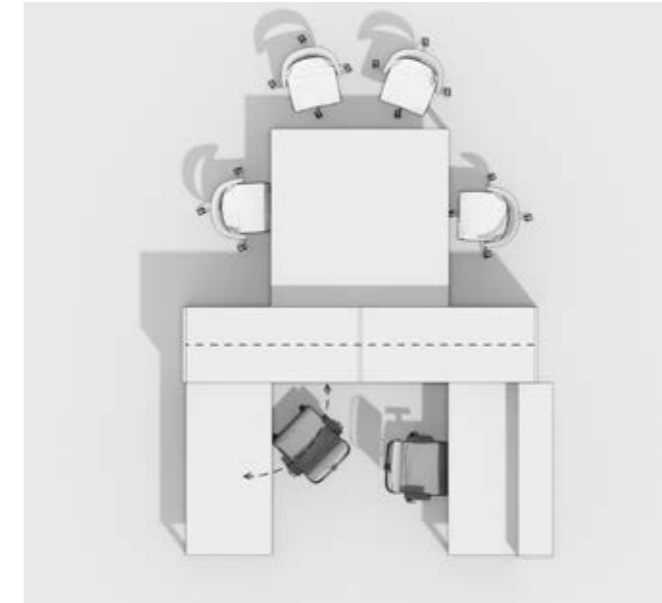

4 single workstations  
4 postes de travail individuels



2 single workstations  
1 face-to-face workstation with front privacy screen  
2 postes de travail individuels  
1 poste de travail vis-à-vis avec écran privatif



2 single workstations  
1 meeting table  
2 postes de travail individuels  
1 table de réunion

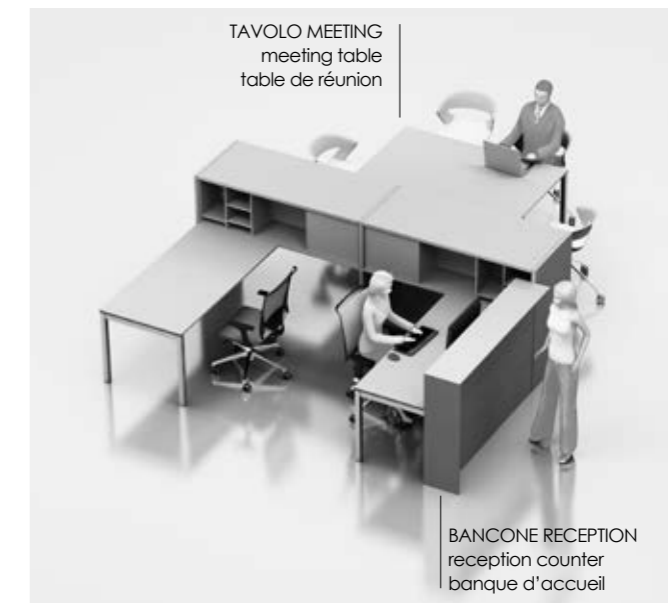

1 single workstation  
1 meeting table  
1 reception counter  
1 poste de travail individuel  
1 table de réunion  
1 banque d'accueil

Il **SISTEMA PONTE** permette di attrezzare ogni singola postazione con massima attenzione alla privacy e alla funzionalità, concretizzando al contempo una significativa ottimizzazione dello spazio.

The **BRIDGE SYSTEM** can be used to fit out each single workstation with storage units, focusing specifically on privacy and practicality, while optimising the space.

Le **SYSTÈME PONT** permet d'aménager chaque poste de travail en s'attachant particulièrement à la privatisation et à la fonctionnalité, tout en optimisant l'espace de manière concrète et significative.

2 POSTAZIONI SINGOLE IN LINEA  
1 TAVOLO MEETING

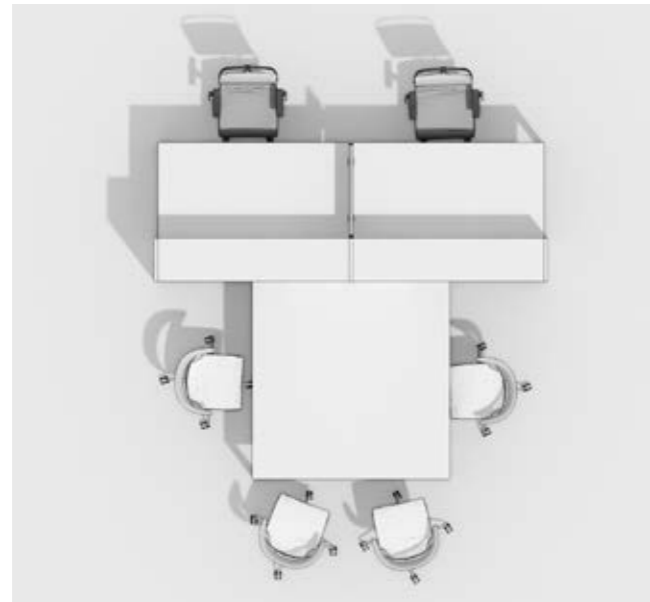

TAVOLO MEETING  
meeting table  
table de réunion

2 single, side-by-side workstations  
1 meeting table  
2 postes de travail individuels en rangée  
1 table de réunion

1 POSTAZIONE DOPPIA CON SCREEN FRONTALE

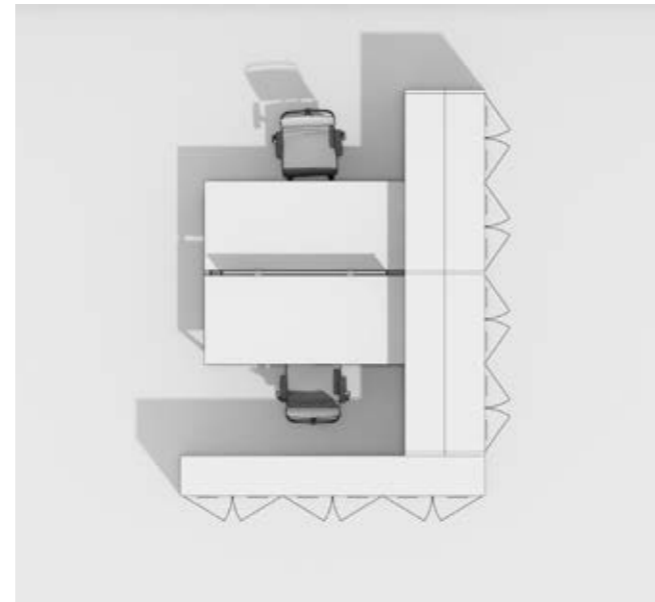

POSTAZIONE DOPPIA  
face-to-face workstation  
poste de travail vis-à-vis

1 face-to-face workstation with front privacy screen  
1 poste de travail vis-à-vis avec écran privatif

3 POSTAZIONI SINGOLE IN LINEA  
OGNI POSTAZIONE È DOTATA DI PONTE

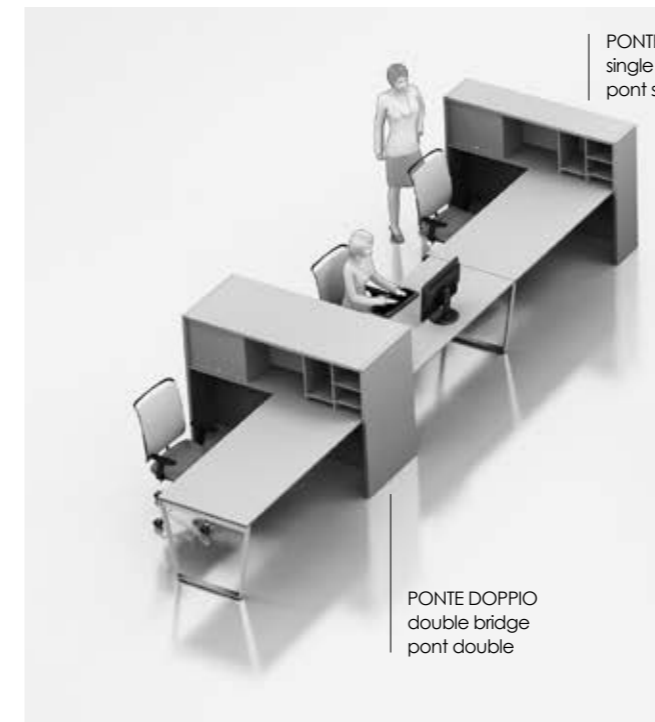
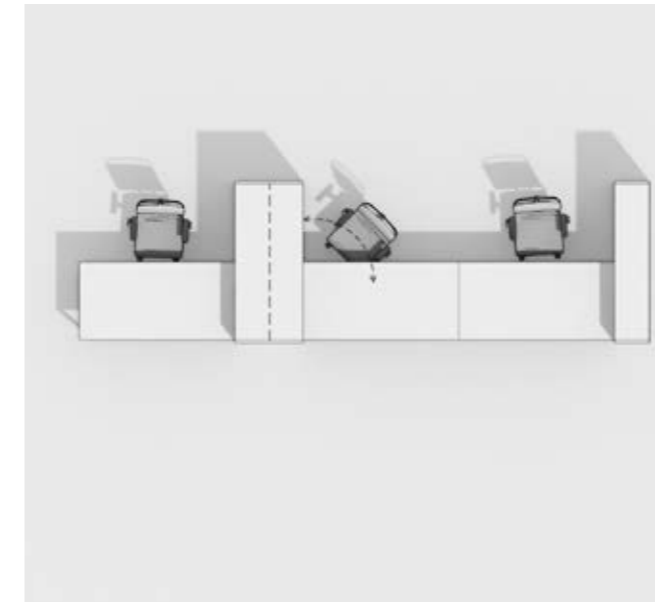

PONTE SINGOLO  
single bridge  
pont simple

PONTE DOPPIO  
double bridge  
pont double

3 side-by-side workstations  
each workstation is equipped with a bridge  
3 postes de travail en rangée,  
chaque poste est équipé d'un pont

3 POSTAZIONI DOPPIE IN LINEA  
CONTRAPPOSTE, CON SCREEN FRONTALE  
OGNI POSTAZIONE È DOTATA DI PONTE

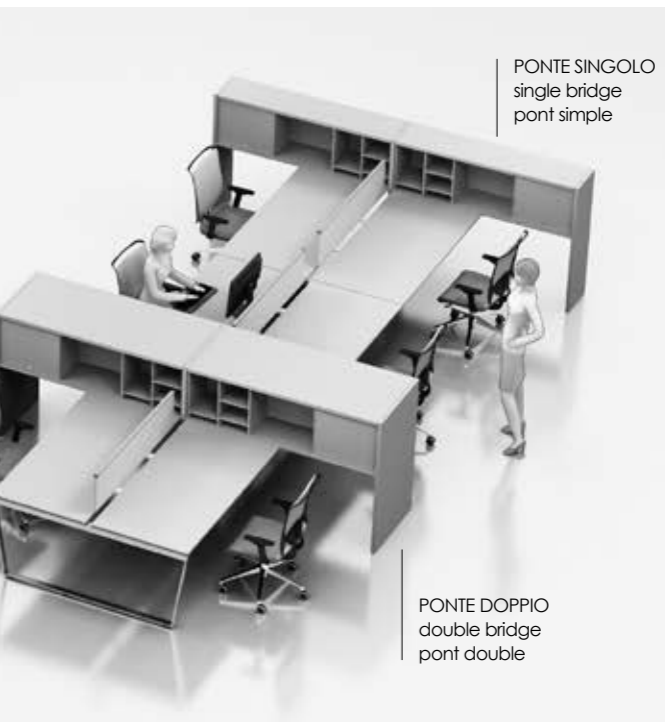
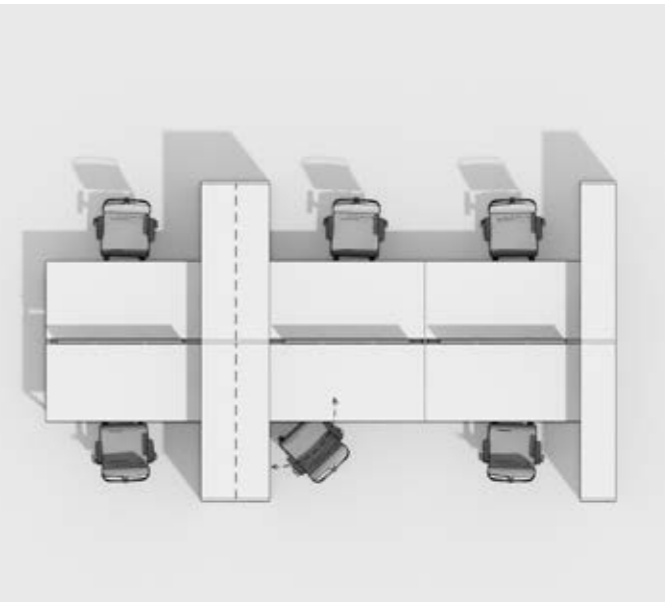

PONTE SINGOLO  
single bridge  
pont simple

PONTE DOPPIO  
double bridge  
pont double

3 face-to-face and side-by-side workstations, with frontal screen  
each workstation is equipped with a bridge  
3 postes de travail doubles vis-à-vis, en rangée, avec écran privatif,  
chaque poste est équipé d'un pont

Postazioni condivise, nella logica della moltiplicazione... a effetto domino... e dunque infinito delle situazioni e delle possibilità di impiego.  
SISTEMA PONTE: una straordinaria essenzialità modulare.

Multiple workstations with a domino effect, generating endless configurations, and a wide range of possible uses.  
BRIDGING SYSTEM: extraordinary modular simplicity.

Des postes de travail partagés, dans une logique de multiplication... à effet domino... pour des situations et des possibilités d'emploi à l'infini.  
SYSTÈME PONTE: une essentialité modulaire extraordinaire.

SVILUPPO "ISOLA 4 POSTAZIONI"  
Postazioni singole e contrapposte; ogni postazione è dotata di ponte e di elementi contenitori.

QUAD CONFIGURATION  
single and face-to-face workstations; each workstation has its own bridge and storage units.

DÉPLOIEMENT « ILÔT DE TRAVAIL 4 POSTES »  
Postes de travail individuels et vis-à-vis; chaque poste est équipé d'un pont et de modules de rangement.

SVILUPPO "ORIZZONTALE"  
DI POSTAZIONI CONTRAPPOSTE  
Ogni postazione è dotata di ponte. Gli elementi contenitori posizionati su i due lati estremi hanno funzione\_ oltrechè contenitiva\_ di definizione di un eventuale passaggio.

IN LINE CONFIGURATION  
OF FACE-TO-FACE WORKSTATIONS  
Each workstation has its own bridge. The storage units positioned at each end provide both storage space and delimit a passageway, if required.

DÉPLOIEMENT « HORIZONTAL »  
DE POSTES DE TRAVAIL VIS-À-VIS  
Chaque poste est équipé d'un pont. Les modules de rangement placés aux deux extrémités assurent une fonction de rangement et délimitent un passage éventuel.

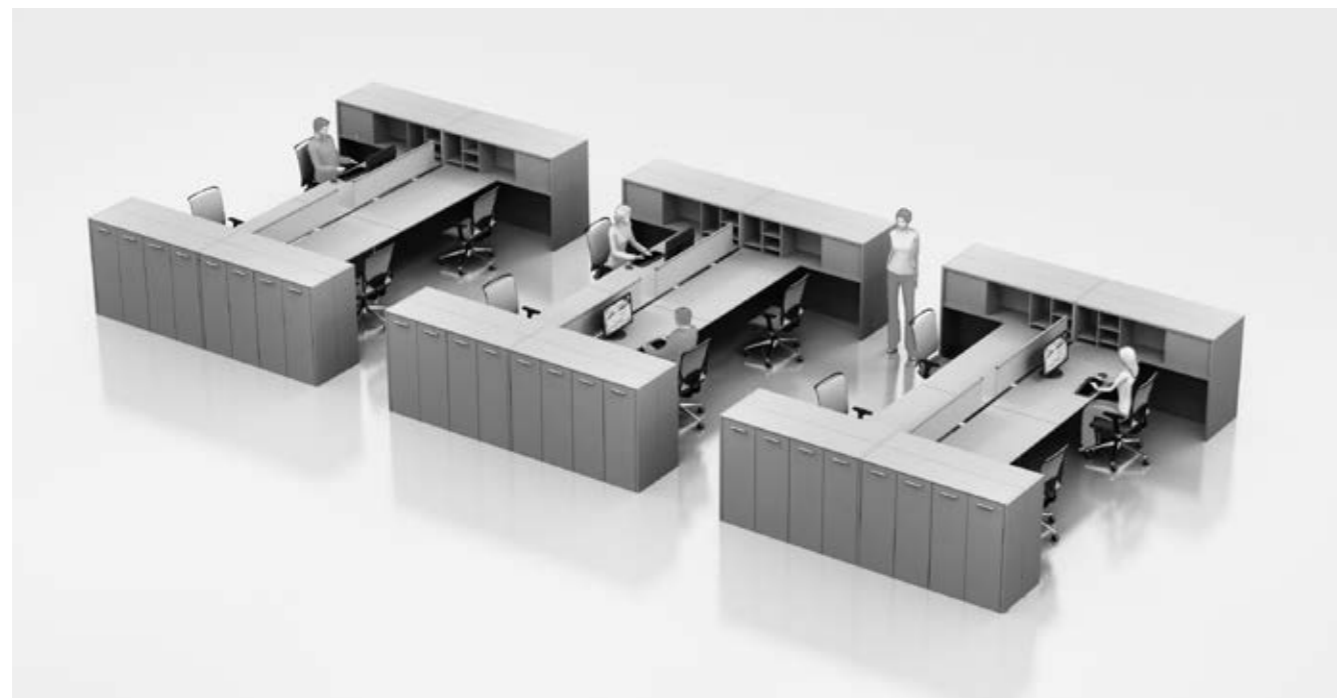
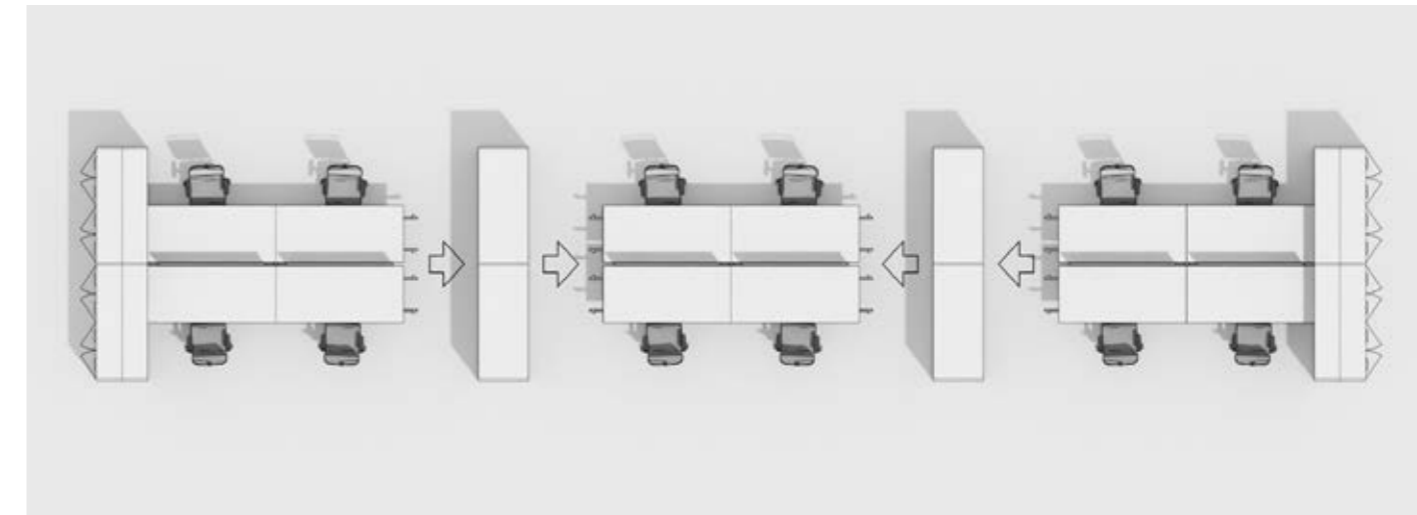
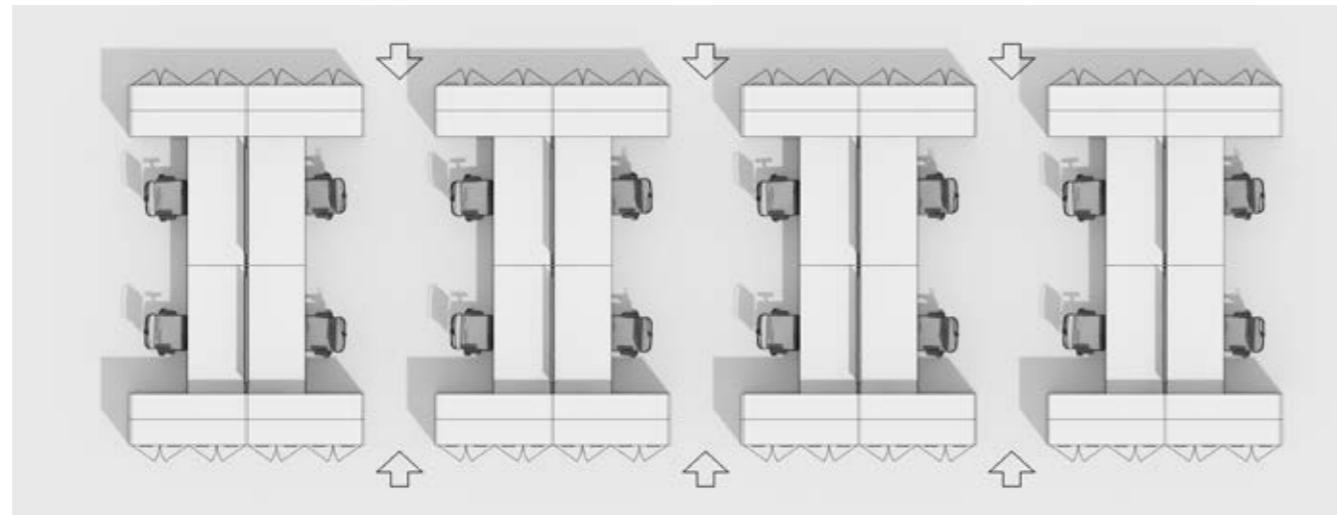



CARTER COPRICALI  
completo di 4 magneti  
CABLE CASING with 4 magnets  
CARTER CACHE-CÂBLES avec 4 aimants



VASSOIO  
PER ACCUMULO CAVI  
CABLE MANAGEMENT TRAY  
CHEMIN DE CÂBLES

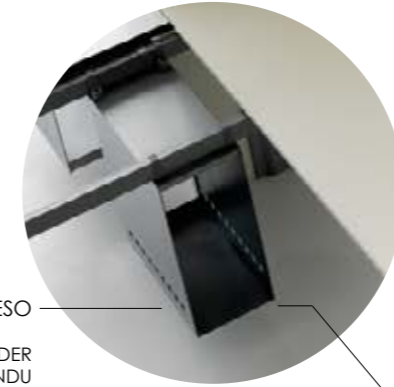

PORTA CPU SOSPESO  
SUSPENDED CPU HOLDER  
SUPPORT UC SUSPENDU

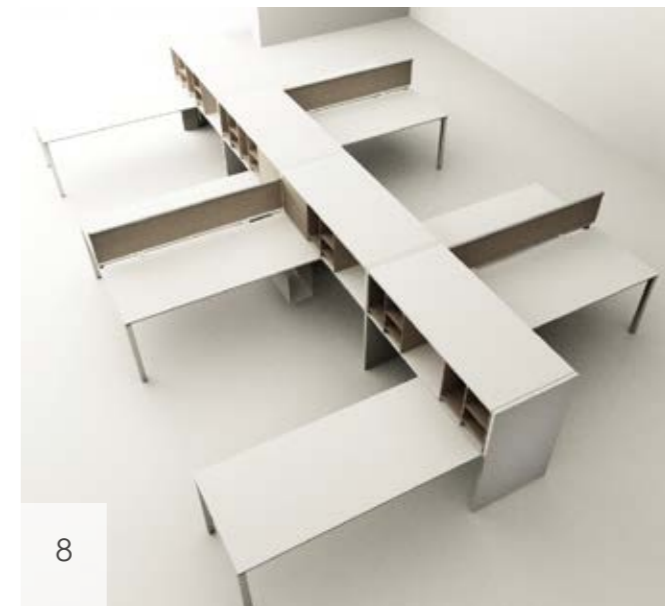
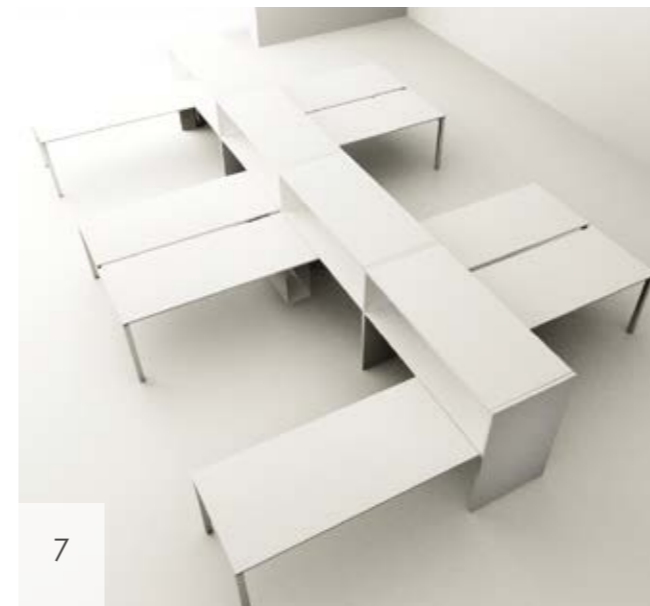
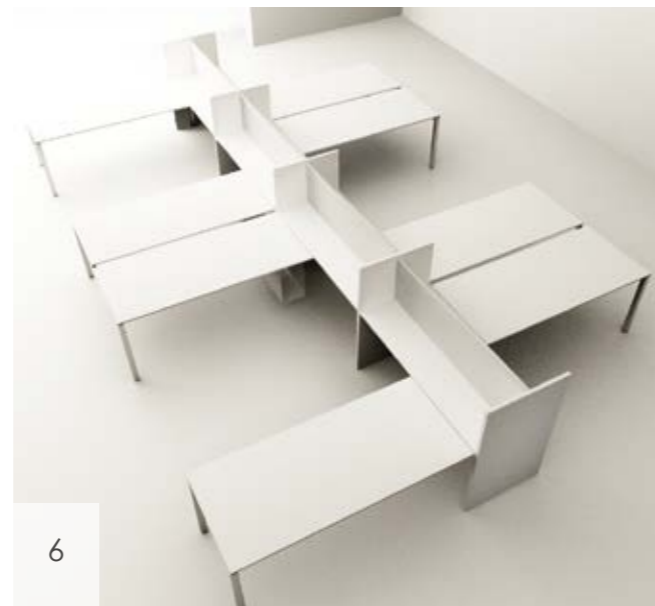
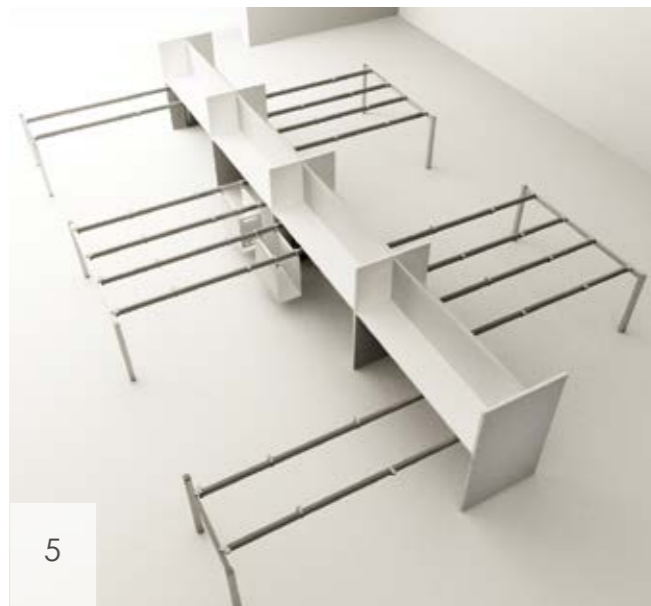
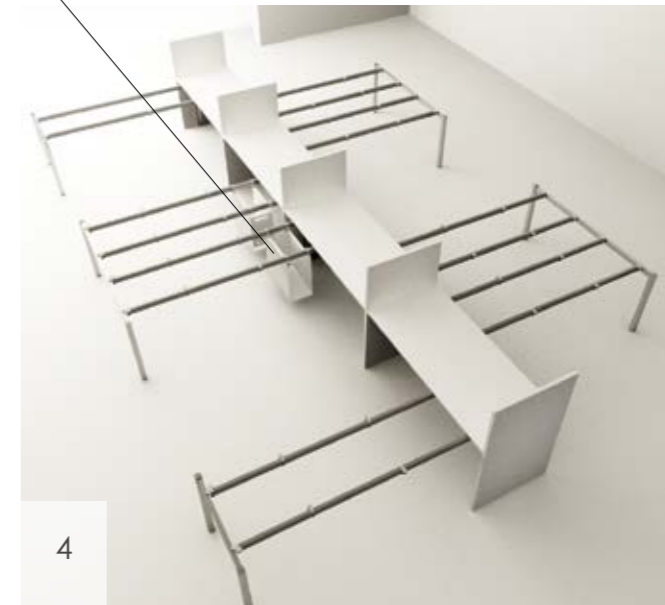
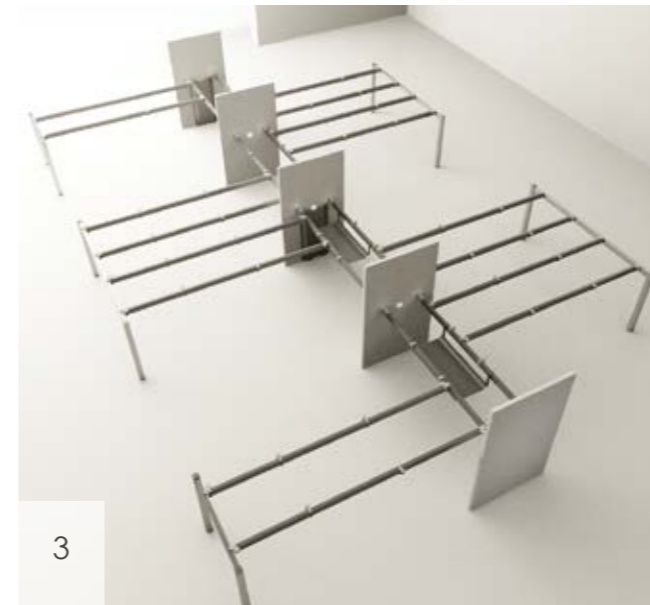
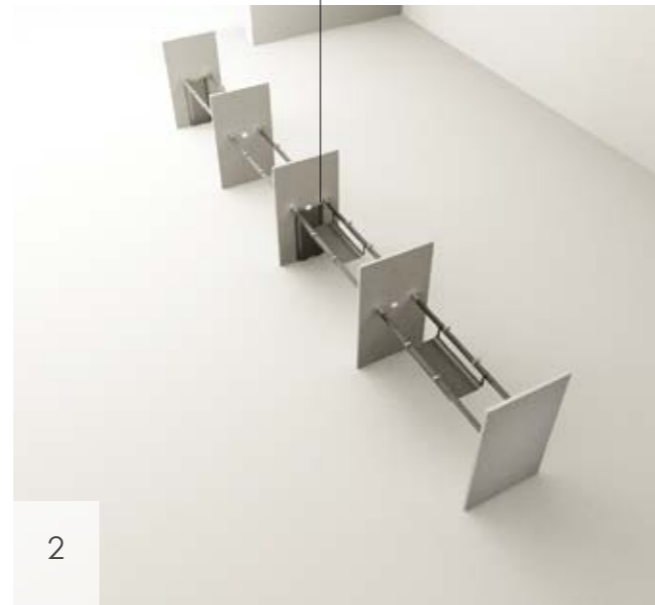
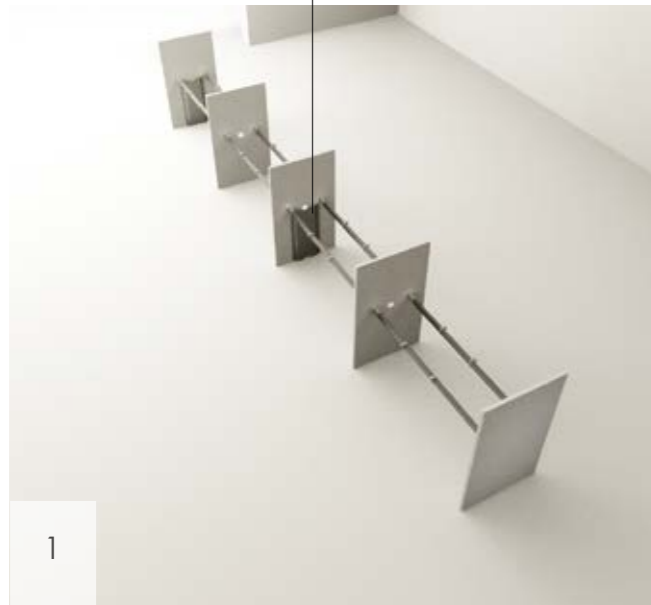





**\_PONTE h.119 singolo**

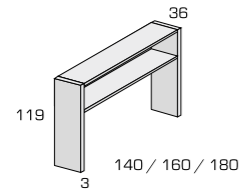

**\_PONTE h.119 doppio**

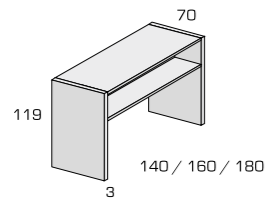

**\_ACCESSORI per ponte**

**ANTA RIBALTA**

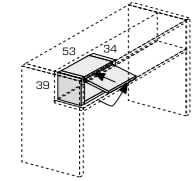

**CASELLARIO**

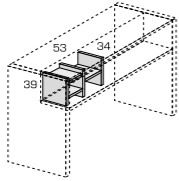

**VASSOI per accumulo cavi**

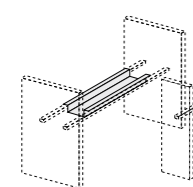

**CARTER per cavi**

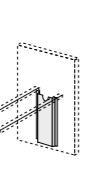



FREEDOM DRIVING THE  
CONCEPT OF EVERY DESIGN

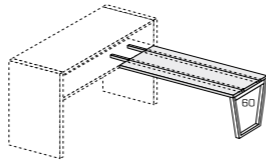

L 120 140 160 180 200  
P. 60

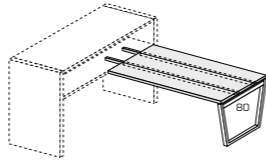

L 120 140 160 180 200  
P. 80

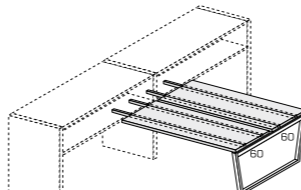

L 120 140 160 180 200  
P. 125

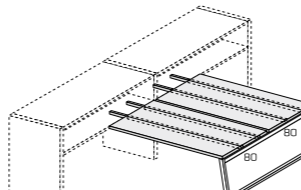

L 120 140 160 180 200  
P. 165

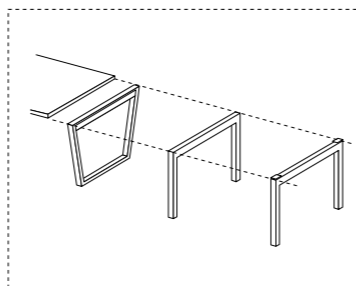



Per una completa attrezzabilità "verticale" della struttura ponte, è disponibile l'elemento con anta scorrevole. Posizionabile sotto il piano ponte; completo di serratura.

For total up-and-down fitting out of the bridge frame, a sliding door unit is also available. This can be positioned below the bridge shelf and comes with a lock.

Pour un aménagement « vertical » complet de la structure pont, un module doté d'une porte coulissante est désormais disponible. Muni d'une serrure, il se glisse sous l'étagère pont.



CARTER COPRICALI completo di 4 magneti

CABLE CASING with 4 magnets

CARTER CACHE-CÂBLES avec 4 aimants



# IL SISTEMA RECEPTION

RECEPTION SYSTEM  
SYSTEME RÉCEPTION



SISTEMA INTEGRATO **ARKO** | DESIGN by PERIN&TOPAN

	<b>NEW FINISHES</b>	
	<b>PIANI</b> TOP PLATEAUX	<b>GRAFITE</b> GRAPHITE
		<b>CANAPA</b> WARM GREY_CHANVRE
		<b>VISONE</b> MOSS GREY_VISON
		<b>OTTANIO</b> PETROL GREEN_VERT PÉTROLE
<b>GAMBE</b> LEGS_PIEDS	<b>CANAPA</b> WARM GREY_CHANVRE	
	<b>VISONE</b> MOSS GREY_VISON	

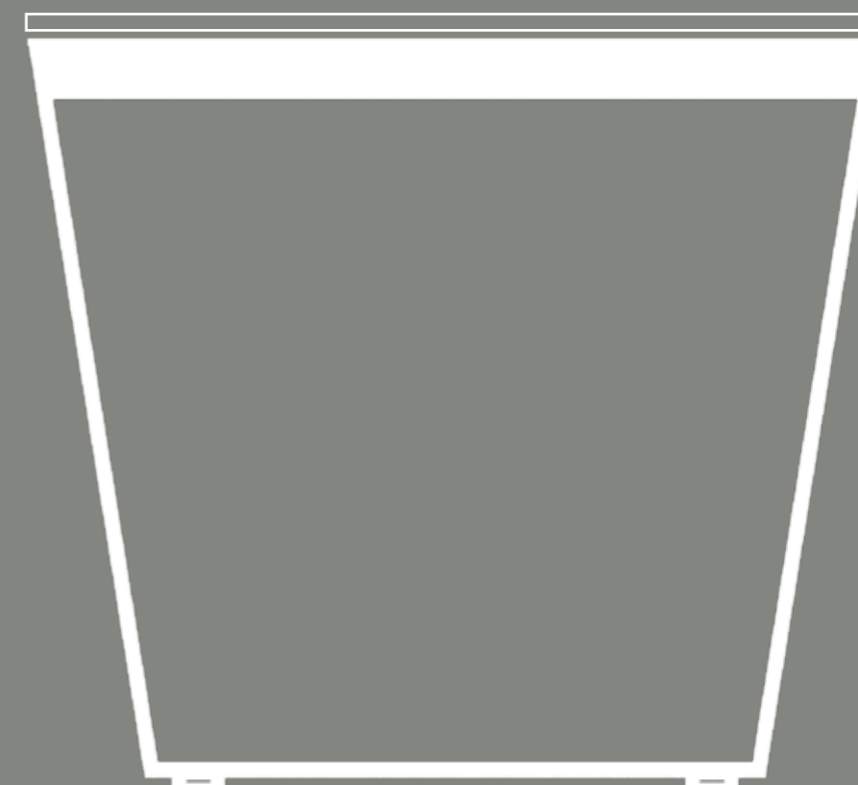



# LA PROGETTUALITÀ

CONFIGURATIONS  
LA CONCESSION

DIFFERENT WAYS OF EXPERIENCING IN THE OFFICE







ARKO







**\_SCRIVANIE LINEARI P.80**

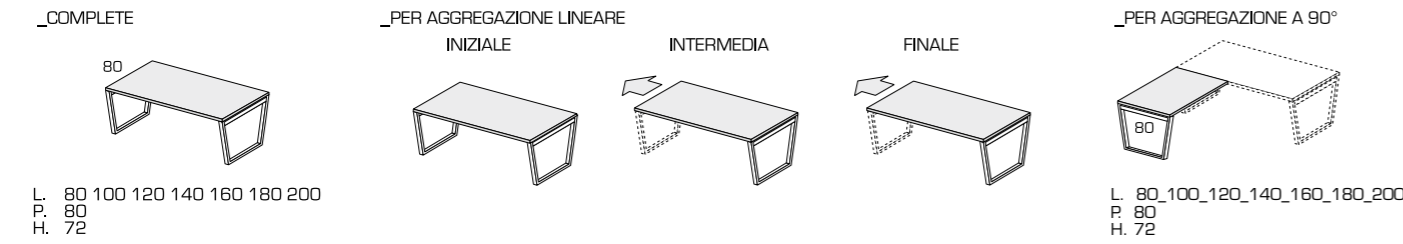

**\_SCRIVANIE LINEARI P.60**

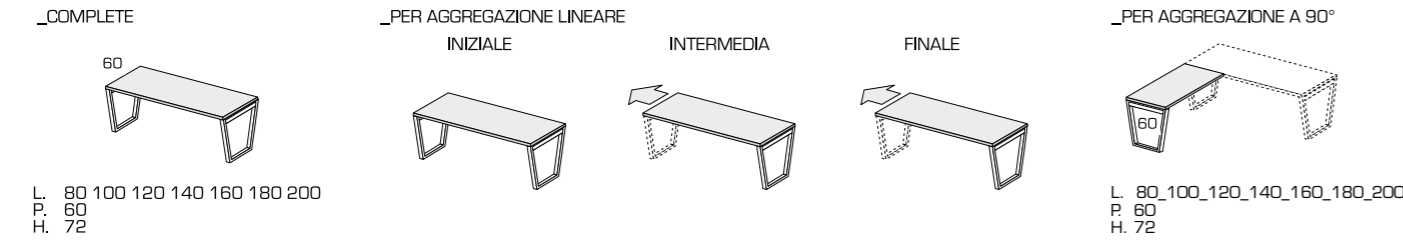

**\_SCRIVANIE DOPPIE P.165**

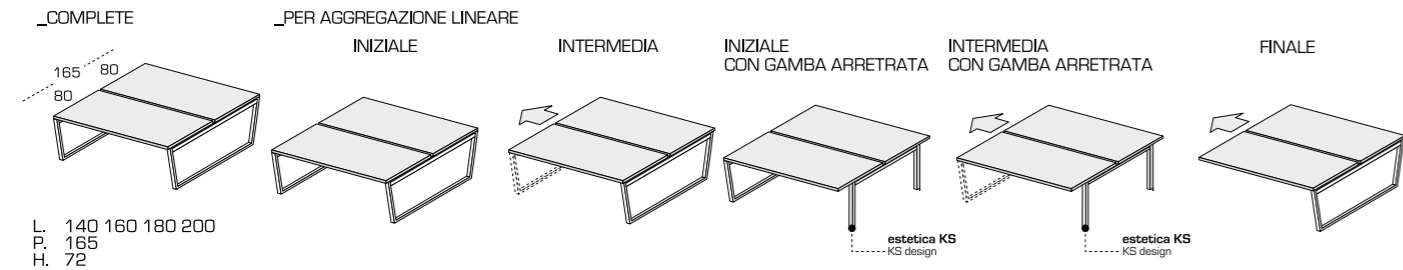

**\_SCRIVANIE LINEARI DOPPIE P.125**

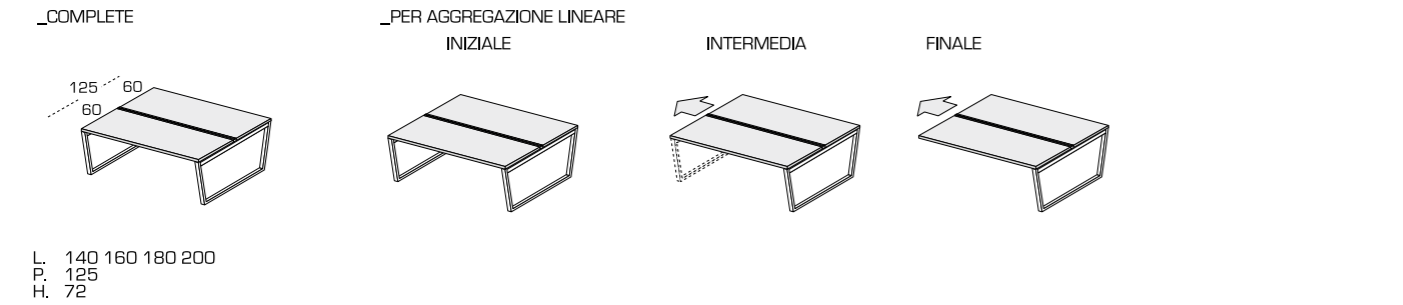

**\_SCREEN** **\_ESTRAIBILI - H.72\_H.119**

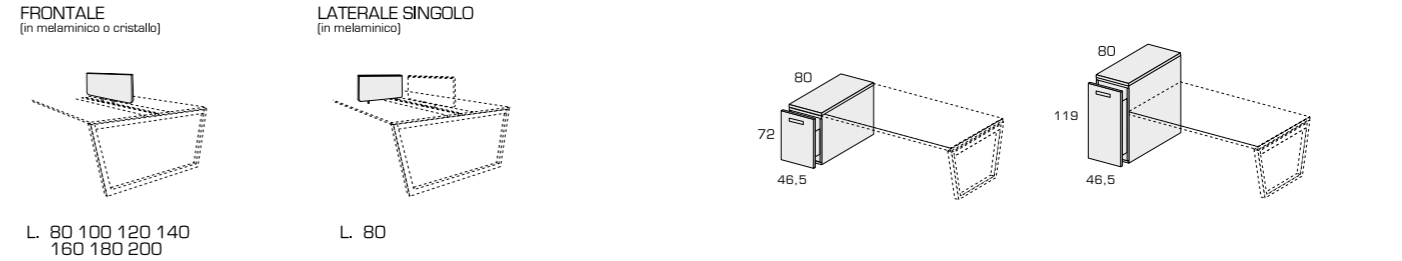

**\_PENISOLA** **\_TAVOLI RIUNIONE**

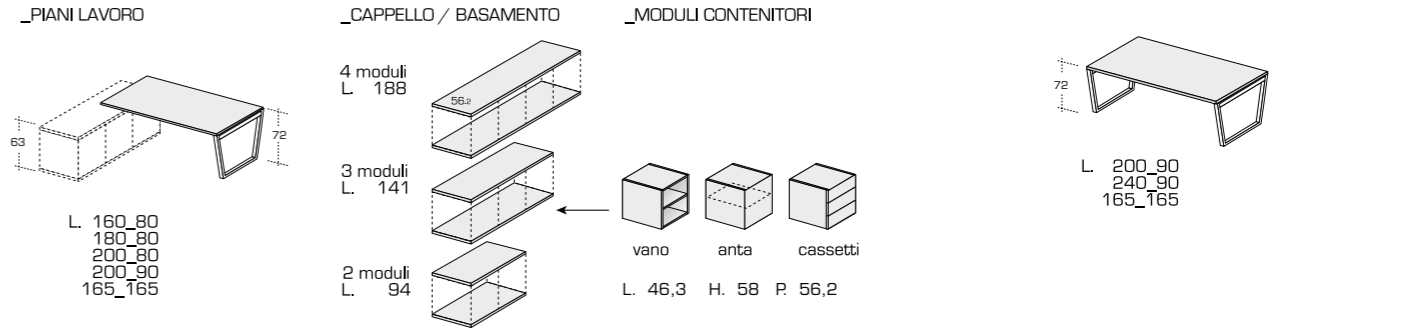

"TALENT WINS THE GAME, BUT TEAMWORK AND INTELLIGENCE WIN THE CHAMPIONSHIP"  
M.JORDAN



SISTEMA INTEGRATO **KS** KOSMOSYSTEM | DESIGN by PERIN&TOPAN

	<b>NEW FINISHES</b>	
	<b>PIANI</b> TOP PLATEAUX	<b>GRAFITE</b> GRAPHITE
		<b>CANAPA</b> WARM GREY_CHANVRE
		<b>VISONE</b> MOSS GREY_VISON
		<b>OTTANIO</b> PETROL GREEN_VERT PÉTROLE
<b>GAMBE</b> LEGS_PIEDS	<b>CANAPA</b> WARM GREY_CHANVRE	
	<b>VISONE</b> MOSS GREY_VISON	





THE RIGHT "SYSTEM" FOR SEAMLESS TEAMWORK



EXCLUSIVE  
**KS**



CARTER PER GAMBA KS\_  
per il passaggio dei cavi lungo la gamba,  
caratterizzato da un'estetica non invasiva.  
In metallo verniciato.

CASING FOR KS LEG\_  
simple housing to run cabling up the leg,  
featuring a discreet aesthetic.  
Coated metal.

CARTER POUR PIÉTEMENT KS\_  
pour le passage des câbles le long  
du piétement, caractérisé par une  
esthétique minimaliste.  
En métal peint.



RE-CREATE AND  
RE-CONFIGURE THE SPACE





KOSMOSYSTEM





**\_SCRIVANIE LINEARI P.80**

\_COMPLETE

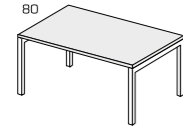

L. 80 100 120 140 160 180 200  
P. 80  
H. 72

\_PER AGGREGAZIONE LINEARE  
INIZIALE

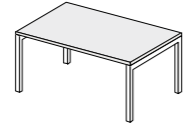

INTERMEDIA

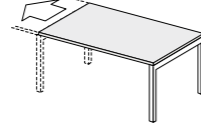

FINALE

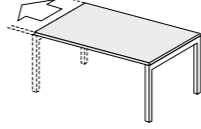

\_PER AGGREGAZIONE A 90°

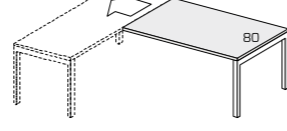

L. 80\_100\_120\_140\_160\_180\_200  
P. 80  
H. 72

**\_SCRIVANIE LINEARI P.60**

\_COMPLETE

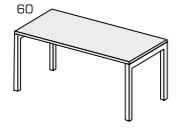

L. 80 100 120 140 160 180 200  
P. 60  
H. 72

\_PER AGGREGAZIONE LINEARE  
INIZIALE

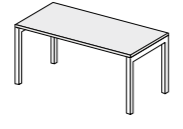

INTERMEDIA

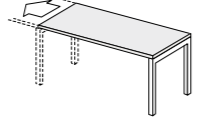

FINALE

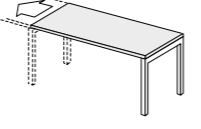

\_PER AGGREGAZIONE A 90°

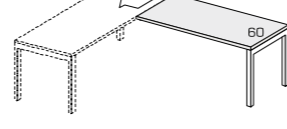

L. 80\_100\_120\_140\_160\_180\_200  
P. 60  
H. 72

**\_SCRIVANIE DOPPIE P.165**

\_COMPLETE

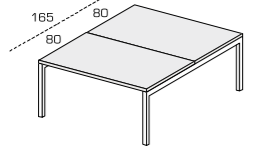

L. 140 160 180 200  
P. 165  
H. 72

\_PER AGGREGAZIONE LINEARE  
INIZIALE

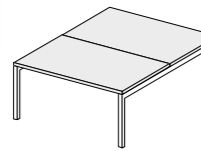

INTERMEDIA

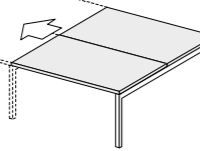

INIZIALE  
CON GAMBA ARRETRATA

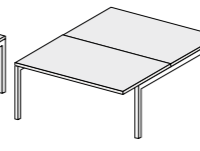

INTERMEDIA  
CON GAMBA ARRETRATA

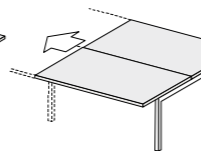

FINALE

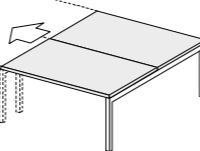

**\_SCRIVANIE LINEARI DOPPIE P.125**

\_COMPLETE

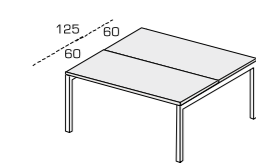

L. 140 160 180 200  
P. 125  
H. 72

\_PER AGGREGAZIONE LINEARE  
INIZIALE

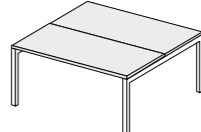

INTERMEDIA

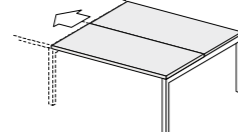

FINALE

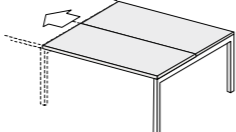

**\_SCREEN**

FRONTALE  
(in melaminico o cristallo)

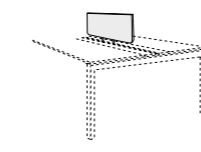

L. 80 100 120 140  
160 180 200

LATERALE SINGOLO  
(in melaminico)

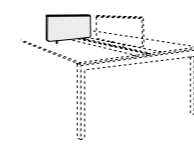

L. 80

**\_ESTRAIBILI - H.72\_H.119**

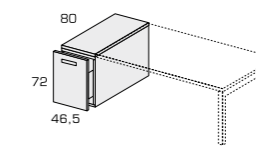

L. 80

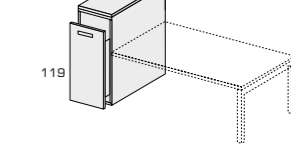

L. 119

**\_PENISOLA**

\_PIANI LAVORO

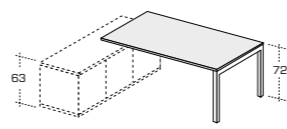

L. 160\_80  
180\_80  
200\_80  
200\_90  
165\_165

\_CAPPELLO / BASAMENTO

4 moduli  
L. 188

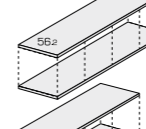

3 moduli  
L. 141

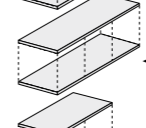

2 moduli  
L. 94

\_MODULI CONTENITORI

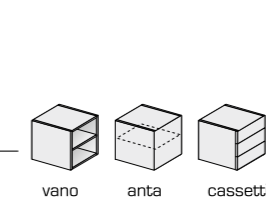

L. 46,3 H. 58 P. 56,2

**\_TAVOLI RIUNIONE H72**

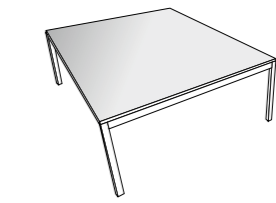

L. 200\_90  
240\_90  
280\_125  
125\_125  
165\_165



"MEN WHO WISH  
TO KNOW ABOUT  
THE WORLD MUST LEARN  
ABOUT IT IN ITS  
PARTICULAR DETAILS"  
HERACLITUS





SISTEMA INTEGRATO **KS•LIGHT** | R&D by IVM



**NEW**

**NEW FINISHES**

<b>PIANI</b> TOP PLATEAUX	<b>GRAFITE</b> GRAPHITE
	<b>CANAPA</b> WARM GREY_CHANVRE
	<b>VISIONE</b> MOSS GREY_VISON
	<b>OTTANIO</b> PETROL GREEN_VERT PÉTROLE
<b>GAMBE</b> LEGS_PIEDS	<b>CANAPA</b> WARM GREY_CHANVRE
	<b>VISIONE</b> MOSS GREY_VISON

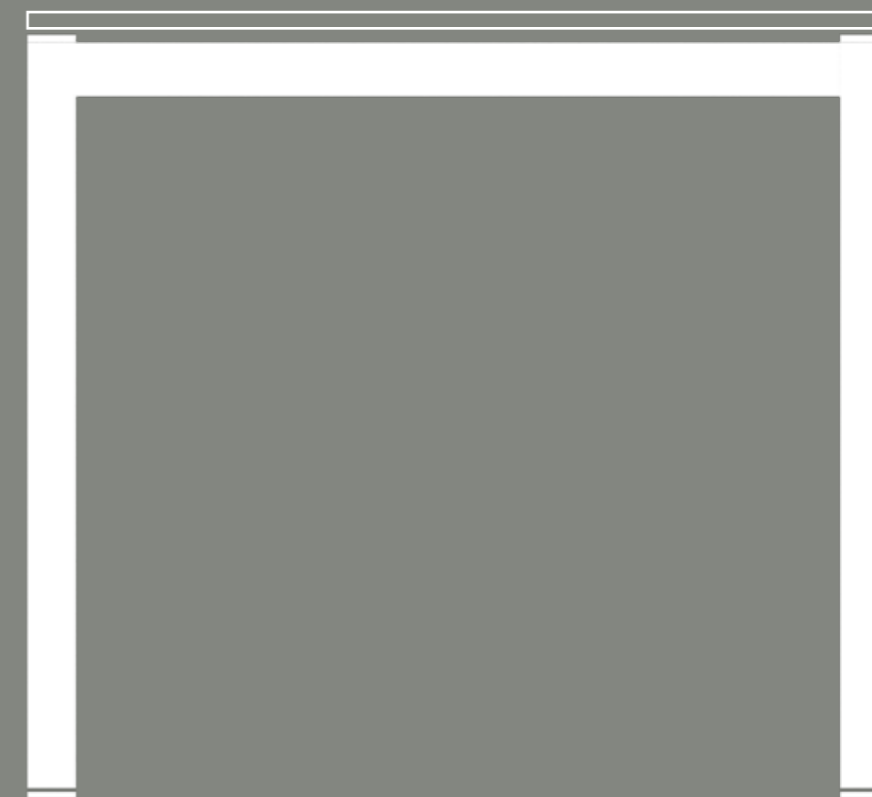

PICK AND CHOOSE  
FOR THE SPACE YOU USE

# BIANCO SPATOLATO CEMENTO FELTRO

DRESSCODEONE

DESIGNING  
AROUND  
THE SPACE  
AND  
AROUND  
THE PERSON





Workstations featuring, anti-conventional solid finishes typical of industrial architecture, integrating all the necessary technological details.



Postazioni operative, caratterizzate da finiture non omologate tipiche dell'architettura industriale, che integrano tutte le dotazioni tecnologiche necessarie.



## WIRE UP

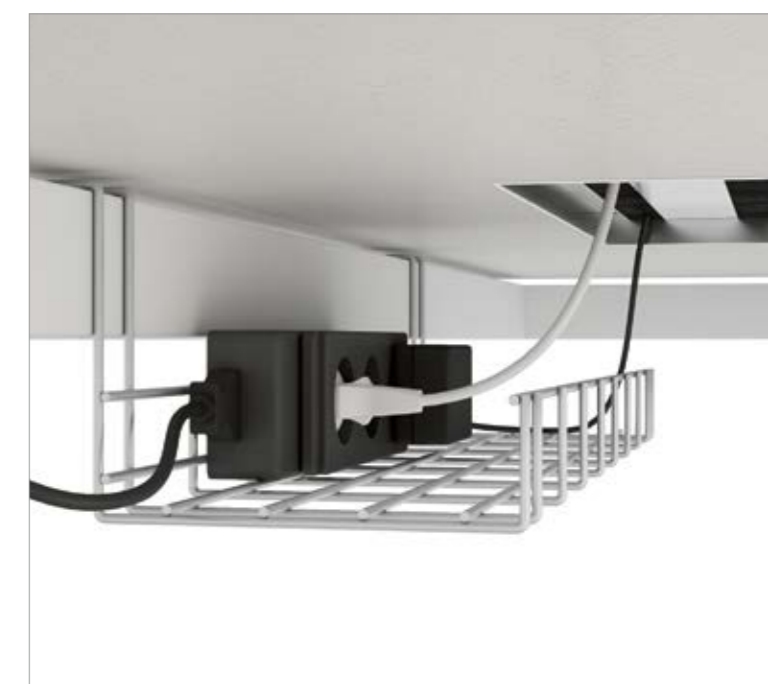

TAKE YOUR BASE, MAKE YOUR SPACE

# VULCANO SPATOLATO CEMENTO FERRO

DRESSCODE TWO

DESIGNING  
AROUND  
THE SPACE  
AND  
AROUND  
THE PERSON



SPATOLATO CEMENTO  
& FERRO



VULCANO  
& FERRO



Mixing and matching colours and materials to create unique work spaces, perfect environments for team working, with sophisticated attention to materials.

Accostamenti cromatici e materici per spazi operativi unici. Ambienti perfetti per l'attività condivisa, con sofisticata attenzione ai materiali.

## DESKS SHARING



PICK AND CHOOSE  
FOR THE SPACE YOU USE

# OLMOTESTAdiMORO SPATOLATO CEMENTO

DRESSCODETHREE

DESIGNING  
AROUND  
THE SPACE  
AND  
AROUND  
THE PERSON

# SPATOLATO CEMENTO & BIANCO





VISONE  
& BIANCO

**PIANI SCRIVANIA**

DESK TOPS  
PLATEAUX de BUREAU

**Nobilitato** spess. 18 mm

**Laminate** thickness 18 mm  
**Melaminé** ép. 18 mm

- VULCANO**
- SPATOLATO CEMENTO** CEMENT RENDER EFFECT / BÉTON TALOCHÉ
- AVORIO** IVORY / IVOIRE
- OLMO PANNA** ELM CREAM / ORME CRÈME
- OLMO TESTA DI MORO** ELM DARK BROWN / ORME FONCÉ
- NOCE** WALNUT / NOYER
- GRAFITE** GRAPHITE
- CANAPA** WARM GREY / CHANVRE
- VISIONE** MOSS GREY / VISON
- OTTANIO** PETROL GREEN / VERT PÉTROLE

**SCREEN** **Nobilitato** spess. 18 mm

**Laminate** thickness 18 mm  
**Melaminé** ép. 18 mm

- FELTRO** FELT / FEUTRE
- SPATOLATO CEMENTO** CEMENT RENDER EFFECT / BÉTON TALOCHÉ
- AVORIO** IVORY / IVOIRE
- OLMO PANNA** ELM CREAM / ORME CRÈME
- OLMO TESTA DI MORO** ELM DARK BROWN / ORME FONCÉ
- NOCE** WALNUT / NOYER
- PENELOPE SABBIA** PENELOPE SAND / PENELOPE SABLE
- PENELOPE ARGILLA** PENELOPE CLAY / PENELOPE ARGILE
- ALLUMINIO** ALUMINIUM
- GRAFITE** GRAPHITE
- CANAPA** WARM GREY / CHANVRE
- VISIONE** MOSS GREY / VISON
- OTTANIO** PETROL GREEN / VERT PÉTROLE

**Cristallo** spess. 8 mm  
**Crystal** thickness 8 mm  
**Verre** ép. 8 mm

**TEMPERATO ACIDATO**  
FROSTED TEMPERED  
TREMPE ACIDE

**Tessuto**

**Fabric**  
**Tissu**

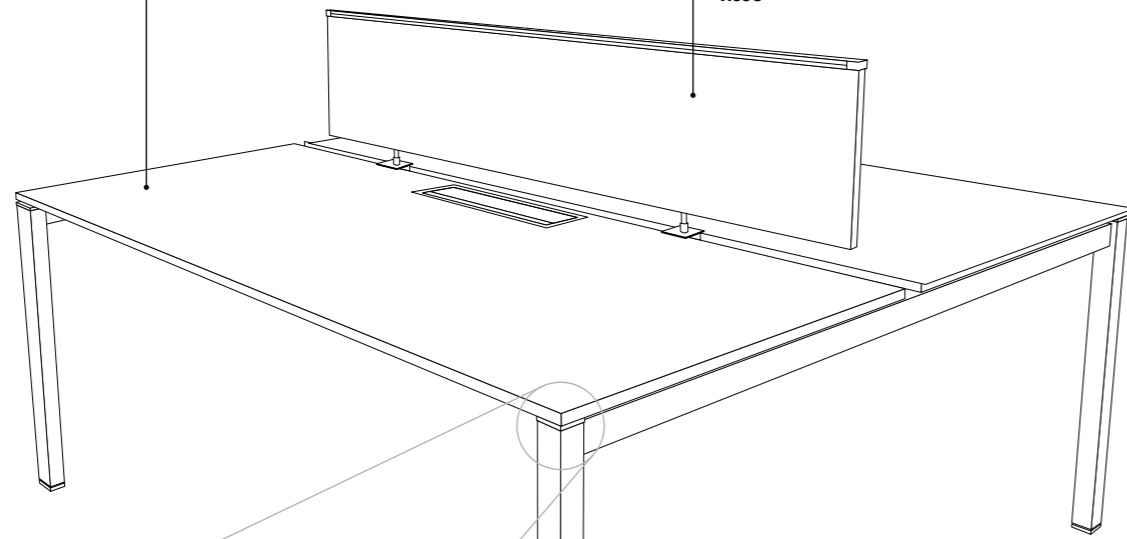

**TAPPO \_CAP/CAPUCHON**  
**CROMO \_CHROME/CROME**  
con GAMBE \_with LEGS/avec PIED  
- BIANCO \_WHITE/BLANC  
- NERO \_BLACK/NOIR  
- ALLUMINIO \_ALUMINIUM  
**BRUNITO \_BURNISHED/BRUNI**  
con GAMBE \_with LEGS/avec PIED  
- \* FERRO \_STEEL/FER

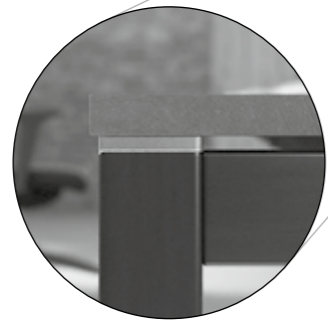

**PIEDINO \_FOOT/PIED**  
**CROMO \_CHROME/CROME**  
con GAMBE \_with LEGS/avec PIED  
- BIANCO \_WHITE/BLANC  
- NERO \_BLACK/NOIR  
- ALLUMINIO \_ALUMINIUM  
**BRUNITO \_BURNISHED/BRUNI**  
con GAMBE \_with LEGS/avec PIED  
- \* FERRO \_STEEL/FER

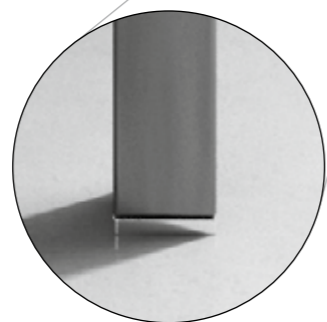

**GAMBE** **Metallo**

**LEGS** **Metal**  
**PIEDS** **Metal**

- BIANCO 9010** WHITE 9010 / BLANC 9010
- NERO** BLACK / NOIR
- ALLUMINIO 9006** ALUMINIUM 9006
- CANAPA** WARM GREY / CHANVRE
- VISIONE** MOSS GREY / VISON
- FERRO \*\*** IRON / FER

\*\* Per FINITURA "FERRO" si intende FERRO GREZZO VERNICIATO TRASPARENTE. EVENTUALI IMPERFEZIONI e/o STRIATURE PIÙ SCURE SONO CARATTERISTICA ESTETICA SPECIFICA DELLA FINITURA "FERRO" STESSA.

\*\* "STEEL" FINISH means CLEAR-COATED RAW STEEL. ANY IMPERFECTIONS and/or DARKER STREAKS ARE TO BE CONSIDERED A NORMAL AESTHETIC FEATURE OF THE "STEEL" FINISH.

\*\* ON APPELLE FINITION « FER » DU FER BRUT RECOUVERT D'UNE PEINTURE TRANSPARENTE. TOUTE IMPERFECTION et/ou RAYURE ÉVENTUELLE PLUS FONCÉE DOIT ÊTRE CONSIDÉRÉE COMME UNE CARACTÉRISTIQUE ESTHÉTIQUE DE CETTE FINITION « FER ».

**\_SCRIVANIE LINEARI P.80**

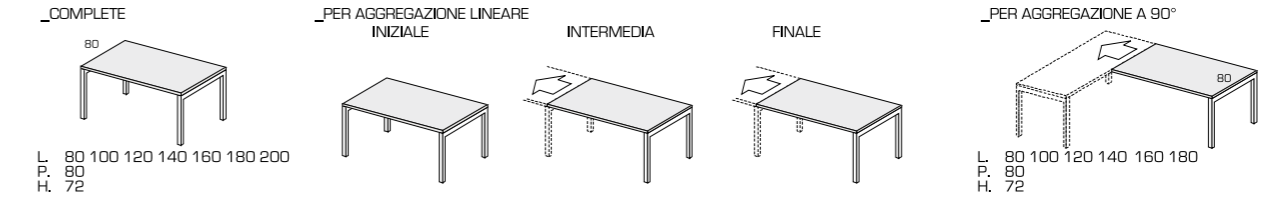

**\_SCRIVANIE LINEARI P.60**

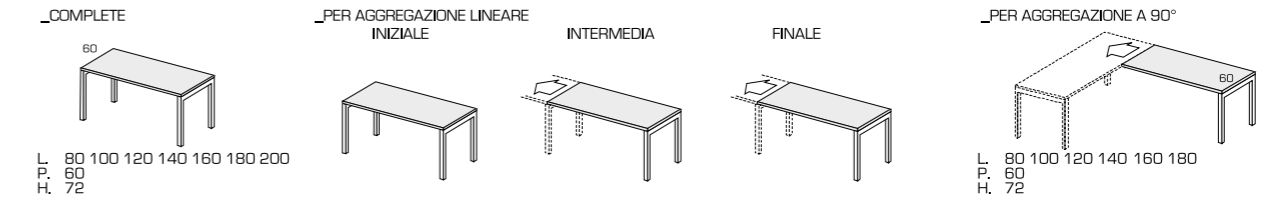

**\_SCRIVANIE DOPPIE P165**

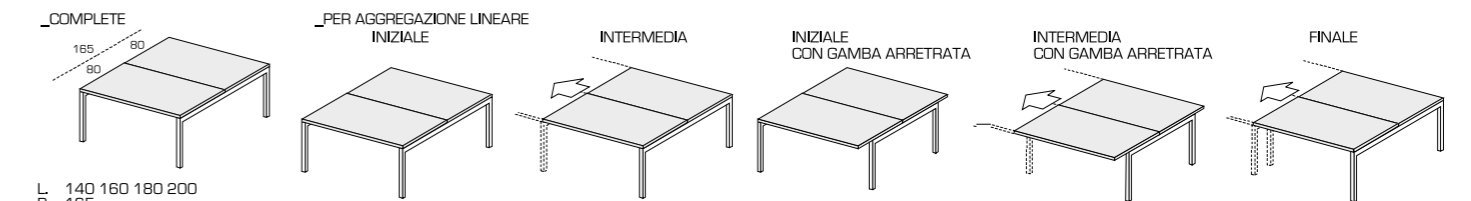

**\_SCRIVANIE LINEARI DOPPIE P.125**

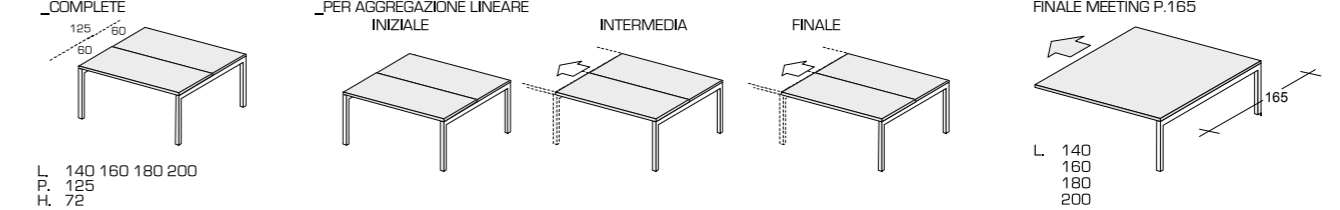

**\_TAVOLI RIUNIONE**

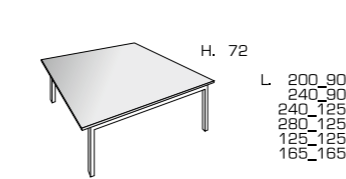

**\_SCREEN**

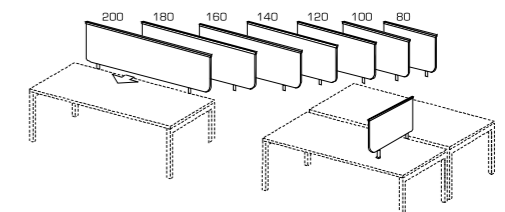

**\_PENISOLA**

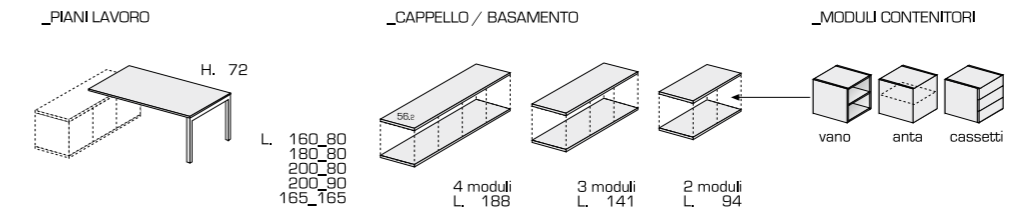

**\_CASSETTIERE**

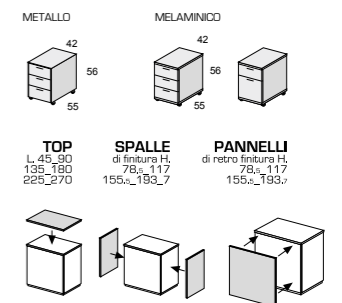

SISTEMI INTEGRATI

# CANALIZZAZIONE & COMPLEMENTI

CABLE MANAGEMENT SYSTEMS  
ACCESSORIES

CANALISATION  
ACCESSOIRES

# CANALIZZAZIONE

CABLE MANAGEMENT SYSTEMS  
CANALISATION



CARTER per gamba arretrata  
CARTER for set-back legs  
PANNEAU CACHE-CÂBLES du pied central



VERTEBRA PASSACAVI  
CABLE MANAGEMENT VERTEBRAE  
VERTÈBRE PASSE CÂBLES



TOP ACCESS\_  
disponibile in diverse dimensioni e finiture,  
garantisce il corretto passaggio dei  
cavi al piano scrivania.

TOP ACCESS\_  
available in a range of sizes and finishes,  
it guarantees that cables run correctly  
to the desktop.

TOP ACCESS\_  
disponible en plusieurs dimensions et finitions,  
garantit le passage adéquat des câbles  
jusqu'au plateau de bureau.



VASSOIO PER ACCUMULO CAVI  
CABLE MANAGEMENT TRAY  
CHEMIN DE CÂBLES

**PORTA CPU SOSPESO**  
adattabile alle diverse dimensioni del cpu stesso.  
Particolarmente efficace nella sua semplicità  
il sistema di "fissaggio" del CPU.

**SUSPENDED CPU HOLDER**  
that can be adapted to the  
actual size of the cpu. The CPU "locking"  
system is as effective as it is simple.

**SUPPORT UC SUSPENDU**  
adaptable aux différentes  
dimensions de l'unité centrale.  
La simplicité du système de fixation  
de l'UC est particulièrement efficace.



**PORTA CPU SOSPESO**  
indicato per elementi di piccole dimensioni.  
Esclusivo il sistema di chiusura con chiave.  
Un dettaglio tecnico unico nel suo genere.

**SUSPENDED CPU HOLDER**  
suitable for small processors.  
Exclusive locking system with key.  
A one-of-a-kind technical detail.

**SUPPORT UC SUSPENDU**  
indiqué pour des éléments  
de petites dimensions.  
Système exclusif de fermeture à clé.  
Une particularité technique unique  
en son genre.

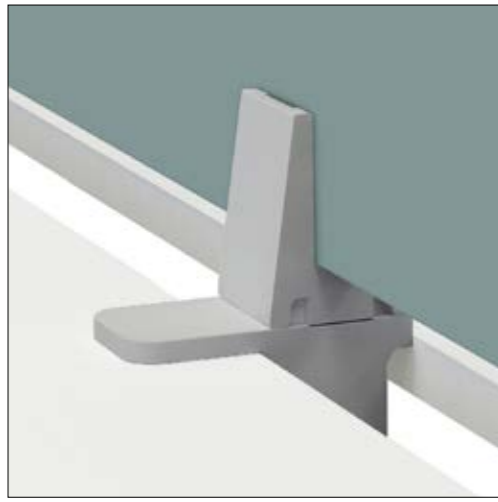

Gli screen sono fissati con appositi supporti metallici posizionabili nello spazio presente tra i due piani.  
L'accesso dei cavi ai piani può essere risolto dal foro+boccola oppure utilizzando lo spazio presente tra i due piani.

Screens are attached by means of special metal mounts positioned in the space between the two tops.  
Cables pass through to the desktop by means of a hole plus cable grommet or the space between the two levels.

Les écrans sont fixés avec des supports métalliques spéciaux à placer dans l'espace présent entre les deux plans.  
L'accès des câbles peut se faire par l'obturateur ou en utilisant l'espace entre les deux plans.

# TIPOLOGIA SCREEN

SCREEN TYPOLOGY  
TYPOLOGIE D'ÉCRAN

SCREEN RIVESTITO IN  
**TESSUTO + FONOASSORBENTE\***  
CON **PROFILO PORTACCESSORI**

SCREEN COVERED IN  
**FABRIC + SOUND-ABSORBENT (PAD)\***  
WITH **ACCESSORIES PROFILE**  
ÉCRAN PRIVATIF AVEC REVÊTEMENT EN  
**TISSU + ACOUSTIQUE\***  
AVEC **PROFIL PORTE-ACCESSOIRES**



SCREEN **TERMOFORMATO\*\***  
**ARCO**  
**THERMOFORMED\*\* SCREEN - ARCHED**  
ÉCRAN EN **THERMOFORMÉ\*\* - ARQUÉE**



SCREEN **TERMOFORMATO\*\***  
**RETTANGOLARE**  
**THERMOFORMED\*\* SCREEN - RECTANGULAR**  
ÉCRAN EN **THERMOFORMÉ\*\* - RECTANGULAIRE**



SCREEN IN **NOBILITATO** (spess. mm 18)  
**BORDATO 4 LATI**  
**SCREEN IN LAMINATE** (18 mm thick)  
**EDGED ON 4 SIDES**  
ÉCRAN PRIVATIF EN **MÉLAMINÉ** (ép. 18 mm)  
**CHANT SUR LES QUATRE CÔTÉS**



SCREEN IN **NOBILITATO** (spess. mm 18)  
CON **PROFILO PORTACCESSORI**  
**SCREEN IN LAMINATE** (18 mm thick)  
WITH **ACCESSORIES PROFILE**  
ÉCRAN PRIVATIF EN **MÉLAMINÉ** (ép. 18 mm)  
AVEC **PROFIL PORTE-ACCESSOIRES**



SCREEN IN **CRISTALLO** (spess. mm 18)  
**ETCHED TEMPERED GLASS SCREEN** (8 mm thick)  
ÉCRAN PRIVATIF EN **VERRE TREMPÉ ACIDÉ** (ép. 8 mm)



**32 colori TESSUTO - STEP MELANGE**  
**32 colors FABRIC**  
**TISSU 32 couleurs**  
**- GO CHECK**  
**- MELANGE**

Vedi **CARTELLA TESSUTI IVM** - Pag. 273  
See **FABRIC FOLDER IVM** - Page 273  
Voir **DOSSIERS EN TISSU IVM** - Page 273

\*Materassino FONOASSORBENTE in Fibra di Poliestere (densità 60 Kg/m<sup>3</sup>) atossico, anallergico, ad ELEVATA EFFICIENZA di ASSORBIMENTO ACUSTICO (CERTIFICATA).

SOUND-ABSORBENT pad in polyester fibre (density of 60 kg/m<sup>3</sup>) non-toxic, non-allergic, HIGH-PERFORMANCE SOUND ABSORPTION (CERTIFIED).

MATÉRIAU ACOUSTIQUE en fibre de polyester (densité de 60 kg/m<sup>3</sup>) non toxique, anallergique, à HAUTE ABSORPTION ACOUSTIQUE (CERTIFIÉE).

**4 colori TESSUTO - MELANGE**  
**4 colors FABRIC**  
**TISSU 4 couleurs**

\*\* In TESSUTO con MATERASSINO FONOASSORBENTE a DENSITÀ VARIABILE ottenuta attraverso la TERMOFORMATURA del materiale con STAMPO in ALLUMINIO.

In FABRIC with MATTRESS SOUND ABSORBENT with VARIABLE DENSITY obtained through the THERMOFORMING of the material with ALUMINIUM MOLD.

En TISSU avec MATELAS ABSORBANT LE SON à DENSITÉ VARIABLE obtenu grâce à la THERMOFORMAGE du matériel avec MOULE EN ALUMINIUM.

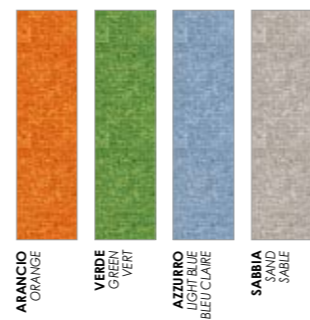

Per una corretta valutazione di tonalità e colore delle diverse finiture rappresentate a catalogo, è necessario fare riferimento ai campioni fisici.

Due to variances in printed colours, see the swatches for the actual colours and shades of the different finishes.

Pour une évaluation correcte du ton et de la couleur des différentes finitions représentées dans le catalogue, il est nécessaire de se référer aux échantillons physiques.



SISTEMI INTEGRATI

FINITURE

FINISHES  
FINITIONS

FINITURE

# le FINITURE dei PIANI

TOP FINISHES  
LES FINITIONS DES PLATEAUX

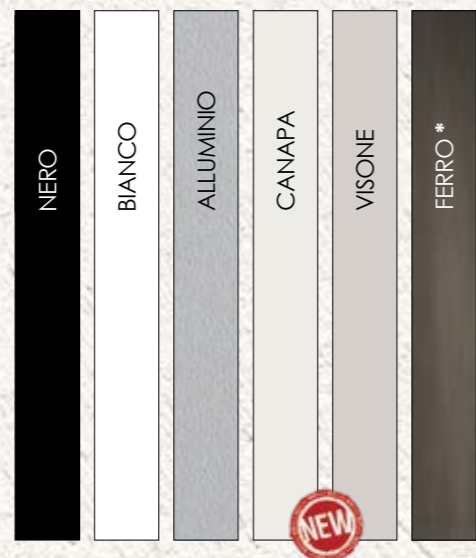

le GAMBE

LEGS  
LE PIÈTEMENT

\* FINITURA "FERRO" SOLO per il modello KS•LIGHT.  
"STEEL" FINISH ONLY for KS•LIGHT model.  
FINITION « FER » SEULEMENT pour KS•LIGHT modèle.

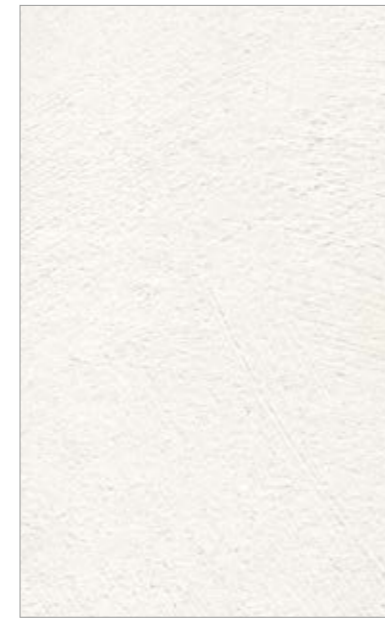

SPATOLATO CEMENTO  
CEMENT RENDER EFFECT / BÉTON TALOCHÉ



AVORIO  
IVORY / IVOIRE

**NOBILITATO**  
LAMINATE  
MELAMINÉ

LE FINITURE DEI PIANI SONO  
LIBERAMENTE ACCOSTABILI  
ALLE FINITURE PREVISTE  
PER LE GAMBE.

MATCH THE TOP FINISH  
WITH THE FINISH  
SELECTED FOR THE LEGS.

LES FINITIONS DES PLATEAUX  
SONT COMBINABLES AVEC LES  
FINITIONS PRÉVUES  
POUR LE PIÈTEMENT.

*Per una corretta valutazione di tonalità  
e colore delle diverse finiture rappresentate  
a catalogo, è necessario fare riferimento  
ai campioni fisici.*

*Due to variances in printed colours,  
see the swatches for the actual colours  
and shades of the different finishes.*

*Pour une évaluation correcte du ton et de  
la couleur des différentes finitions représentées  
dans le catalogue, il est nécessaire  
de se référer aux échantillons physiques.*



GRAFITE  
GRAPHITE

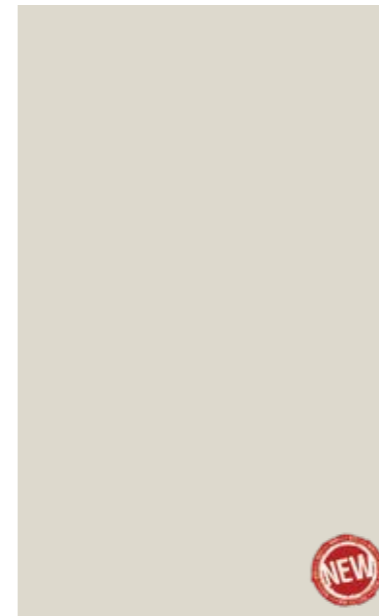

CANAPA  
WARM GREY / CHANVRE



VISIONE  
MOSS GREY / VISON



OTTANIO  
PETROL GREEN / VERT PÉTROLE



VULCANO



OLMO PANNA  
ELM CREAM / ORME CRÈME



OLMO TESTA DI MORO  
ELM DARK BROWN / ORME FONCÉ



NOCE  
WALNUT / NOYER

# le FINITURE degli SCREEN\_ NOBILITATO

LAMINATE SCREEN FINISHES  
LES FINITIONS DES ÉCRANS EN MELAMINÉ



**NOCE**  
WALNUT / NOYER

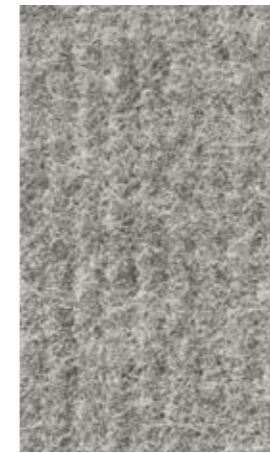

**FELTRO**  
FELT / FEUTRE



**AVORIO**  
IVORY / IVOIRE

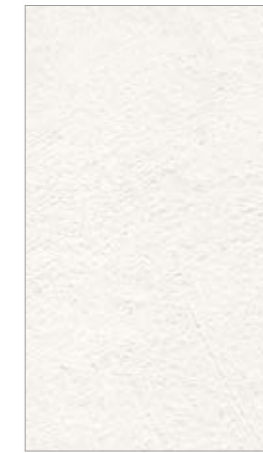

**SPATOLATO CEMENTO**  
CEMENT RENDER EFFECT / BÉTON TALOCHÉ

**NOBILITATO**  
LAMINATE  
MELAMINÉ

LE FINITURE DEGLI SCREEN SONO LIBERAMENTE ACCOSTABILI ALLE FINITURE PREVISTE PER I PIANI.

MATCH THE SCREEN FINISH WITH THE FINISH SELECTED FOR THE TOPS.

LES FINITIONS DES ÉCRANS SONT COMBINABLES AVEC LES FINITIONS PRÉVUES POUR LES PLATEAUX.



**GRAFITE**  
GRAPHITE



**CANAPA**  
WARM GREY / CHANVRE



**VISONI**  
MOSS GREY / VISON



**OTTANIO**  
PETROL GREEN / VERT PÉTROLE



**OLMO PANNA**  
ELM CREAM / ORME CRÈME



**OLMO TESTA DI MORO**  
ELM DARK BROWN / ORME FONCÉ



**PENELOPE SABBIA**  
PENELOPE SAND / SABLE



**PENELOPE ARGILLA**  
PENELOPE CLAY / ARGILE



**ALLUMINIO**  
ALUMINIUM



**CRISTALLO ACIDATO**  
ETCHED GLASS  
VERRE ACIDÉ

Per una corretta valutazione di tonalità e colore delle diverse finiture rappresentate a catalogo, è necessario fare riferimento ai campioni fisici.

Due to variances in printed colours, see the swatches for the actual colours and shades of the different finishes.

Pour une évaluation correcte du ton et de la couleur des différentes finitions représentées dans le catalogue, il est nécessaire de se référer aux échantillons physiques.

le FINITURE degli SCREEN\_ **TESSUTO**  
 FABRIC SCREEN FINISHES  
 LES FINITIONS DES ÉCRANS EN TISSU

**Cat. A MELANGE**

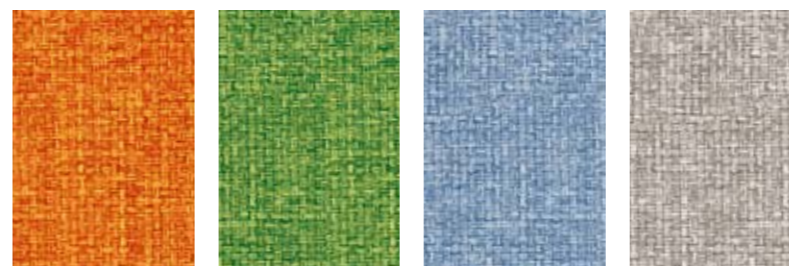

ARANCIO ORANGE    VERDE GREEN / VERT    AZZURRO BLUE / BLEU    SABBIA SAND / SABLE

**Cat. B STEP MELANGE**

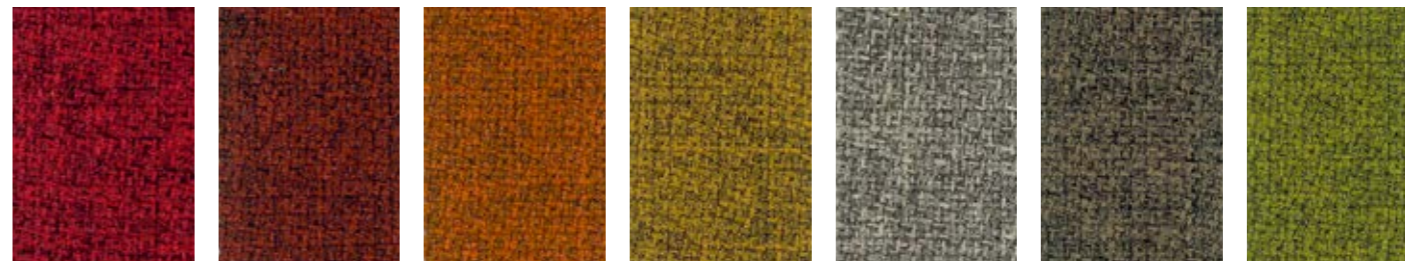

64179    63075    63082    62057    61104    61103    668119



67072    66018    67004    66152    66019    60092    60004

**Cat. C GO CHECK**



64171    61144    63080    61142    61138    61139    68153

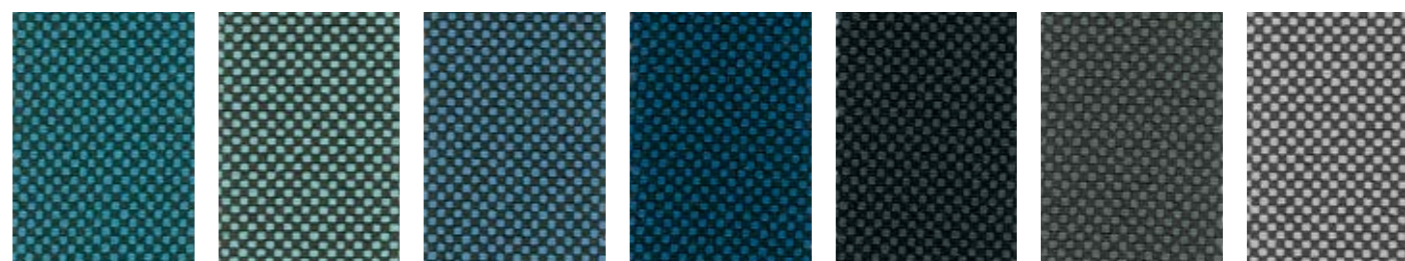

67070    68168    66135    66139    60084    60083    60093

Per una corretta valutazione di tonalità e colore delle diverse finiture rappresentate a catalogo, è necessario fare riferimento ai campioni fisici.

Due to variances in printed colours, see the swatches for the actual colours and shades of the different finishes.

Pour une évaluation correcte du ton et de la couleur des différentes finitions représentées dans le catalogue, il est nécessaire de se référer aux échantillons physiques.

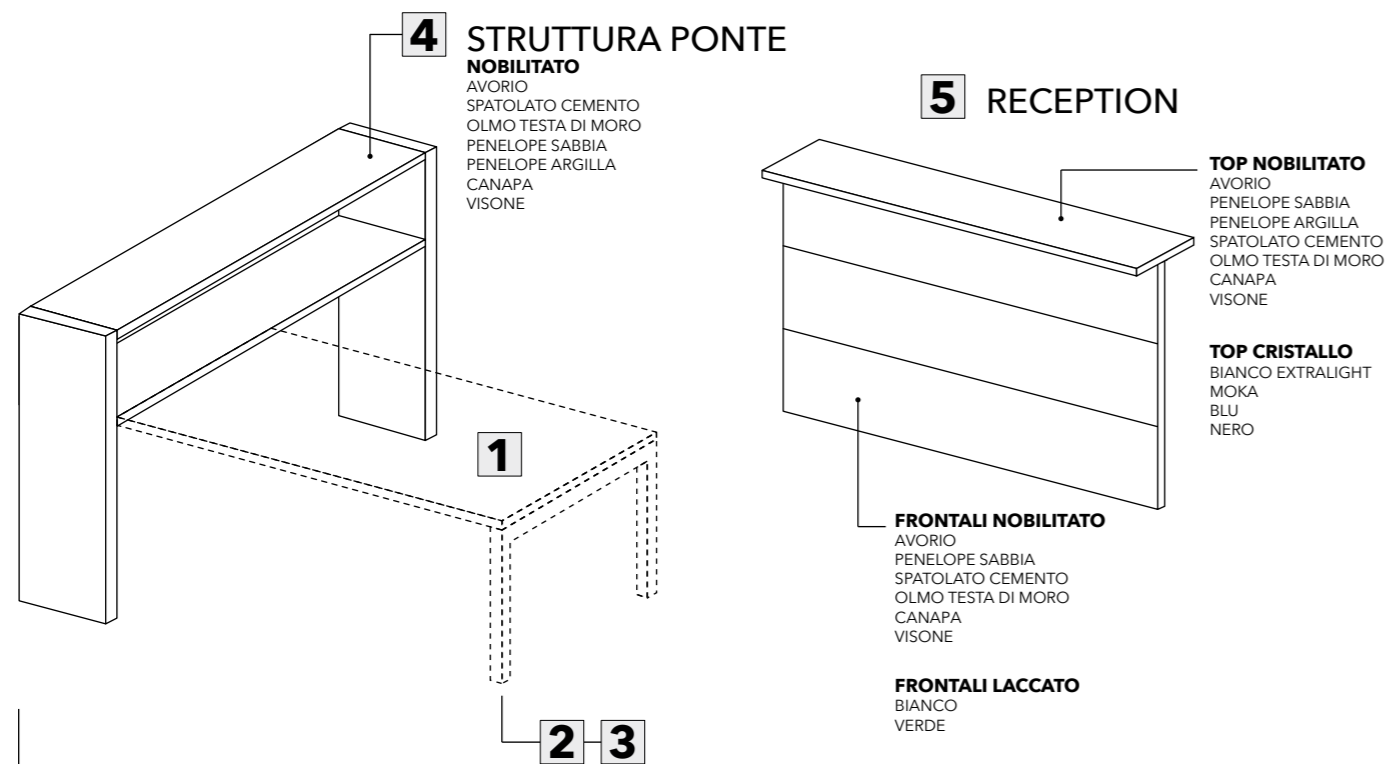
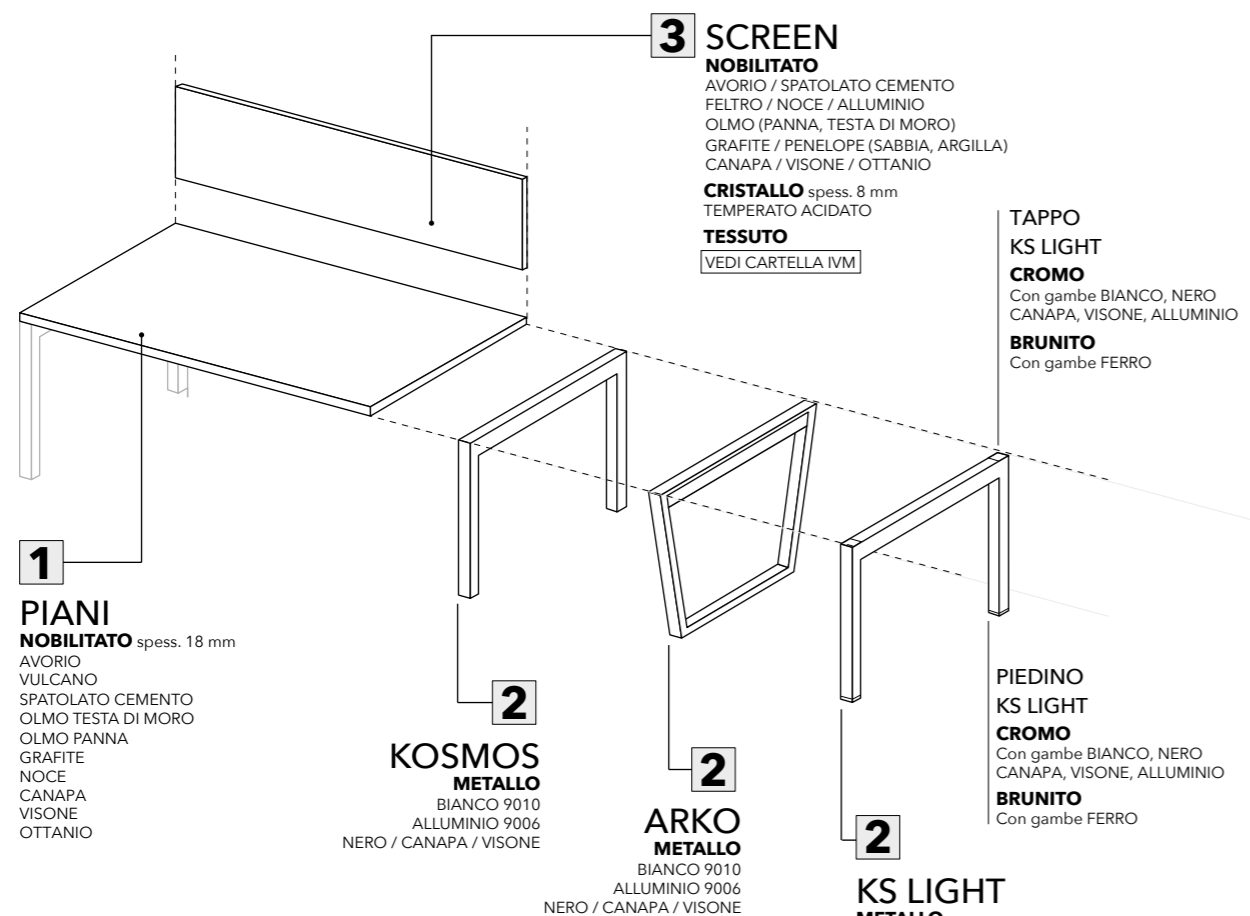

<b>1 PIANI SCRIVANIA</b>	Nobilitato spess. 18 mm	AVORIO VULCANO SPATOLATO CEMENTO OLMO TESTA DI MORO OLMO PANNA	GRAFITE NOCE CANAPA VIGONE OTTANIO
--------------------------	-------------------------	--	--

<b>2 GAMBE IN METALLO</b>	KOSMOS, ARKO, KS LIGHT	BIANCO 9010 ALLUMINIO 9006 NERO	CANAPA VIGONE
---------------------------	------------------------	---------------------------------------	------------------

Finitura solo per KS LIGHT FERRO \*\*

<b>TAPPO e PIEDINO solo per KS LIGHT</b>	CROMO con gambe - BIANCO - ALLUMINIO - NERO - CANAPA - VIGONE BRUNITO con gambe FERRO **
--	---

\*\* SOLO per il modello KS LIGHT.  
Per FINITURA "FERRO" si intende FERRO GREZZO  
VERNICIATO TRASPARENTE. Eventuali IMPERFEZIONI  
e/o STRIATURE piú scure sono CARATTERISTICA  
ESTETICA specifica della FINITURA "FERRO" STESSA.

NOTA GENERALE: Le GAMBE nelle finiture proposte a LISTINO sono liberamente abbinabili alle finiture proposte per i PIANI SCRIVANIA.

<b>3 SCREEN</b>	Nobilitato	AVORIO SPATOLATO CEMENTO FELTRO OLMO TESTA DI MORO OLMO PANNA PENELOPE SABBIA PENELOPE ARGILLA	GRAFITE NOCE ALLUMINIO CANAPA VIGONE OTTANIO
-----------------	------------	--	---

Cristallo spess. 8 mm TEMPERATO ACIDATO

Tessuto VEDI CARTELLA IVM

Tessuto + Fonoassorbente VEDI CARTELLA IVM

<b>4 SISTEMA PONTE</b>	Struttura	AVORIO SPATOLATO CEMENTO OLMO TESTA DI MORO PENELOPE SABBIA	PENELOPE ARGILLA CANAPA VIGONE
------------------------	-----------	--	--------------------------------------

Casellari e Ante ribalta PENELOPE SABBIA  
PENELOPE ARGILLA

Piani Scrivania spess. 18 mm AVORIO  
VULCANO  
SPATOLATO CEMENTO  
OLMO TESTA DI MORO  
GRAFITE NOCE  
CANAPA  
VIGONE  
OTTANIO

Schienale di retrofinitura PENELOPE SABBIA

<b>5 RECEPTION</b>	Frontali Nobilitato	AVORIO PENELOPE SABBIA SPATOLATO CEMENTO	OLMO TESTA DI MORO CANAPA VIGONE
--------------------	---------------------	--	--

Frontali Laccato BIANCO  
VERDE

Top Nobilitato AVORIO  
PENELOPE SABBIA  
PENELOPE ARGILLA  
SPATOLATO CEMENTO OLMO TESTA DI MORO  
CANAPA  
VIGONE

Top Cristallo BIANCO EXTRALIGHT  
MOKA  
BLU  
NERO

Spalle di chiusura AVORIO  
SPATOLATO CEMENTO  
OLMO TESTA DI MORO PENELOPE SABBIA  
CANAPA  
VIGONE

ATTENZIONE Il CODICE individua solo la tipologia dell'elemento.  
Le FINITURE vanno specificate nell'ordine, accanto al codice dell'elemento.

<b>1 DESK TOPS</b>	<b>Laminate</b> thickness 18 mm	IVORY VULCANO CEMENT RENDER EFFECT ELM Dark Brown ELM CREAM	GRAPHITE WALNUT WARM GREY MOSS GREY PETROL GREEN
--------------------	---------------------------------	---	--

<b>2 METAL LEGS</b>	<b>KOSMOS, ARKO</b>	WHITE 9010 ALUMINIUM 9006 BLACK	WARM GREY MOSS GREY
---------------------	---------------------	---------------------------------------	------------------------

**Finish only for KS LIGHT** STEEL \*\*

<b>CAP and FOOT only for KS LIGHT</b>	CHROME	with legs - WHITE - ALUMINIUM - BLACK - WARM GREY - MOSS GREY BURNISHED with legs - STEEL **	<b>** ONLY for KS LIGHT model. STEEL FINISH means CLEAR-COATED RAW STEEL. Any IMPERFECTIONS and/or darker STREAKS are to be considered a NORMAL AESTHETIC FEATURE of the "STEEL" FINISH.</b>
---------------------------------------	--------	---	--

**GENERAL NOTES** LEGS, in the finishes proposed on the price list, can be freely matched to the finishes proposed for **DESK TOPS**.

<b>3 SCREEN</b>	<b>Laminate</b>	IVORY CEMENT RENDER EFFECT FELT ELM DARK BROWN ELM CREAM PENELOPE SAND PENELOPE CLAY	GRAPHITE WALNUT ALUMINIUM WARM GREY MOSS GREY PETROL GREEN
-----------------	-----------------	--	---

**Crystal** thickness 8 mm FROSTED TEMPERED

**Fabric** [SEE SAMPLE FOLDER IVM](#)

**Fabric + Sound Absorbing** [SEE SAMPLE FOLDER IVM](#)

<b>4 BRIDGE SYSTEM</b>	<b>Structure</b>	IVORY CEMENT RENDER EFFECT ELM DARK BROWN PENELOPE SAND	PENELOPE CLAY WARM GREY MOSS GREY
------------------------	------------------	--	---

**Pigeon hole units and Tip-up doors** PENELOPE SAND  
PENELOPE CLAY

<b>Desk tops</b> thickness 18 mm	IVORY VULCANO CEMENT RENDER EFFECT ELM DARK BROWN GRAPHITE	WALNUT WARM GREY MOSS GREY PETROL GREEN
----------------------------------	--	--

**Back panel finish** PENELOPE SAND

<b>5 RECEPTION</b>	<b>Front Panel Laminate</b>	IVORY PENELOPE SAND CEMENT RENDER EFFECT	ELM DARK BROWN WARM GREY MOSS GREY
--------------------	-----------------------------	--	--

**Front Panel Laquered** WHITE  
GREEN

<b>Top Laminate</b>	IVORY PENELOPE SAND PENELOPE CLAY CEMENT RENDER EFFECT	ELM DARK BROWN WARM GREY MOSS GREY
---------------------	---	--

**Top Crystal** EXTRALIGHT WHITE  
MOKA  
BLUE  
BLACK

<b>End Side Panel</b>	IVORY CEMENT RENDER EFFECT ELM DARK BROWN	PENELOPE SAND WARM GREY MOSS GREY
-----------------------	---	---

**NOTE** The **CODE** only indicates the type of element.  
Please specify the **FINISHES** at the time of ordering next to the element code in question.

<b>1 PLATEAUX de BUREAU</b>	<b>Mé laminé</b> ép. 18 mm	IVOIRE VULCANO BÉTON TALOCHÉ ORME FONCÉ ORME CRÈME	GRAPHITE NOYER CHANVRE VISON VERT PÉTROLE
-----------------------------	----------------------------	--	---

<b>2 PIEDS en METAL</b>	<b>KOSMOS, ARKO</b>	BLANC 9010 ALUMINIUM 9006 NOIR	CHANVRE VISON
-------------------------	---------------------	--------------------------------------	------------------

**Finition seulement pour KS LIGHT** FER \*\*

<b>CAPUCHON et PIED seulement pour KS LIGHT</b>	CROME	avec pied - BLANC - ALUMINIUM - NOIR - CHANVRE - VISON BRUNI avec pied - FER **	<b>** SEULEMENT pour KS LIGHT modèle. On appelle FINITION « FER » du FER BRUT RECOUVERT d'une peinture TRANSPARENTE. Toute IMPERFECTION et/ou RAYURE éventuelle plus foncée doit être considérée comme une CARACTÉRISTIQUE ESTHÉTIQUE de cette FINITION « FER ».</b>
---	-------	--	--

**GENERAL NOTES** Les **PIEDS**, dans les finitions proposées dans le catalogue, s'associent librement aux finitions proposées pour les **PLATEAUX DE BUREAU**.

<b>3 SCREEN</b>	<b>Mé laminé</b>	IVOIRE BÉTON TALOCHÉ FEUTRE ORME FONCÉ ORME CRÈME PENELOPE SABLE PENELOPE ARGILE	GRAPHITE NOYER ALUMINIUM CHANVRE VISON VERT PÉTROLE
-----------------	------------------	--	--

**Verre** ép. 8 mm TREMPE ACIDE

**Tissu** [VOIR LE DOSSIER IVM](#)

**Tissu + Insonorisant** [VOIR LE DOSSIER IVM](#)

<b>4 SYSTEME PONT</b>	<b>Structure</b>	IVOIRE BÉTON TALOCHÉ ORME FONCÉ PENELOPE SABLE	PENELOPE ARGILE CHANVRE VISON
-----------------------	------------------	---	-------------------------------------

**Casier et Porte rabattable** PENELOPE SABLE  
PENELOPE ARGILE

<b>Plateaux de bureau</b> ép. 18 mm	IVOIRE VULCANO BÉTON TALOCHÉ ORME FONCÉ GRAPHITE	NOYER CHANVRE VISON VERT PÉTROLE
-------------------------------------	--	---

**Dos de finition** PENELOPE SABLE

<b>5 RÉCEPTION</b>	<b>FAÇADES Mé laminé</b>	IVOIRE PENELOPE SABLE BÉTON TALOCHÉ	ORME FONCÉ CHANVRE VISON
--------------------	--------------------------	---	--------------------------------

**FAÇADES Laqué** BLANC  
VERT

<b>Top Mé laminé</b>	IVOIRE PENELOPE SABLE PENELOPE ARGILE BÉTON TALOCHÉ	ORME FONCÉ CHANVRE VISON
----------------------	--	--------------------------------

**Top Verre** BLANC EXTRALIGHT  
MOKA  
BLEU  
NOIR

<b>Montant final</b>	IVOIRE BÉTON TALOCHÉ ORME FONCÉ	PENELOPE SABLE CHANVRE VISON
----------------------	---------------------------------------	------------------------------------

**ATTENTION** Le **CODE** identifie uniquement la typologie de l'élément.  
Les **FINITIONS** doivent être précisées dans la commande, à côté du code de l'élément.



SISTEMA INTEGRATO  
**LOCKERS & CONTENITORI**  
ELEMENTI



**NEW FINISHES**

**FRONTALI**  
FRONTS  
FAÇADES

**GRAFITE**

GRAPHITE

**CANAPA**

WARM GREY\_CHANVRE

**VISONE**

MOSS GREY\_VISON

**OTTANIO**

PETROL GREEN\_VERT PÉTROLE

NELL'EPOCA DELLA **SHARING ECONOMY**  
L'**AMBIENTE UFFICIO** DEVE PREVEDERE **SOLUZIONI**  
CHE GARANTISCANO CONDIVISIONE  
ANCHE PER GLI ELEMENTI **CONTENITORI**.

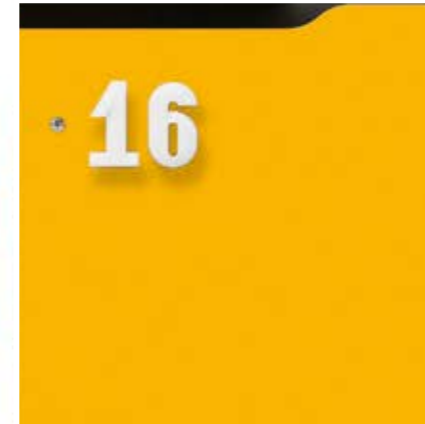

L'ufficio di nuova generazione è un ambiente condiviso, aperto, dove le persone sono al centro di un contesto dinamico. IVM ha progettato il SISTEMA INTEGRATO LOCKERS proprio per questo. Un concetto di CONDIVISIONE dello SPAZIO, modulare e flessibile, che rappresenta la perfetta SOLUZIONE per le esigenze individuali - spesso temporanee - di custodire e contenere all'interno di un'area collettiva.

IVM has designed the LOCKERS SYSTEM for the shared, open environments of new generation offices where people are at the centre of a fast-moving context. This modular and flexible SPACE SHARING concept is the perfect SOLUTION for the often temporary individual needs to safeguard and store personal effects in a communal area.

## SISTEMA INTEGRATO LOCKERS

DESIGN by STUDIO IVM

Le bureau de nouvelle génération est un espace ouvert, partagé, où les personnes sont au cœur d'un contexte dynamique. IVM a conçu le SYSTÈME de CASIERS justement dans ce but. Un concept de PARTAGE de L'ESPACE, modulaire et flexible, qui représente la SOLUTION idéale pour les exigences individuelles, souvent temporaires, de conservation et de maintien au sein d'un espace collectif.



Elementi dinamici e perfettamente integrabili, pensati per offrire infinite combinazioni in termini cromatici e di destinazione d'uso. Quattro concetti base \_lockers, archiviazione, guardaroba, raccolta differenziata\_ che si prestano a innumerevoli possibilità di combinazione a seconda delle specifiche esigenze.

These dynamic, modular units can be perfectly integrated with each other and are designed to provide endless colour combinations and uses. Four basic concepts: lockers, filing, hanging, recycling; that can be mixed and matched to create limitless combinations that meet specific individual needs.

Des éléments dynamiques et parfaitement intégrables, conçus pour offrir des combinaisons de couleurs et d'utilisation à l'infini. Quatre concepts de base : lockers, archivage, penderie, tri sélectif ; qui se prêtent à d'innombrables possibilités de combinaisons en fonction de vos exigences spécifiques.

## SPAZIO CONDIVISIONE SOLUZIONE

...







LOCKERS\_  
La serratura è disponibile  
in due versioni:  
- A COMBINAZIONE  
corpo serratura di colore nero,  
con combinazione a 4 cifre.  
(Vedi foto di dettaglio)  
- STANDARD  
dotata di cilindro estraibile  
con chiave pieghevole  
antifurto ed impugnatura  
coprichiave in ABS.

LOCKERS\_  
Two locks are available:  
- COMBINATION  
with black locking body  
and 4-digit combination.  
(See detail in photo)  
- STANDARD featuring a  
removable barrel and key  
with folding ABS safety key  
cover grip.

LOCKERS\_  
La serrure est disponible en  
deux versions :  
- À COMBINAISON  
avec corps de serrure noir  
et combinaison à 4 chiffres.  
(Voir les détails sur les photos)  
- STANDARD  
munie d'un cylindre amovible  
avec couvre-clé de  
protection pliant en ABS.



## SPAZIO CONDIVISIONE SOLUZIONE

...

## LA PROFONDITÀ DELLA LUCE

Nuove atmosfere per gli spazi condivisi.  
Suggerimenti luminosi per dare vita a  
progetti personalizzati, che accendono l'anima  
dell'ufficio, per uno spazio di movimento e relazione.

New vibes for shared spaces.  
Bright impressions to create customised projects  
that light up the heart and soul of the office  
for an engaging, mobile space.

De nouvelles atmosphères pour les espaces partagés.  
Des suggestions lumineuses pour donner naissance  
à des projets personnalisés, qui éveillent  
l'âme du bureau, pour un espace qui encourage  
les déplacements et les relations.



01

## SPAZIO CONDIVISIONE SOLUZIONE

...

## IL COLORE

Combinazioni cromatiche in totale libertà progettuale. La creatività trova la sua massima espressione grazie alla libertà di interpretare e scegliere un colore o una diversa finitura per ogni singola anta locker.

Full design freedom to mix and match colours. Creativity at its finest due to the freedom to interpret and choose a colour or a different finish for each locker door.

Des combinaisons de couleur pour une liberté conceptuelle totale. La créativité trouve son expression maximale grâce à la liberté d'interpréter et de choisir une couleur ou une finition différente pour chacune des portes du casier.

05

09







SPACE  
SHARING  
SOLUTION  
...



COLOUR

I Lockers, grazie alla presenza di una fessura per inserire corrispondenza, riviste e plichi, possono essere utilizzati anche in assenza dell'utente e assicurano comunque un alto livello di protezione dei documenti anche in caso di spazi condivisi e orari flessibili.

The slots in the Lockers can be used to insert correspondence, magazines and pouches when the user is absent, ensuring a high degree of protection for the documents, despite the shared workplaces and flexible hours.

Grâce à la présence d'une fente permettant de glisser du courrier, des revues et des colis, les Lockers peuvent être utilisés même en l'absence de l'utilisateur ; ils garantissent un haut degré de protection des documents, y compris dans le cadre d'espaces partagés et d'horaires flexibles.





SPAZIO  
CONDIVISIONE  
SOLUZIONE



...  
**AREA BREAK**

Concedersi una pausa in ufficio è tutta un'altra cosa se avviene in uno spazio organizzato e pensato per rispondere alle esigenze individuali in un contesto di relazione. Ancor più pensando alle diverse dinamiche temporali. L'area break è uno dei luoghi dove si esprime perfettamente il concetto del sistema integrato LOCKERS.

Taking a break at work is something else entirely when there is an organised space designed to respond to individual needs in a context of interaction. Even more so when you think of the different dynamics of time. The breakout area is one of those places where the concept of the LOCKERS system is clearly conveyed.

S'offrir une pause au bureau prend une toute autre dimension si elle a lieu dans un espace organisé et pensé pour répondre aux exigences individuelles dans un cadre relationnel. Ce qui prend tout son sens si l'on pense aux différentes dynamiques temporelles. L'espace pause est l'un des lieux dans lesquels le concept du système de CASIERS s'exprime parfaitement.







AREA TECNICA  
TECHNICAL AREA  
SECTION TECHNIQUE

...

SISTEMA INTEGRATO  
**LOCKERS**

DESIGN by STUDIO IVM

- 322\_323 **TIPOLOGIA**
- 324 **FINITURE**
- 324\_325 **SPECIFICHE TECNICHE**
- 326\_327 **ABACO DEGLI ELEMENTI**

SISTEMA INTEGRATO  
**LOCKERS**

Modulare e componibile, il **sistema integrato LOCKERS** di IVM, presenta elementi con diverse destinazioni d'uso: lockers, archiviazione, guardaroba, raccolta differenziata.

**Le quattro destinazioni d'uso sono perfettamente integrabili tra loro.**

In addition to the lockers, the modular IVM **LOCKERS system** features elements with a different purpose: lockers, storage, hanging, recycling.

**The four types of use can be perfectly integrated with each other.**

Modulaire, le **système de LOCKERS** d'IVM propose des rangements aux destinations multiples : lockers, archivage, penderie, tri sélectif.

**Les quatre utilisations prévues sont parfaitement intégrables entre elles.**



## SISTEMA INTEGRATO LOCKERS

### LE FINITURE

#### FRONTALI NOBILITATO - spess. 18 mm

LAMINATED FRONTS - DOORS, DRAWERS, FILING UNITS (18 mm THICK)  
FAÇADES EN MÉLAMINÉ - PORTES, TIROIRS, CLASSEURS - 18 mm ÉPAIS

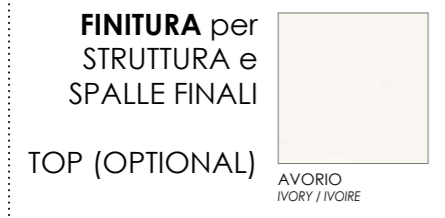
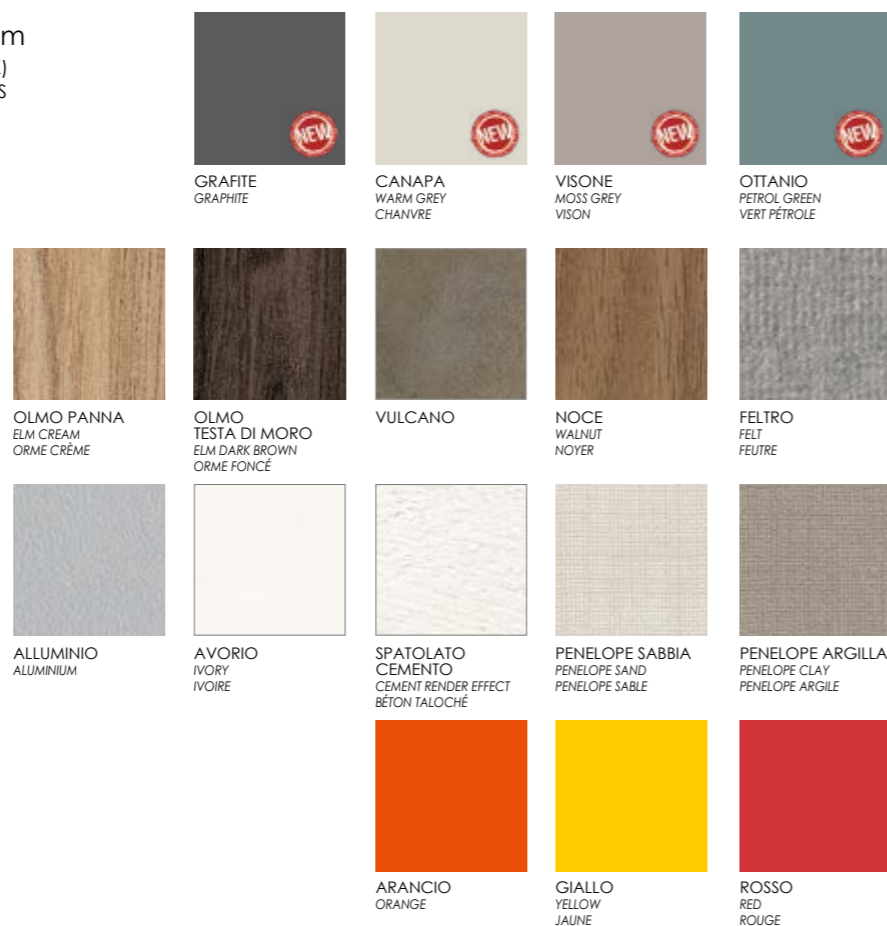

### SPECIFICHE TECNICHE

Modulare e componibile, il sistema LOCKERS di IVM presenta elementi con diverse destinazioni d'uso: LOCKERS, ARCHIVIAZIONE, GUARDAROBA, RACCOLTA DIFFERENZIATA. Le quattro destinazioni d'uso sono perfettamente integrabili tra loro.

#### STRUTTURA

Realizzata in conglomerato ligneo sp. 18 mm (schienali sp. 7 mm), con densità di circa 650 Kg/m<sup>3</sup>, nobilitata su entrambi i lati mediante l'utilizzo di carte melaminiche a grammatura 120 gr/mq e con finitura superficiale antigraffio ed antiriflesso, nella finitura Avorio. I bordi perimetrali sono costituiti da una miscela in ABS, incollati con colla poliuretanicca ed arrotondati. Base dotata di piedini fissi con livellatore colore nero.

#### ANTE

Realizzate in conglomerato ligneo sp. 18 mm con densità di circa 650 Kg/m<sup>3</sup>, nobilitate su entrambi i lati mediante l'utilizzo di carte melaminiche a grammatura 120 gr/mq e con finitura superficiale antigraffio ed antiriflesso, nelle finiture NOBILITATO Avorio, Alluminio, Spatolato Cemento, Olmo Testa di Moro, Olmo Panna, Noce, Penelope Sabbia, Penelope Argilla, Vulcano, Feltro, Rosso, Giallo, Arancio, Grafite, Canapa, Visone e Ottanio. Tutte le ante sono dotate di cerniere in acciaio regolabili con chiusura Soft ed apertura 110°.

#### TOP (opzionali)

Realizzati in conglomerato ligneo sp. 18 mm, con densità di circa 650 Kg/m<sup>3</sup>, nobilitati su entrambi i lati mediante l'utilizzo di carte melaminiche a grammatura 120 gr/mq e con finitura superficiale antigraffio ed antiriflesso, nella finitura Avorio. I bordi perimetrali sono costituiti da una miscela in ABS, incollati con colla poliuretanicca ed arrotondati.

nel dettaglio

#### LOCKERS

Possibilità di avere le ante predisposte per l'applicazione di uno, due o tre numeri ordinabili separatamente (numerazione possibile da 0 fino a 999) in ABS in colore Bianco con funzione sia di identificazione vano che di maniglia di apertura. L'anta dei LOCKERS è inoltre caratterizzata da una particolare "sagomatura" utile per inserire agevolmente corrispondenza, riviste e plichi. Tutte le ante sono complete di serratura, disponibile in due versioni:  
- A COMBINAZIONE: corpo serratura di colore nero, con combinazione a 4 cifre.  
- STANDARD: dotata di cilindro estraibile con chiave pieghevole antinfortunio ed impugnatura coprichiave in ABS.

#### ARCHIVIAZIONE

Disponibile nelle due altezze di sistema, cm 144,5 (comprensivo di 2 ripiani interni) e cm 193,7 (comprensiva di 3 ripiani interni) e in due larghezze (45/90). Ante disponibili con serratura nella versione STANDARD, dotata di cilindro estraibile con chiave pieghevole antinfortunio ed impugnatura coprichiave in ABS.

#### GUARDAROBA

Disponibile nelle due altezze di sistema 144,5 e 193,7 (comprensivo di 1 ripiano interno) e nelle due larghezze di sistema (cm 45/90). Appendiabiti disponibili in due varianti: tubo o estraibile. Ante disponibili con serratura nella versione STANDARD, dotata di cilindro estraibile con chiave pieghevole antinfortunio ed impugnatura coprichiave in ABS.

#### RACCOLTA DIFFERENZIATA

Disponibile in altezza cm 144,5 (comprensivo di 1 ripiano interno) e nelle due larghezze di sistema (cm 45/90). Ogni anta è dotata di "sportellino" basculante con angoli arrotondati, caratterizzato sul frontale dall'icona riciclo.

### TECHNICAL SPECIFICATIONS

The modular IVM LOCKERS system features elements with a different purpose: LOCKERS, STORAGE, HANGING, RECYCLING. The four different types can be perfectly integrated with each other.

#### STRUCTURE

Made from 18 mm thick particleboard (Backs 7 mm thick), with a density of about 650 kg/m<sup>3</sup>, covered on both sides by a layer of melamine-coated paper (120 g/m<sup>2</sup>), with a scratch-proof and anti-reflective surface, in Ivory finish. The edges are made from an ABS compound, fixed with polyurethane glue and rounded. Base fitted with fixed, black adjustable levellers.

#### DOORS

Made from 18 mm thick particleboard (Backs 7 mm thick), with a density of about 650 kg/m<sup>3</sup>, covered on both sides by a layer of melamine-coated paper (120 g/m<sup>2</sup>), with a scratch-proof and anti-reflective surface, in the following finishes: Ivory, Aluminium, Cement Render Effect, Dark Brown Elm, Cream Elm, Walnut, Penelope Sand, Penelope Clay, Vulcano, Felt, Red, Yellow, Orange, Graphite, Warm Grey, Moss Grey and Petrol Green LAMINATE. All doors are fitted with adjustable steel hinges with Soft-closing mechanism and an opening of 110°.

#### TOPS (optional)

Made from 18 mm thick particleboard, with a density of about 650 kg/m<sup>3</sup>, covered on both sides by a layer of melamine-coated paper (120 g/m<sup>2</sup>), with a scratch-proof and anti-reflective surface, in Ivory finish. The edges are made from an ABS compound, fixed with polyurethane glue and rounded.

more details

#### LOCKERS

It is possible for the doors to have provision for the application of one, two or three numbers (from 0 to 999), to be ordered separately. These are made from White ABS and have the dual function of locker identification and door handle. The doors of the LOCKERS are also specially contoured, creating a useful slot to easily insert correspondence, magazines and pouches. All doors come with locks, available in two variants:  
- COMBINATION: black locking body and 4-digit combination.  
- STANDARD: featuring a removable barrel and key with folding ABS safety key cover grip.

#### STORAGE

Available in the two system heights of 144.5 cm (with 2 inner shelves) and 193.7 cm (with 3 inner shelves) and in two widths (45 and 90 cm). Door available with STANDARD lock, featuring a removable barrel and key with folding ABS safety key cover grip.

#### WARDROBE

Available in the two system heights of 144.5 cm and 193.7 cm (with 2 inner shelves) and the two system widths of 45 and 90 cm. Rails available in two variants: tube or pull-out. Door available with STANDARD lock, featuring a removable barrel and key with folding ABS safety key cover grip.

#### RECYCLING

Available in the height of 144.5 cm (with 1 inner shelf) and the two system widths of 45 and 90 cm. Each door has a double-swing flap with rounded corners, featuring the recycling icon on the front.

### SPÉCIFICATIONS TECHNIQUES

Modulaire, le système de LOCKERS d'IVM propose des rangements aux destinations multiples : LOCKERS, ARCHIVAGE, PENDERIE, TRI SÉLECTIF. Les quatre utilisations prévues sont parfaitement intégrables entre elles.

#### STRUCTURE

Réalisée en aggloméré de bois de 18 mm d'épaisseur (dos de 7 mm d'épaisseur), avec une densité d'environ 650 kg/m<sup>3</sup> ; revêtement en mélaminé sur les deux côtés (grammage papier : 120 g/m<sup>2</sup>) ; traitement anti-rayures et antireflet. Finition disponible : Ivoire. Les chants sur le pourtour sont en ABS, collés avec de la colle polyuréthane et arrondis. Socle avec pieds fixes pour réglage de niveau de couleur noir.

#### PORTES

Réalisées en aggloméré de bois de 18 mm d'épaisseur, avec une densité d'environ 650 kg/m<sup>3</sup> ; revêtement en mélaminé sur les deux côtés (grammage papier : 120 g/m<sup>2</sup>) ; traitement anti-rayures et antireflet. Finitions disponibles : MÉLAMINÉ Ivoire, Aluminium, Béton taloché, Orme foncé, Orme crème, Noyer, Penelope sable, Penelope Argile, Vulcano, Feutre, Canapa, Visone, Ottanio, Rouge, Jaune, Orange, Graphite, Chanvre, Vison et Vert Pétrôle. Toutes les portes sont équipées de charnières en acier réglables avec fermeture amortie Soft close et ouverture à 110°.

#### TOP (en option)

Réalisés en aggloméré de bois de 18 mm d'épaisseur, avec une densité d'environ 650 kg/m<sup>3</sup> ; revêtement en mélaminé sur les deux côtés (grammage papier : 120 g/m<sup>2</sup>) ; traitement anti-rayures et antireflet. Finition disponible : Ivoire. Les chants sur le pourtour sont en ABS, collés avec de la colle polyuréthane et arrondis.

en détail

#### LOCKERS

Possibilité de préparer les portes de façon à appliquer un, deux ou trois numéros à commander séparément (numérotation de 0 à 999) en ABS blanc faisant office à la fois d'identification du casier et de poignée d'ouverture. La porte des casiers se démarque également par sa « forme » spéciale qui comporte une fente permettant de glisser aisément du courrier, des revues et des colis. Toutes les portes sont munies de serrure, disponible en deux versions :  
- À COMBINAISON : corps de serrure noir et combinaison à 4 chiffres.  
- STANDARD : munie d'un cylindre amovible avec couvre-clé de protection pliant en ABS.

#### ARCHIVAGE

Disponibles dans les deux hauteurs prévues pour le système : 144,5 cm (avec 2 étagères intérieures) et 193,7 cm (avec 3 étagères intérieures) et en deux largeurs (45/90). Portes disponibles avec serrure en version STANDARD, munies d'un cylindre amovible avec couvre-clé de protection pliant en ABS.

#### PENDERIE

Disponibles dans les deux hauteurs prévues pour le système : 144,5 et 193,7 cm (avec 1 étagère intérieure) et les deux largeurs prévues pour le système (45/90 cm). Penderies disponibles en deux variantes : tubulaire ou amovible. Portes disponibles avec serrure en version STANDARD, munies d'un cylindre amovible avec couvre-clé de protection pliant en ABS.

#### TRI SÉLECTIF

Disponibles dans une hauteur de 144,5 cm (avec 1 étagère intérieure) et les deux largeurs prévues pour le système (45/90 cm). Chaque porte est munie d'un « guichet » à bascule aux angles arrondis, caractérisée, sur la face avant, par le symbole de recyclage.

# H144,5 prof. 44,5

	VANI INIZIALI	VANI INTERMEDI					
<b>LOCKERS</b> 3 MODULI	1,8 mm spalla + L.45	1,8 mm spalla + L.45	1,8 mm spalla + L.45	1,8 mm spalla + L.45	1,8 mm spalla + L.90	1,8 mm spalla + L.90	
<b>CONTENITORE</b> 2 RIPIANI <b>STORAGE</b>		2 RIPIANI   LOCKERS	2 RIPIANI   1 RIPIANO	2 RIPIANI   2 RIPIANI	2 RIPIANI   1 RIPIANO	2 RIPIANI   2 RIPIANI	
<b>CONTENITORE</b> 1 RIPIANO <b>WARDROBE</b> RECYCLING		1 RIPIANO   LOCKERS	1 RIPIANO   1 RIPIANO	1 RIPIANO   2 RIPIANI	1 RIPIANO   1 RIPIANO	1 RIPIANO   2 RIPIANI	
<b>CONTENITORE</b> 2 RIPIANI <b>STORAGE</b>	1,8 mm spalla + L.90	2 RIPIANI   LOCKERS	2 RIPIANI   1 RIPIANO	2 RIPIANI   2 RIPIANI	2 RIPIANI   1 RIPIANO	2 RIPIANI   2 RIPIANI	
<b>CONTENITORE</b> 1 RIPIANO <b>WARDROBE</b> RECYCLING		1 RIPIANO   LOCKERS	1 RIPIANO   1 RIPIANO	1 RIPIANO   2 RIPIANI	1 RIPIANO   1 RIPIANO	1 RIPIANO   2 RIPIANI	

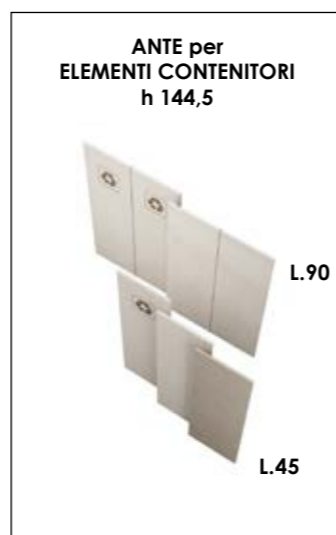
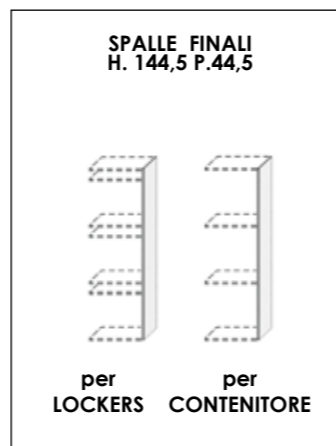

**OPTIONAL**  
TOP DI FINITURA spess. 18 mm.  
Ogni composizione del sistema LOCKERS può essere rifinita con TOP di finitura spess. 18 mm.

# H193,7 prof. 44,5

	VANI INIZIALI	VANI INTERMEDI					
<b>LOCKERS</b> 4 MODULI	1,8 mm spalla + L.45	1,8 mm spalla + L.45	1,8 mm spalla + L.45	1,8 mm spalla + L.45	1,8 mm spalla + L.90	1,8 mm spalla + L.90	
<b>CONTENITORE</b> 3 RIPIANI <b>STORAGE</b>		3 RIPIANI   LOCKERS	3 RIPIANI   1 RIPIANO	3 RIPIANI   3 RIPIANI	3 RIPIANI   1 RIPIANO	3 RIPIANI   3 RIPIANI	
<b>CONTENITORE</b> 1 RIPIANO <b>WARDROBE</b>		1 RIPIANO   LOCKERS	1 RIPIANO   1 RIPIANO	1 RIPIANO   3 RIPIANI	1 RIPIANO   1 RIPIANO	1 RIPIANO   3 RIPIANI	
<b>CONTENITORE</b> 3 RIPIANI <b>STORAGE</b>	1,8 mm spalla + L.90	3 RIPIANI   LOCKERS	3 RIPIANI   1 RIPIANO	3 RIPIANI   3 RIPIANI	3 RIPIANI   1 RIPIANO	3 RIPIANI   3 RIPIANI	
<b>CONTENITORE</b> 1 RIPIANO <b>WARDROBE</b>		1 RIPIANO   LOCKERS	1 RIPIANO   1 RIPIANO	1 RIPIANO   3 RIPIANI	1 RIPIANO   1 RIPIANO	1 RIPIANO   3 RIPIANI	

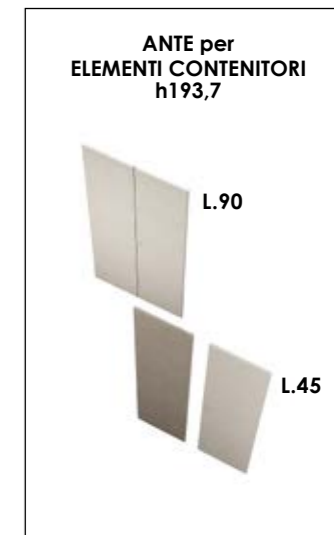
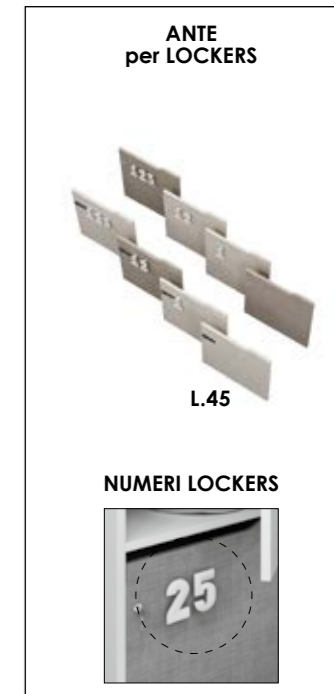
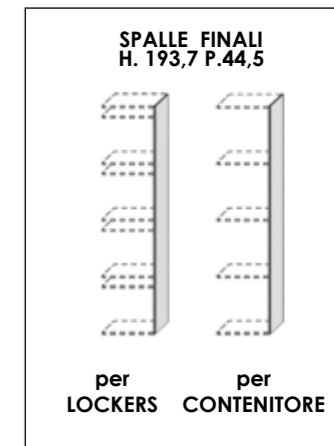

**OPTIONAL**  
TOP DI FINITURA spess. 18 mm.  
Ogni composizione del sistema LOCKERS può essere rifinita con TOP di finitura spess. 18 mm.



SPAZIO  
ARCHIVIAZIONE  
SOLUZIONE

...

GLI ELEMENTI  
**CONTENITORI**



SPACE  
FILING  
SOLUTION

...

STORAGE  
UNITS



## SPAZIO ARCHIVIAZIONE SOLUZIONE

...

## MODULARITÀ

Modularità, flessibilità.  
Infinite combinazioni per l'ARCHIVIAZIONE.  
SOLUZIONI che consentono di organizzare  
perfettamente ogni SPAZIO offrendo allo  
stesso tempo privacy, riservatezza,  
sicurezza ma anche accessibilità,  
praticità, ordine.

Modularity, flexibility.  
Endless combinations for FILING.  
SOLUTIONS that make it possible  
to organise every SPACE to perfection,  
providing privacy, confidentiality and  
security, and accessibility, convenience  
and neatness at the same time.

Modularité, flexibilité.  
Des combinaisons d'ARCHIVAGE à l'infini.  
Des SOLUTIONS qui permettent d'organiser  
chaque ESPACE à la perfection tout en  
s'attachant à garantir la confidentialité,  
la sécurité mais aussi l'accessibilité,  
la fonctionnalité et l'ordre.

**SISTEMA SLOW MOTION**

Tutte le ante dei contenitori sono dotate di cerniere con sistema ammortizzatore SLOW-MOTION. Questo sistema assicura un funzionamento perfetto, silenzioso e controllato anche in condizioni di chiusura "violenta" dell'anta. Apertura anta a 95°.

**SOFT-CLOSING MECHANISM**

**MOUVEMENT DE RETOUR** de la porte avec **AMORTISSEMENT**



Le ante dei contenitori dotate di serratura hanno chiave in duplice copia e coprichiave in ABS pieghevole antinfortunio.

The doors of lockable storage units come with two keys and folding ABS safety key cover.

Les portes des modules équipées de serrure ont deux jeux de clés et une coque de clé pliante en ABS.







## SPAZIO ARCHIVIAZIONE SOLUZIONE

...

## FINITURE ESCLUSIVE

Perfette rappresentanti dell'essenzialità ricercata del mondo dell'architettura e dell'interior design contemporanei.

Perfect models of refined basics, drawing on the world of contemporary architecture and interior design.

De parfaits représentants de l'essentialité recherchée qui habite le monde de l'architecture et de la décoration d'intérieur contemporaines.



Finitura in  
Penelope Argilla per i frontali

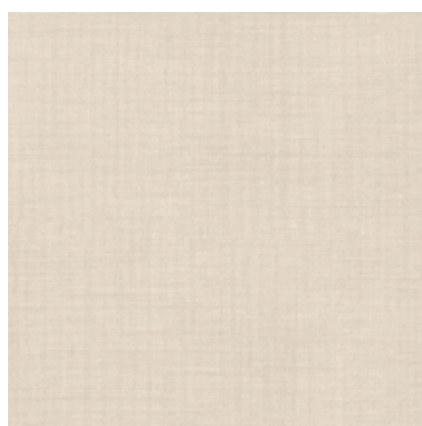

Finitura in Penelope Sabbia  
per il set Top/Spalle (optional)





- 342\_343 **TIPOLOGIA**
- 344\_345 **FINITURE**
- 346 **TIPOLOGIA ELEMENTI**
- 347\_349 **SPECIFICHE TECNICHE**
- 350\_351 **SOVRAPPOSIZIONE**

AREA TECNICA  
TECHNICAL AREA  
SECTION TECHNIQUE

...

ELEMENTI  
**CONTENITORI**

DESIGN by STUDIO IVM

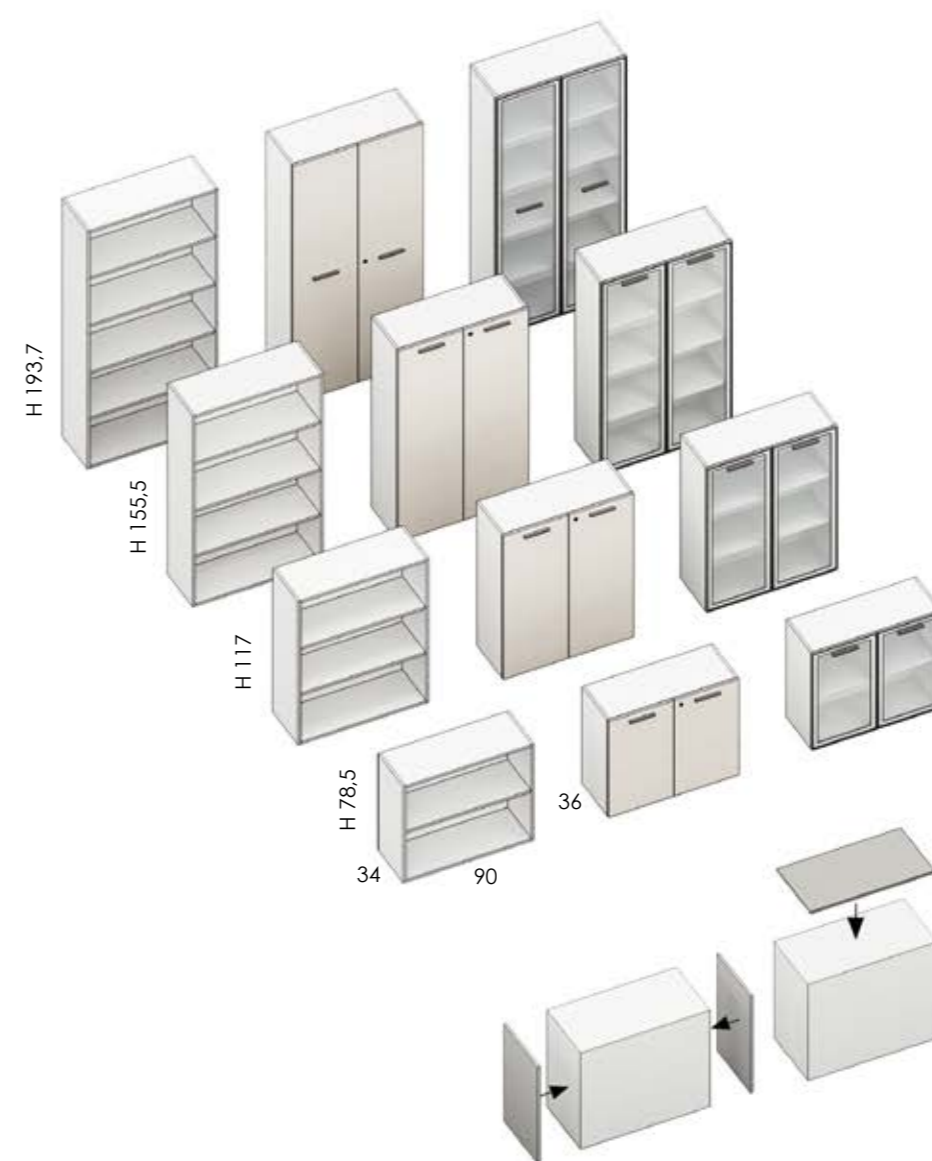
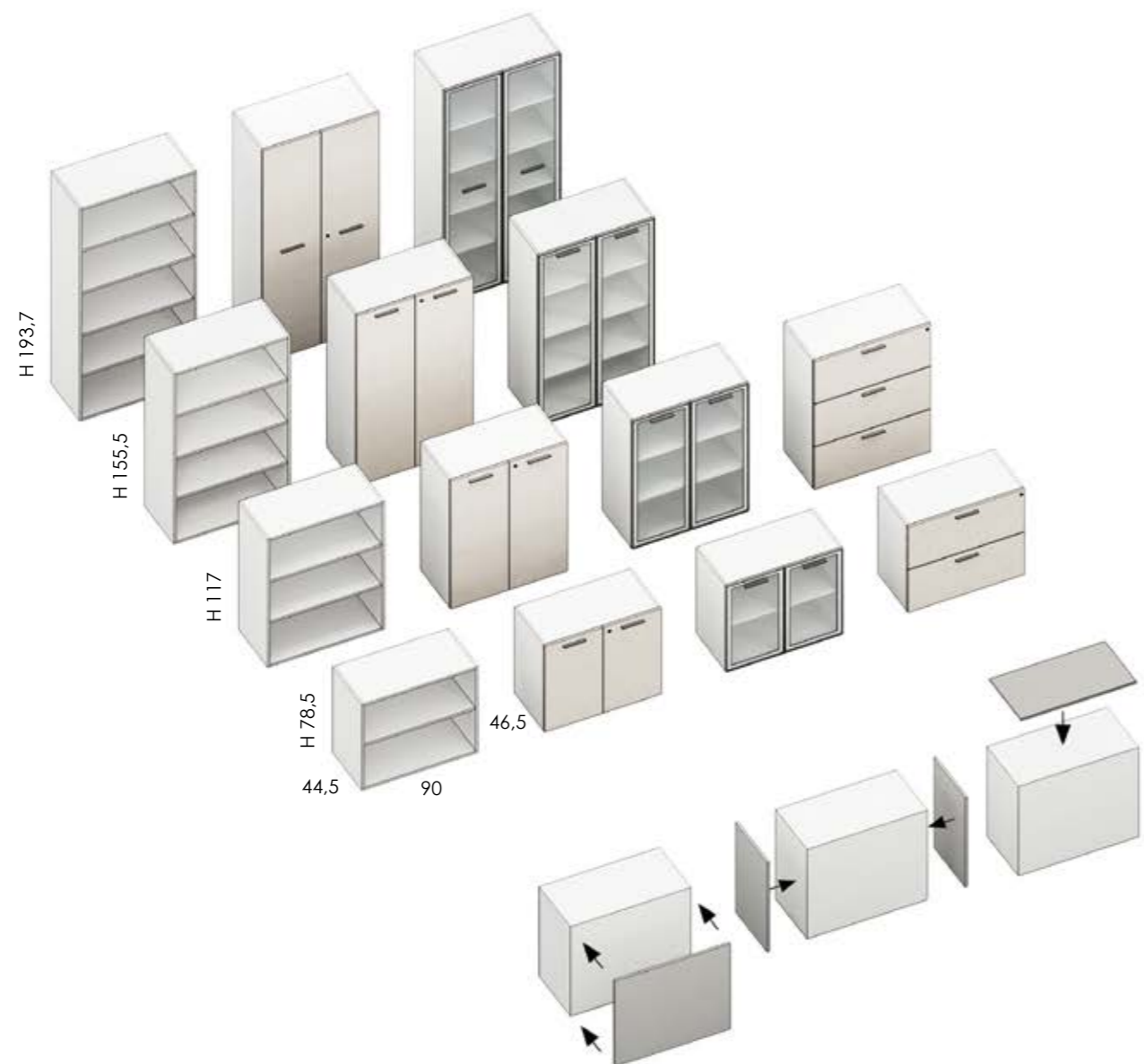
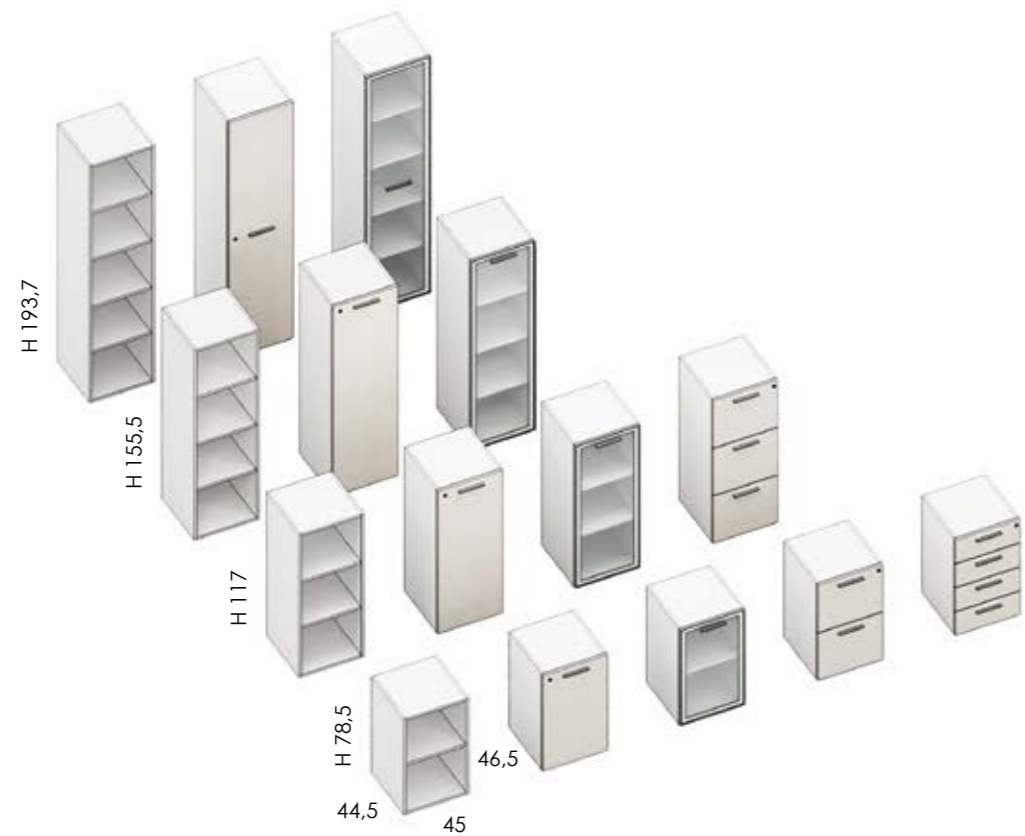

ELEMENTI **CONTENITORI**\_LE FINITURE

**SET DI FINITURA / OPTIONAL**

**SPALLE E TOP NOBILITATO** spess. 18 mm

SIDE AND TOP 18 mm THICK LAMINATED  
CÔTÉS ET TOP EN MÉLAMINÉ 18 mm ÉPAIS

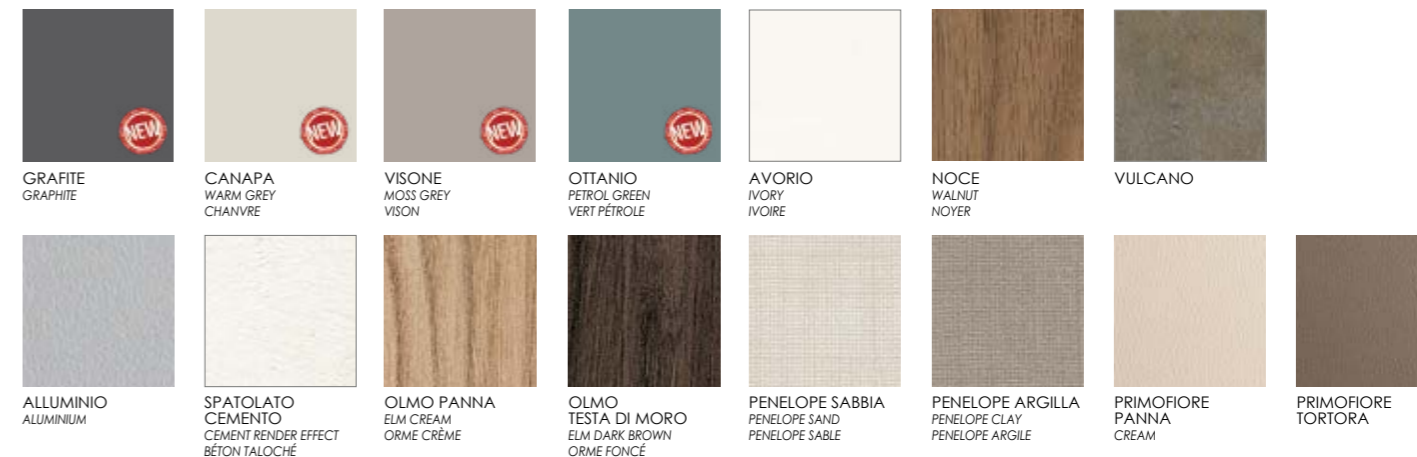

**FRONTALI NOBILITATO** ANTE, CASSETTI, CLASSIFICATORI - spess. 18 mm

LAMINATED FRONTS - DOORS, DRAWERS, FILING UNITS (18 mm THICK)  
FAÇADES EN MÉLAMINÉ - PORTES, TIROIRS, CLASSEURS - 18 mm ÉPAIS



**FRONTALI CRISTALLO** ANTE

GLASS FRONTS - DOORS  
FAÇADES EN VERRE - PORTES



**STRUTTURA** NOBILITATO

LAMINATED FRAME  
STRUCTURE MÉLAMINÉ



## SPECIFICHE TECNICHE ELEMENTI CONTENITORI

193,7

155,5

117

78,5



### TIPOLOGIA ELEMENTI

**PROFONDITÀ** cm 46,5 ANTE/CASSETTIERE/CLASSIFICATORI  
cm 44,5 VANO

cm 36 ANTE/CASSETTIERE/CLASSIFICATORI  
cm 34 VANO

**LARGHEZZA** cm 45/90

#### MANIGLIA STANDARD



MANIGLIA colore ALLUMINIO  
HANDLE colour ALUMINIUM  
POIGNÉE couleur ALUMINIUM

#### MANIGLIE OPTIONAL

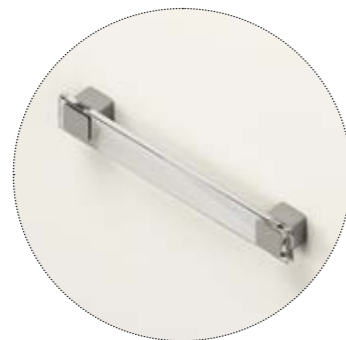

MANIGLIA FLY

MANIGLIA METRACRILATO  
trasparente



MANIGLIA WING

MANIGLIA METALLO  
finitura CROMO LUCIDO

### CASSETTIERE in MELAMINICO

Struttura realizzata in conglomerato ligneo spess. 18 mm, placcato da entrambi i lati nelle due varianti melaminico ALLUMINIO o AVORIO. Frontali realizzati in conglomerato ligneo spess. 18 mm nelle finiture nobilitato AVORIO, VULCANO, ALLUMINIO, NOCE, PENELOPE nei 2 colori disponibili (Sabbia, Argilla), SPATOLATO CEMENTO, OLMO (Testa di Moro, Panna), GRAFITE, CANAPA, VISIONE, OTTANIO. Top realizzati in conglomerato ligneo spess. 18 mm nelle finiture melaminico AVORIO, VULCANO, ALLUMINIO, NOCE, SPATOLATO CEMENTO, OLMO (Testa di Moro, Panna), GRAFITE, CANAPA, VISIONE, OTTANIO. Bordati in ABS forte spessore sui quattro lati in finitura identica alla superficie. Disponibili con cassetto interno in lamiera di metallo con guide metalliche ad estrazione semplice (per il cassetto) e ad estrazione totale (per il cassetto classificatore) o con cassetto interno ligneo rivestito in PVC nero con guide metalliche ad estrazione semplice. Serratura a chiusura simultanea di tutti i cassetti, con chiave in duplice copia e coprichiave in ABS pieghevole antinfortunio. Il cassetto classificatore è attrezzato per contenere cartelle sospese con interasse 33 cm. Ruote piroettanti in nylon nero.

### CASSETTIERE in METALLO

Realizzate in monoblocco di lamiera di acciaio, disponibili nelle due finiture BIANCO 9010 o ALLUMINIO 9006 (verniciate con polveri epossidiche). Maniglie in colore abbinato alla struttura. Cassetto interno in metallo montato su guide a sfera per una migliore scorrevolezza ed una minor rumorosità, ad estrazione semplice (per il cassetto) e ad estrazione totale (per il cassetto classificatore). Serratura a chiusura simultanea di tutti i cassetti, con sistema antiribaltamento (permette l'apertura di un cassetto per volta). Chiave in duplice copia e coprichiave in ABS pieghevole antinfortunio. Il cassetto classificatore è attrezzato per contenere cartelle sospese con interasse 33 cm. Ruote piroettanti in nylon nero.

### CONTENITORI in MELAMINICO - prof. 46,5

La tipologia prevede: contenitori a giorno, ante piene battenti, ante vetro battenti, cassetti e classificatori.

#### STRUTTURA

Struttura realizzata in conglomerato ligneo spess. 18 mm, placcato da entrambi i lati in melaminico ALLUMINIO o AVORIO resistente all'abrasione, cappello base e fianchi spess. 18 mm. Ripiani interni in metallo verniciati con polveri epossidiche in color ALLUMINIO o AVORIO, spess. 25 mm posizionabili liberamente (passo 32 mm). I ripiani sono predisposti per archiviazione di cartelle sospese. Schienale in conglomerato ligneo spess. 7 mm rivestito in PVC finitura ALLUMINIO e AVORIO.

#### TOP

Disponibili in conglomerato ligneo spess. 18 mm, placcato da entrambi i lati in nobilitato AVORIO, ALLUMINIO, NOCE, SPATOLATO CEMENTO, PENELOPE (Sabbia, Argilla), PRIMOFIORE (Tortora, Panna), OLMO (Testa di Moro, Panna), GRAFITE, CANAPA, VISIONE, OTTANIO.

#### SPALLE DI FINITURA (opzionali)

Disponibili in conglomerato ligneo spess. 18 mm nelle finiture melaminico AVORIO, ALLUMINIO, NOCE, SPATOLATO CEMENTO, PENELOPE (Sabbia, Argilla), PRIMOFIORE (Tortora, Panna), OLMO (Testa di Moro, Panna), GRAFITE, CANAPA, VISIONE, OTTANIO.

#### ANTE LEGNO BATTENTI

In conglomerato ligneo spess. 18 mm, in nobilitato AVORIO, VULCANO, FELTRO, ALLUMINIO, NOCE, PENELOPE nei 2 colori (Sabbia, Argilla), SPATOLATO CEMENTO, PRIMOFIORE (Tortora, Panna), OLMO (Testa di Moro, Panna), GRAFITE, CANAPA, VISIONE, OTTANIO, bordato in ABS forte spessore sui quattro lati in finitura identica alla superficie. Dotate di serratura con chiave in duplice copia e coprichiave in ABS pieghevole antinfortunio. Le ante dei mobili h.195 sono dotate di serratura a cariglione. Cerniere regolabili apertura 95° gradi ad aggancio rapido. Maniglia colore Alluminio.

#### ANTE VETRO BATTENTI

Versione 'a telaio': cristallo temperato spessore 4 mm inserito in telaio perimetrale in estruso di alluminio; finitura dei cristalli in trasparente o retro verniciato nei colori MOKA, NERO; cerniere regolabili apertura a 95° - maniglia centrale come su ante legno - non dotabili di serratura.

#### CASSETTIERA

Realizzate in conglomerato ligneo spess. 18 mm, disponibili in melaminico AVORIO, ALLUMINIO, NOCE, PENELOPE nei 2 colori disponibili (Sabbia, Argilla), SPATOLATO CEMENTO, PRIMOFIORE (Tortora, Panna), OLMO (Testa di Moro, Panna), GRAFITE, CANAPA, VISIONE, OTTANIO, resistente all'abrasione. Cassetti interni spess. 12 mm rivestiti in PVC alluminio montati su guide in metallo, con movimento agevole e silenzioso. Maniglie in finitura Alluminio. I frontali dei cassetti NON possono essere dotati di serratura.

#### CLASSIFICATORI

Realizzati in conglomerato ligneo spess. 18 mm, disponibili in melaminico AVORIO, ALLUMINIO, NOCE, PENELOPE nei 2 colori disponibili (Sabbia, Argilla), SPATOLATO CEMENTO, PRIMOFIORE (Tortora, Panna), OLMO (Testa di Moro, Panna), GRAFITE, CANAPA, VISIONE, OTTANIO, resistente all'abrasione. Telai interni in metallo montati su guide telescopiche, portata kg. 45. Serratura a chiusura simultanea di tutti i classificatori, dotata di sistema antiribaltamento (permette l'apertura di un cassetto per volta). Chiave in duplice copia e coprichiave in ABS pieghevole antinfortunio. Il classificatore è attrezzato per contenere cartelle sospese interasse 330 e 390 mm. Maniglie in color Alluminio.

### CONTENITORI in MELAMINICO - prof. 36

La tipologia prevede: contenitori a giorno, ante piene battenti, ante vetro battenti, cassetti e classificatori.

#### STRUTTURA

Struttura realizzata in conglomerato ligneo spess. 18 mm, placcato da entrambi i lati in melaminico ALLUMINIO o AVORIO resistente all'abrasione. Cappello base e fianchi spess. 18 mm. Ripiani interni in melaminico nelle due varianti ALLUMINIO o AVORIO, spess. 22 mm, posizionabili liberamente (passo 32 mm). Schienale in conglomerato ligneo spess. 7 mm rivestito in PVC finitura ALLUMINIO.

#### TOP

In conglomerato ligneo spess. 18 mm, placcato da entrambi i lati in nobilitato AVORIO, ALLUMINIO, NOCE, SPATOLATO CEMENTO, PENELOPE (Sabbia, Argilla), PRIMOFIORE (Tortora, Panna), OLMO (Testa di Moro, Panna), GRAFITE, CANAPA, VISIONE, OTTANIO.

#### SPALLE DI FINITURA (opzionali)

Disponibili in conglomerato ligneo spess. 18 mm nelle finiture melaminico AVORIO, ALLUMINIO, NOCE, SPATOLATO CEMENTO, PENELOPE (Sabbia, Argilla), PRIMOFIORE (Tortora, Panna), OLMO (Testa di Moro, Panna), GRAFITE, CANAPA, VISIONE, OTTANIO.

#### ANTE LEGNO BATTENTI

In conglomerato ligneo spess. 18 mm, in nobilitato AVORIO, VULCANO, FELTRO, ALLUMINIO, NOCE, PENELOPE nei 2 colori (Sabbia, Argilla), SPATOLATO CEMENTO, PRIMOFIORE (Tortora, Panna), OLMO (Testa di Moro, Panna), GRAFITE, CANAPA, VISIONE, OTTANIO, bordato in ABS forte spessore sui quattro lati in finitura identica alla superficie. Dotate di serratura con chiave in duplice copia e coprichiave in ABS pieghevole antinfortunio. Le ante dei mobili h.195 sono dotate di serratura a cariglione. Cerniere regolabili apertura 95° ad aggancio rapido. Maniglia colore Alluminio.

#### ANTE VETRO BATTENTI

Versione 'a telaio': cristallo temperato spess. 4 mm inserito in telaio perimetrale in estruso di alluminio; finitura dei cristalli in trasparente o retro verniciato nei colori MOKA, NERO; cerniere regolabili apertura a 95° - maniglia centrale come su ante legno - non dotabili di serratura.

Tutti i materiali utilizzati sono conformi alle norme UNI EN e sono certificati per il 90% CARB 2 (relativamente all'emissione di formaldeide).

## STORAGE UNITS TECHNICAL SPECIFICATIONS

### MELAMINE DRAWER UNITS

Structure in 18 mm-thick wood conglomerate, veneered on both sides in the two melamine variants of ALUMINIUM or IVORY. Fronts built from 18 mm-thick wood laminate in the following finishes: IVORY, VULCANO, ALUMINIUM, WALNUT, PENELOPE, 2 different colours available (Sand, Clay), CEMENT RENDER EFFECT, ELM (Dark Brown, Cream), GRAPHITE, WARM GREY, MOSS GREY, PETROL GREEN. Top built from 18 mm-thick wood conglomerate in the melamine finishes of IVORY, VULCANO, ALUMINIUM, WALNUT, CEMENT RENDER EFFECT, ELM (Dark Brown, Cream), GRAPHITE, WARM GREY, MOSS GREY, PETROL GREEN. Edged in extra thick ABS on all sides; finish identical to the top. Available with inner metal sheet drawer on metal runners for standard sliding (the drawer) and complete removal (filing cabinet drawer), or with a wooden inner drawer lined in black PVC with standard sliding metal runners. Simultaneous locking on all drawers, with two copies of keys with accident-proof folding ABS key cover. The filing cabinet drawer is designed to fit hanging files with a 33 cm width. Black nylon pirouette wheels.

### METAL DRAWER UNIT

Enbloc steel plate available in the two system colourway finishes of 9010 WHITE or 9006 ALUMINIUM (painted with epoxy powders). Handle colour matches the structure. The internal metal drawer is fitted to two ball runners for better sliding and less noise, standard sliding (for the drawer) and completely removable (filing cabinet drawer). Simultaneous locking on all drawers, with anti-tipping system (for opening one drawer at a time). Two copies of keys with accident-proof folding ABS key cover. The filing cabinet drawer is designed to fit hanging files with a 33 cm width. Black nylon pirouette wheels.

### MELAMINE CONTAINER UNITS - depth 46,5

The line includes: open containers, full and glass panel doors; drawers and a filing system.

#### STRUCTURE

Structure built from 18 mm-thick wood conglomerate, veneered on both sides in the melamine variants of ALUMINIUM or IVORY, abrasion-resistant, 18 mm-thick top, base and sides. The 25 mm-thick metal inner shelves are in epoxy powder ALUMINIUM or IVORY colour finish and can be positioned freely (32 mm pitch). The shelves are designed to fit hanging files. 7 mm-thick wood conglomerate back panel covered in PVC in an ALUMINIUM and IVORY finish.

#### TOP

Available in 18 mm-thick wood conglomerate, veneered on both sides in IVORY, ALUMINIUM, WALNUT, CEMENT RENDER EFFECT, PENELOPE (Sand, Clay), PRIMOFIORE (Tortora, Cream), ELM (Dark Brown, Cream), GRAPHITE, WARM GREY, MOSS GREY, PETROL GREEN.

#### FINISHING SIDE PANELS (optional)

Available in 18 mm-thick wood conglomerate in the melamine finishes of IVORY, ALUMINIUM, WALNUT, CEMENT RENDER EFFECT, PENELOPE (Sand, Clay), PRIMOFIORE (Tortora, Cream), ELM (Dark Brown, Cream), GRAPHITE, WARM GREY, MOSS GREY, PETROL GREEN finish.

#### WOODEN PANEL DOORS

In 18 mm-thick wood conglomerate, in laminated IVORY, VULCANO, FELT, ALUMINIUM, WALNUT, PENELOPE in 2 different colours (Sand, Clay), CEMENT RENDER EFFECT, PRIMOFIORE (Tortora, Cream), ELM (Dark Brown, Cream), GRAPHITE, WARM GREY, MOSS GREY, PETROL GREEN edged in extra-thick ABS on all sides with the same finish as the surface. Supplied with two copies of keys with accident-proof folding ABS key cover. In the 195 height the lock is fitted with a ratchet. Adjustable hinge 95° opening with quick fit. Aluminium colour handle.

#### GLASS PANEL DOORS

'Frame' version: 4 mm-thick tempered glass inserted into a perimeter frame in extruded aluminium; transparent or back-painted glass in the colours MOCHA COFFEE or BLACK; adjustable hinge with 95° opening; central handle as for wooden door; cannot be fitted with a lock.

#### DRAWER UNIT

Built from 18 mm-thick wood conglomerate, available in the melamine variants of IVORY, ALUMINIUM, PENELOPE available in 2 different abrasion-resistant colours (Sand, Clay), CEMENT RENDER EFFECT, PRIMOFIORE (Tortora, Cream), ELM (Dark Brown, Cream), GRAPHITE, WARM GREY, MOSS GREY, PETROL GREEN. 12 mm-high internal drawers with PVC aluminium colour finish; metal runner with smooth, silent movement. Aluminium finish handle. Drawer fronts DO NOT fit locks.

#### FILING SYSTEMS

Built from 18 mm-thick wood conglomerate, available in the melamine variants of IVORY, ALUMINIUM, PENELOPE available in 2 different abrasion-resistant colours (Sand, Clay), CEMENT RENDER EFFECT, PRIMOFIORE (Tortora, Cream), ELM (Dark Brown, Cream), GRAPHITE, WARM GREY, MOSS GREY, PETROL GREEN. Internal metal frames fitted to telescopic runners with 45 kg capacity. Simultaneous locking on all filing units with anti-tipping system (for opening one drawer at a time). Two copies of keys with accident-proof folding ABS key cover. The filing cabinet drawer is designed to fit hanging files, with a 33 cm width. Aluminium colour handle.

### MELAMINE CONTAINER UNITS - depth 36

The line includes: open containers; with full and glass panel doors; drawers and a filing system.

#### STRUCTURE

Structure in 18 mm-thick wood conglomerate, veneered on both sides in the abrasion-resistant melamine variants of ALUMINIUM or IVORY. 18 mm-thick top, base and sides. 22 mm-thick ALUMINIUM or IVORY melamine inner shelves that can be freely positioned (32 mm pitch). 7 mm-thick wood conglomerate back panel covered in PVC in an ALUMINIUM finish.

#### TOP

In 18 mm-thick wood conglomerate, veneered on both sides in IVORY, ALUMINIUM, WALNUT, CEMENT RENDER EFFECT, PENELOPE (Sand, Clay), PRIMOFIORE (Tortora, Cream), ELM (Dark Brown, Cream), GRAPHITE, WARM GREY, MOSS GREY, PETROL GREEN laminates finish.

#### FINISHING SIDE PANELS (optional)

Available in 18 mm-thick wood conglomerate in the melamine finishes of IVORY, ALUMINIUM, WALNUT, CEMENT RENDER EFFECT, PENELOPE (Sand, Clay), PRIMOFIORE (Tortora, Cream), ELM (Dark Brown, Cream), GRAPHITE, WARM GREY, MOSS GREY, PETROL GREEN finish.

#### WOODEN PANEL DOORS

In 18 mm-thick wood conglomerate, available in a CANALETTO WALNUT veneer, or in laminated IVORY, VULCANO, FELT, ALUMINIUM, WALNUT, PENELOPE in 2 different colours (Sand, Clay), CEMENT RENDER, PRIMOFIORE (Tortora, Cream), ELM (Dark Brown, Cream), GRAPHITE, WARM GREY, MOSS GREY, PETROL GREEN. Edged in extra-thick ABS on all sides with the same finish as the surface. Supplied with two copies of keys with accident-proof folding ABS key cover. In the 195 height the lock is fitted with a ratchet. Adjustable hinge 95° opening with quick fit. Aluminium colour handle.

#### GLASS PANEL DOORS

'Frame' version: 4 mm-thick tempered glass inserted into a perimeter frame in extruded aluminium; transparent or back-painted glass in the colours MOCHA COFFEE or BLACK; adjustable hinge with 95° opening; central handle as for wooden door; cannot be fitted with a lock.

**All materials used comply with UNI EN standards, and 90% of its production is certified to CARB 2 (formaldehyde emissions).**

## SPÉCIFICATIONS TECHNIQUES ARMOIRES

### CAISSONS en MELAMINE

Structure réalisée en bois aggloméré d'une épaisseur de 18 mm, plaqué sur les deux côtés dans les variantes ALUMINIUM ou IVOIRE. Façades réalisées en bois aggloméré de 18 mm d'épaisseur, dans les finitions en mélaminé IVOIRE, VULCANO, ALUMINIUM, NOYER, PENELOPE dans les 2 couleurs disponibles (Sable, Argile), BÉTON TALOCHÉ, ORME (Foncé, Crème), GRAPHITE, CHANVRE, VISON, VERT PÉTOLE. Tops réalisés en bois aggloméré d'une épaisseur de 18 mm dans les finitions en mélaminé IVOIRE, VULCANO, ALUMINIUM, NOYER, BÉTON TALOCHÉ, ORME (Foncé, Crème), GRAPHITE, CHANVRE, VISON, VERT PÉTOLE. Bordées en ABS de forte épaisseur sur quatre côtés en finition identique à celle de la surface. Disponibles avec un tiroir intérieur en tôle de métal, avec des glissières en métal à extraction simple (pour le tiroir) et à extraction complète (pour le tiroir classeur) ou avec un tiroir intérieur en bois revêtu de PVC noir avec des glissières en métal à extraction simple. Serrure à fermeture simultanée de tous les tiroirs, avec deux clés et couvre-clé en ABS pliant anti-accidents. Le tiroir classeur est équipé pour contenir des dossiers suspendus avec un écartement de 33 cm. Roues pivotantes en nylon noir.

### CAISSONS en METAL

Réalisés en monobloc de tôle en acier, disponibles dans les deux finitions BLANC 9010 ou ALUMINIUM 9006 (peintes avec des poudres époxydiques). Poignées d'une couleur assortie à la structure. Tiroir intérieur en métal monté sur des glissières à sphère garantissant un meilleur coulissement et une réduction du bruit, à extraction simple (pour le tiroir) et à extraction totale (pour le tiroir classeur). Serrure à fermeture simultanée de tous les tiroirs, avec système anti-renversement (permet d'ouvrir un seul tiroir à la fois). Clé en deux copies et couvre-clé en ABS pliant de sécurité. Le tiroir classeur est équipé pour contenir des dossiers suspendus avec un écartement de 33 cm. Roues pivotantes en nylon noir.

### ARMOIRES en MELAMINE - prof. 46,5

Cette catégorie prévoit des armoires ouvertes, à portes battantes pleines, portes battantes en verre, avec tiroirs et classeurs.

#### STRUCTURE

Structure réalisée en bois aggloméré de 18 mm d'épaisseur, plaqué sur les deux côtés en mélaminé ALUMINIUM ou IVOIRE résistant à l'abrasion, dessus, base et flancs de 18 mm d'épaisseur. Etagères intérieures en métal peint avec des poudres époxydiques en couleur ALUMINIUM ou IVOIRE de 25 mm d'épaisseur, à agencer librement (écartement 32 mm). Les étagères sont prévues pour le rangement de dossiers suspendus. Dos en bois aggloméré de 7 mm d'épaisseur. Revetu en PVC finition ALUMINIUM ou IVOIRE.

#### TOP

Disponibles en bois aggloméré de 18 mm d'épaisseur, plaqué sur les deux côtés en mélaminé IVOIRE, ALUMINIUM, NOYER, BÉTON TALOCHÉ, PENELOPE (Sable, Argile), PRIMOFIORE (Tortora, Crème), ORME (Foncé, Crème), GRAPHITE, CHANVRE, VISON, VERT PÉTOLE.

#### MONTANTS DE FINITION (options)

Disponibles en bois aggloméré de 18 mm d'épaisseur, dans les finitions en mélaminé IVOIRE, ALUMINIUM, CHENE BLANCHI, NOYER ou en mélaminé verni transparent en NOYER CANALETTO, BÉTON TALOCHÉ, PENELOPE (Sable, Argile), PRIMOFIORE (Tortora, Crème), ORME (Foncé, Crème), GRAPHITE, CHANVRE, VISON, VERT PÉTOLE.

#### PORTES BATTANTES en BOIS

En bois aggloméré de 18 mm d'épaisseur, en mélaminé IVOIRE, VULCANO, FEUTRE, ALUMINIUM, NOYER, PENELOPE dans les 2 couleurs (Sable, Argile), BÉTON TALOCHÉ, PRIMOFIORE (Tortora, Crème), ORME (Foncé, Crème), GRAPHITE, CHANVRE, VISON, VERT PÉTOLE avec bord en ABS de forte épaisseur sur quatre côtés, dans une finition identique à la surface. Munies d'une clé en deux copies et d'un couvre-clé en ABS pliant de sécurité. Les portes des meubles h. 195 sont munies de serrures à crémone. Charnières réglables à ouverture à 95° degrés, à enclenchement rapide. Poignée de couleur Aluminium.

#### PORTES BATTANTES en VERRE

Version à châssis : verre trempé de 4 mm d'épaisseur, inséré dans un châssis de pourtour en aluminium extrudé : finition des verres transparente ou peinture sur revers en couleur MOKA, NOIR; charnières réglables à ouverture à 95° - poignée centrale comme sur les portes en bois - NE peuvent PAS être munies de serrures.

#### CAISSON

Réalisé en bois aggloméré de 18 mm d'épaisseur, disponibles en mélaminé IVOIRE, ALUMINIUM, NOYER, PENELOPE dans les 2 couleurs disponibles (Sable, Argile), BÉTON TALOCHÉ, PRIMOFIORE (Tortora, Crème), ORME (Foncé, Crème), GRAPHITE, CHANVRE, VISON, VERT PÉTOLE résistant à l'abrasion. Tiroirs intérieurs de 12 mm d'épaisseur, revêtus de PVC aluminium montés sur des glissières en métal à mouvement aisé et silencieux. Poignées en finition aluminium. Les façades des tiroirs NE peuvent PAS être munies de serrure.

#### CLASSEURS

Réalisés en bois aggloméré de 18 mm d'épaisseur, disponibles en mélaminé IVOIRE, ALUMINIUM, NOYER, PENELOPE dans les 2 couleurs disponibles (Sable, Argile), BÉTON TALOCHÉ, PRIMOFIORE (Tortora, Crème), ORME (Foncé, Crème), GRAPHITE, CHANVRE, VISON, VERT PÉTOLE résistant à l'abrasion. Châssis intérieurs en métal montés sur des glissières télescopiques, charge de 45 Kg. Serrure à fermeture simultanée de tous les classeurs, avec système anti-renversement (permet d'ouvrir un seul tiroir à la fois). Clé en deux copies et couvre-clé en ABS pliant de sécurité. Le classeur est équipé pour contenir des dossiers suspendus avec un écartement de 330 et 390 mm. Poignées de couleur Aluminium.

### ARMOIRES en MELAMINE - prof. 36

Cette catégorie prévoit des armoires ouvertes, à portes battantes pleines, portes battantes en verre, avec tiroirs et classeurs.

#### STRUCTURE

Structure réalisée en bois aggloméré de 18 mm d'épaisseur, plaqué sur les deux côtés en mélaminé ALUMINIUM ou IVOIRE, résistant à l'abrasion. Dessus, base et flancs de 18 mm d'épaisseur. Etagères intérieures en mélaminé dans les deux variantes ALUMINIUM ou IVOIRE, ép. : 22 mm, à agencer librement (écartement : 32 mm). Dos en bois aggloméré de 7 mm d'épaisseur revêtu en PVC finition ALUMINIUM.

#### TOP

En bois aggloméré de 18 mm d'épaisseur, plaqué sur les deux côtés en mélaminé IVOIRE, ALUMINIUM, NOYER, BÉTON TALOCHÉ, PENELOPE (Sable, Argile), PRIMOFIORE (Tortora, Crème), ORME (Foncé, Crème), GRAPHITE, CHANVRE, VISON, VERT PÉTOLE.

#### MONTANTS DE FINITION (options)

Disponibles en bois aggloméré de 18 mm d'épaisseur, dans les finitions en mélaminé IVOIRE, ALUMINIUM, NOYER, BÉTON TALOCHÉ, PENELOPE (Sable, Argile), PRIMOFIORE (Tortora, Crème), ORME (Foncé, Crème), GRAPHITE, CHANVRE, VISON, VERT PÉTOLE.

#### PORTES BATTANTES en BOIS

En bois aggloméré de 18 mm d'épaisseur, disponibles en mélaminé IVOIRE, VULCANO, FEUTRE, ALUMINIUM, NOYER, PENELOPE dans les 2 couleurs (Sable, Argile), BÉTON TALOCHÉ, PRIMOFIORE (Tortora, Crème), ORME (Foncé, Crème), GRAPHITE, CHANVRE, VISON, VERT PÉTOLE avec bord en ABS de forte épaisseur sur quatre côtés, dans une finition identique à la surface. Munies d'une clé en deux copies et d'un couvre-clé en ABS pliant de sécurité. Les portes des meubles h. 195 sont munies de serrures à crémone. Charnières réglables à ouverture à 95° degrés, à enclenchement rapide. Poignée de couleur Aluminium.

#### PORTES BATTANTES en VERRE

Version à châssis : verre trempé de 4 mm d'épaisseur inséré dans un châssis de pourtour en aluminium extrudé : finition des verres transparente ou peinture sur revers en couleur MOKA, NOIR; charnières réglables à ouverture à 95° - poignée centrale comme sur les portes en bois - NE peuvent PAS être munies de serrure.

**Tous les matériaux employés sont conformes aux normes UNI EN et sont certifiés CARB 2 (concernant l'émission de formaldéhyde) pour 90 % de la production.**

ELEMENTI CONTENITORI PROF44,5\_46,5  
POSSIBILI CONFIGURAZIONI IN SOVRAPPOSIZIONE

I MODULI SOVRAPPONIBILI

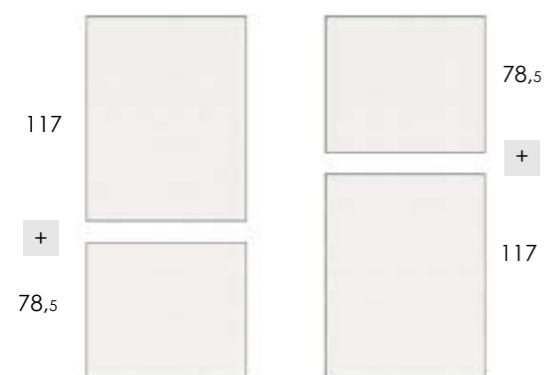

I MODULI SOVRAPPONIBILI

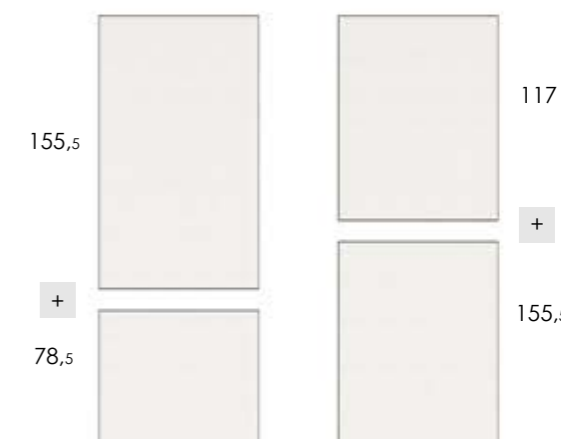
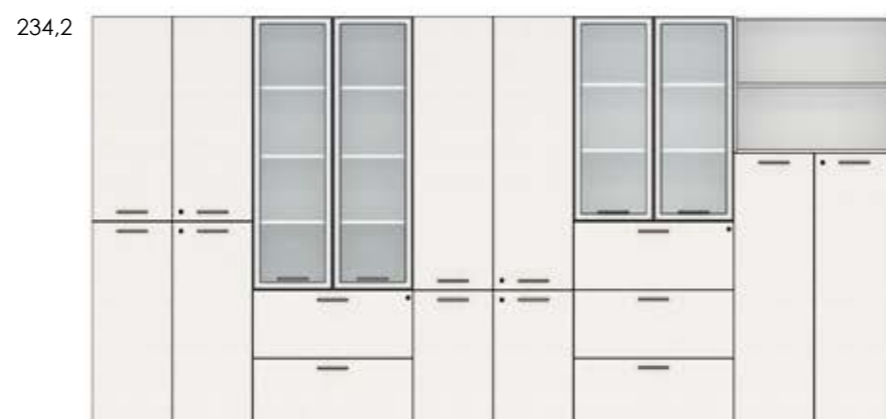
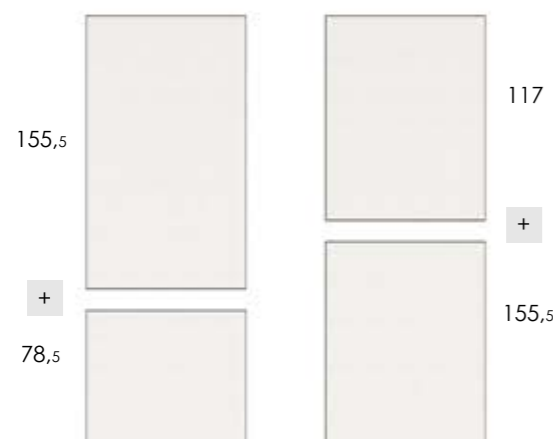
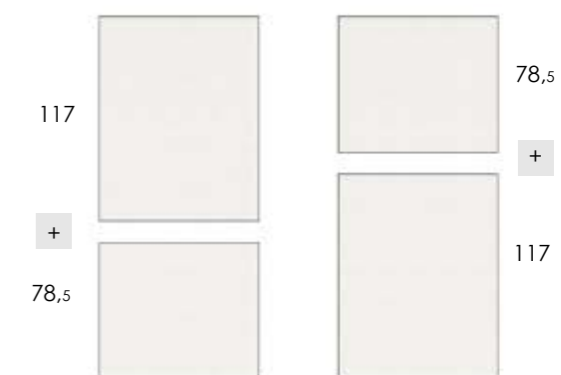

Le ante dei contenitori dotate di serratura hanno chiave in duplice copia e coprichiave in ABS pieghevole antinfortunio.  
The doors of lockable storage units come with two keys and folding ABS safety key cover.  
Les portes des modules équipées de serrure ont deux jeux de clés et une coque de clé pliante en ABS.

CERNIERE REGOLABILI  
apertura a 95°  
ad aggancio rapido.  
ADJUSTABLE,  
quick-mounting HINGE  
(95° opening).  
PAUMELLES RÉGLABLES  
ouverture à 95°  
pour montage rapide.

CLASSIFICATORE con TELAI INTERNI  
in metallo montati su guide  
telescopiche - portata 45 Kg.  
Il classificatore è attrezzato  
per contenere cartelle sospese  
interasse 330 e 390 mm

FILING UNIT with metal hanging FOLDER  
FRAME mounted on telescopic slides -  
load capacity 45 kg.  
The filing unit can hold 330 - 390 mm  
suspension files/hanging folders.

CLASSEUR avec BÂTIS INTERNES en  
métal montés sur guides télescopiques -  
capacité 45 Kg.  
Le classeur est équipé pour accueillir  
des dossiers suspendus avec un entraxe  
de 330 et 390 mm.

Le ante dei contenitori h.193,7  
sono dotate di serratura a cariglione.  
The doors of the 193.7-high storage units  
are fitted with a multi-point rod lock.  
Les portes des modules h 193,7 sont équipées  
de serrures à crémone.



Nel 2011, con un investimento di 2.500.000 euro, sulla sede produttiva di Lissone, IVM ha installato un impianto fotovoltaico formato da 3.600 pannelli, offrendo così un significativo contributo alla riduzione dello sfruttamento delle risorse naturali. L'energia solare prodotta ci permette inoltre di ridurre le emissioni di CO2 in maniera considerevole mantenendo l'ambiente più pulito.

With an investment of 2,500,000 euros in 2011, IVM installed a photovoltaic system at its Lissone production site, consisting of 3,600 panels. This represents a significant step towards reducing the exploitation of natural resources. The solar energy produced also allows us to significantly reduce CO2 emissions, keeping the environment cleaner.

En 2011, avec un investissement de 2 500 000 euros, IVM a installé sur son usine de Lissone, un système photovoltaïque formé de 3 600 panneaux, contribuant ainsi de manière significative à la réduction de l'exploitation des ressources naturelles. L'énergie solaire produite nous permet par ailleurs de réduire considérablement les émissions de CO2 en préservant l'environnement.

COMPANY SHOWROOM



LISSONE\_MONZA&BRIANZA  
PRODUCTION SITE\_50.000 MQ



LISSONE\_MONZA&BRIANZA  
COMPANY SHOWROOM\_3.000 MQ

Una location suggestiva, realizzata in quella che è stata la prima sede produttiva, che mantiene le architetture originali e che si integra alle collezioni con grande fascino espositivo.

Un vero e proprio percorso di 3.000 m² che "rivela" la filosofia dell'azienda.

A suggestive location, built on what was the very first production site, which has kept the original architecture, fitting in with the collections and displaying them with great impact.

A real tour that reveals the company philosophy in 3,000 m².



... company showroom



PRODUCT BADGE  
con la sintesi dei crediti acquisiti

I SISTEMI di ARREDO e di PARETE IVM contribuiscono alle performance energetiche, ambientali, di comfort e salubrità di un edificio o parte di esso; in particolare soddisfano i requisiti richiesti dal sistema di rating LEED® (Leadership in Energy and Environmental Design), sistema internazionale che certifica la sostenibilità degli edifici.

The IVM FURNITURE and PARTITIONING SYSTEMS therefore help to improve the energy, environmental, comfort and health performance of a building or part of a building; in particular, they meet the rating requirements of LEED® (Leadership in Energy and Environmental Design), an international green building certification system.

LES SYSTÈMES de MOBILIER et de CLOISONS IVM contribuent aux performances énergétiques, environnementales, de confort et de salubrité d'un bâtiment ou d'une partie d'un bâtiment ; en particulier ils satisfont les exigences du système d'évaluation LEED® (Leadership in Energy and Environmental Design), un système international qui certifie la durabilité des bâtiments.

CERTIFICAZIONI

IVM è un'Azienda in possesso di Certificazione ISO 9001:2015  
IVM is certified to ISO 9001:2015  
IVM est une entreprise qui possède la certification ISO 9001:2015

IVM è un'Azienda in possesso di Certificazione Ambientale ISO 14001:2015  
IVM is certified to ISO 14001:2015 (Environmental certification)  
IVM est une entreprise qui possède la certification environnement ISO 14001:2015

IVM utilizza per la sua produzione pannelli certificati CARB P2 TSCA Title VI compliant  
IVM uses CARB P2 TSCA Title VI compliant certified panels for its production  
IVM utilise des panneaux labellisés CARB P2 TSCA Title VI compliant pour sa production

IVM è un'Azienda con passaporto del mobile MADE in BRIANZA rilasciato dalla camera di commercio Monza Brianza  
IVM has a MADE in BRIANZA furniture passport issued by the Monza Brianza Chamber of Commerce  
IVM est une entreprise qui possède le passeport du mobilier MADE in BRIANZA délivré par la Chambre de commerce de Monza Brianza

IVM adotta e promuove le norme e i propri principi aziendali attraverso il CODICE ETICO  
IVM adopts and promotes its corporate standards and principles through the CODE OF ETHICS  
IVM adopte et promeut ses normes et principes d'entreprise à travers le CODE DE DÉONTOLOGIE



UNI EN ISO 14001



UNI EN ISO 9001



PASSAPORTO del MOBILE



CODICE ETICO

Art Direction  
Progetto Grafico \_Rita Salogni

Elaborazione  
Fotolito \_Overscan

Stampa \_Mastergraph  
\_02/2023